

## ADC122S051/ADC122S051Q 2 Channel, 200 ksps to 500 ksps 12-Bit A/D Converter

Check for Samples: [ADC122S051](#)

### FEATURES

- Specified Over a Range of Sample Rates.
- Two Input Channels
- Variable Power Management
- Single Power Supply with 2.7V - 5.25V Range
- Tested per AEC-Q100 and Qualified for Automotive Applications
- Meets AEC-Q100-011 C2 CDM Classification

### APPLICATIONS

- Portable Systems
- Remote Data Acquisition
- Instrumentation and Control Systems

### KEY SPECIFICATIONS

- DNL: +0.7 / -0.4 LSB (typ)
- INL: ± 0.50 LSB (typ)
- SNR: 72.5 dB (typ)
- Power Consumption:
  - 3V Supply: 3.0 mW (typ)
  - 5V Supply: 10 mW (typ)

### DESCRIPTION

The ADC122S051/ADC122S051Q is a low-power, two-channel CMOS 12-bit analog-to-digital converter with a high-speed serial interface. Unlike the conventional practice of specifying performance at a single sample rate only, the ADC122S051/ADC122S051Q is fully specified over a sample rate range of 200 ksps to 500 ksps. The converter is based on a successive-approximation register architecture with an internal track-and-hold circuit. It can be configured to accept one or two input signals at inputs IN1 and IN2.

The output serial data is straight binary, and is compatible with several standards, such as SPI™, QSPI™, MICROWIRE, and many common DSP serial interfaces.

The ADC122S051/ADC122S051Q operates with a single supply that can range from +2.7V to +5.25V. Normal power consumption using a +3V or +5V supply is 3.0 mW and 10 mW, respectively. The power-down feature reduces the power consumption to just 0.14 μW using a +3V supply, or 0.32 μW using a +5V supply.

The ADC122S051/ADC122S051Q is packaged in an 8-lead VSSOP package. Operation over the industrial temperature range of -40°C to +85°C is specified.

**Table 1. Pin-Compatible Alternatives by Resolution and Speed<sup>(1)</sup>**

Resolution	Specified for Sample Rate Range of:		
	50 to 200 ksps	200 to 500 ksps	500 ksps to 1 Msps
12-bit	ADC122S021	<b>ADC122S051</b>	ADC122S101
10-bit	ADC102S021	ADC102S051	ADC102S101
8-bit	ADC082S021	ADC082S051	ADC082S101

(1) All devices are fully pin and function compatible.

### Connection Diagram

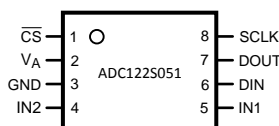

Please be aware that an important notice concerning availability, standard warranty, and use in critical applications of Texas Instruments semiconductor products and disclaimers thereto appears at the end of this data sheet.

All trademarks are the property of their respective owners.

**Block Diagram**

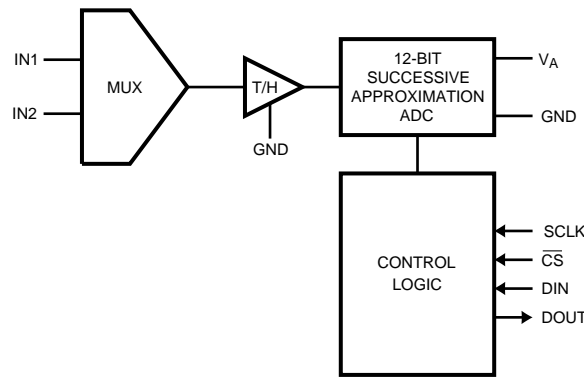

**PIN DESCRIPTIONS and EQUIVALENT CIRCUITS**

Pin No.	Symbol	Description
<b>ANALOG I/O</b>		
5,4	IN1 and IN2	Analog inputs. These signals can range from 0V to $V_A$ .
<b>DIGITAL I/O</b>		
8	SCLK	Digital clock input. This clock directly controls the conversion and readout processes.
7	DOUT	Digital data output. The output samples are clocked out of this pin on falling edges of the SCLK pin.
6	DIN	Digital data input. The ADC122S051/ADC122S051Q's Control Register is loaded through this pin on rising edges of the SCLK pin.
1	$\overline{CS}$	Chip select. On the falling edge of $\overline{CS}$ , a conversion process begins. Conversions continue as long as $\overline{CS}$ is held low.
<b>POWER SUPPLY</b>		
2	$V_A$	Positive supply pin. This pin should be connected to a quiet +2.7V to +5.25V source and bypassed to GND with a 1 $\mu$ F capacitor and a 0.1 $\mu$ F monolithic capacitor located within 1 cm of the power pin.
3	GND	The ground return for the die.



These devices have limited built-in ESD protection. The leads should be shorted together or the device placed in conductive foam during storage or handling to prevent electrostatic damage to the MOS gates.

**Absolute Maximum Ratings<sup>(1)(2)(3)</sup>**

Analog Supply Voltage $V_A$		-0.3V to 6.5V
Voltage on Any Pin to GND		-0.3V to $V_A + 0.3V$
Input Current at Any Pin <sup>(4)</sup>		±10 mA
Package Input Current <sup>(4)</sup>		±20 mA
Power Consumption at $T_A = 25^\circ\text{C}$		See <sup>(5)</sup>
ESD Susceptibility <sup>(6)</sup>	Human Body Model	2500V
	Machine Model	250V
	Charged Device Model	500V
Junction Temperature		+150°C
Storage Temperature		-65°C to +150°C

- (1) Absolute Maximum Ratings indicate limits beyond which damage to the device may occur. Operating Ratings indicate conditions for which the device is functional, but do not ensure specific performance limits. For ensured specifications and test conditions, see the Electrical Characteristics. The ensured specifications apply only for the test conditions listed. Some performance characteristics may degrade when the device is not operated under the listed test conditions.
- (2) If Military/Aerospace specified devices are required, please contact the Texas Instruments Sales Office/ Distributors for availability and specifications.
- (3) All voltages are measured with respect to GND = 0V, unless otherwise specified.
- (4) When the input voltage at any pin exceeds the power supply (that is,  $V_{IN} < \text{GND}$  or  $V_{IN} > V_A$ ), the current at that pin should be limited to 10 mA. The 20 mA maximum package input current rating limits the number of pins that can safely exceed the power supplies with an input current of 10 mA to two. The Absolute Maximum Rating specification does not apply to the  $V_A$  pin. The current into the  $V_A$  pin is limited by the Analog Supply Voltage specification.
- (5) The absolute maximum junction temperature ( $T_{Jmax}$ ) for this device is 150°C. The maximum allowable power dissipation is dictated by  $T_{Jmax}$ , the junction-to-ambient thermal resistance ( $\theta_{JA}$ ), and the ambient temperature ( $T_A$ ), and can be calculated using the formula  $P_{DMAX} = (T_{Jmax} - T_A)/\theta_{JA}$ . The values for maximum power dissipation listed above will be reached only when the device is operated in a severe fault condition (e.g. when input or output pins are driven beyond the power supply voltages, or the power supply polarity is reversed). Obviously, such conditions should always be avoided.
- (6) Human body model is 100 pF capacitor discharged through a 1.5 kΩ resistor. Machine model is 220 pF discharged through zero ohms

**Operating Ratings<sup>(1)(2)</sup>**

Operating Temperature Range	$-40^\circ\text{C} \leq T_A \leq +85^\circ\text{C}$
$V_A$ Supply Voltage	+2.7V to +5.25V
Digital Input Pins Voltage Range	-0.3V to $V_A$
Clock Frequency	50 kHz to 16 MHz
Analog Input Voltage	0V to $V_A$

- (1) Absolute Maximum Ratings indicate limits beyond which damage to the device may occur. Operating Ratings indicate conditions for which the device is functional, but do not ensure specific performance limits. For ensured specifications and test conditions, see the Electrical Characteristics. The ensured specifications apply only for the test conditions listed. Some performance characteristics may degrade when the device is not operated under the listed test conditions.
- (2) All voltages are measured with respect to GND = 0V, unless otherwise specified.

**Package Thermal Resistance<sup>(1)</sup>**

Package	$\theta_{JA}$
8-lead VSSOP	250°C / W

- (1) Soldering process must comply with Reflow Temperature Profile specifications. Refer to [www.ti.com/packaging](http://www.ti.com/packaging). Reflow temperature profiles are different for lead-free and non-lead-free packages.

**ADC122S051/ADC122S051Q Converter Electrical Characteristics<sup>(1)(2)</sup>**

The following specifications apply for  $V_A = +2.7V$  to  $5.25V$ ,  $GND = 0V$ ,  $f_{SCLK} = 3.2$  MHz to  $8$  MHz,  $f_{SAMPLE} = 200$  kpsps to  $500$  kpsps,  $C_L = 35$  pF unless otherwise noted. **Boldface limits apply for  $T_A = T_{MIN}$  to  $T_{MAX}$** ; all other limits  $T_A = 25^\circ C$ .

Symbol	Parameter	Conditions	Typical	Limits <sup>(3)</sup>	Units
<b>STATIC CONVERTER CHARACTERISTICS</b>					
	Resolution with No Missing Codes			<b>12</b>	Bits
INL	Integral Non-Linearity		$\pm 0.5$	<b><math>\pm 1.1</math></b>	LSB (max)
DNL	Differential Non-Linearity		$+0.7$	<b>1.3</b>	LSB (max)
			$-0.4$	<b>-1.0</b>	LSB (min)
$V_{OFF}$	Offset Error		$+0.3$	<b><math>\pm 1.3</math></b>	LSB (max)
OEM	Channel to Channel Offset Error Match		$\pm 0.1$	<b><math>\pm 1.0</math></b>	LSB (max)
FSE	Full Scale Error		$-0.5$	<b><math>\pm 1.5</math></b>	LSB (max)
FSEM	Channel to Channel Full-Scale Error Match		$+0.01$	<b><math>\pm 1.0</math></b>	LSB (max)
<b>DYNAMIC CONVERTER CHARACTERISTICS</b>					
SINAD	Signal-to-Noise Plus Distortion Ratio	$V_A = +2.7$ to $5.25V$ $f_{IN} = 40.2$ kHz, $-0.02$ dBFS	72	<b>69.2</b>	dB (min)
SNR	Signal-to-Noise Ratio	$V_A = +2.7$ to $5.25V$ $f_{IN} = 40.2$ kHz, $-0.02$ dBFS	72.5	<b>70.6</b>	dB (min)
THD	Total Harmonic Distortion	$V_A = +2.7$ to $5.25V$ $f_{IN} = 40.2$ kHz, $-0.02$ dBFS	$-84$	<b><math>-75</math></b>	dB (max)
SFDR	Spurious-Free Dynamic Range	$V_A = +2.7$ to $5.25V$ $f_{IN} = 40.2$ kHz, $-0.02$ dBFS	86	<b>76</b>	dB (min)
ENOB	Effective Number of Bits	$V_A = +2.7$ to $5.25V$	11.7	<b>11.2</b>	Bits (min)
	Channel-to-Channel Crosstalk	$V_A = +5.25V$ $f_{IN} = 40.2$ kHz	$-86$		dB
IMD	Intermodulation Distortion, Second Order Terms	$V_A = +5.25V$ , $f_a = 40.161$ kHz, $f_b = 41.015$ kHz	$-87$		dB
	Intermodulation Distortion, Third Order Terms	$V_A = +5.25V$ $f_a = 40.161$ kHz, $f_b = 41.015$ kHz	$-88$		dB
FPBW	$-3$ dB Full Power Bandwidth	$V_A = +5V$	11		MHz
		$V_A = +3V$	8		MHz
<b>ANALOG INPUT CHARACTERISTICS</b>					
$V_{IN}$	Input Range		0 to $V_A$		V
$I_{DCL}$	DC Leakage Current		$\pm 0.02$	<b><math>\pm 1</math></b>	$\mu A$ (max)
$C_{INA}$	Input Capacitance	Track Mode	33		pF
		Hold Mode	3		pF
<b>DIGITAL INPUT CHARACTERISTICS</b>					
$V_{IH}$	Input High Voltage	$V_A = +5.25V$		<b>2.4</b>	V (min)
		$V_A = +3.6V$		<b>2.1</b>	V (min)
$V_{IL}$	Input Low Voltage			<b>0.8</b>	V (max)
$I_{IN}$	Input Current	$V_{IN} = 0V$ or $V_{IN} = V_A$	$\pm 0.02$	<b><math>\pm 10</math></b>	$\mu A$ (max)
$C_{IND}$	Digital Input Capacitance		2	<b>4</b>	pF (max)
<b>DIGITAL OUTPUT CHARACTERISTICS</b>					
$V_{OH}$	Output High Voltage	$I_{SOURCE} = 200 \mu A$	$V_A - 0.03$	<b><math>V_A - 0.5</math></b>	V (min)
		$I_{SOURCE} = 1$ mA	$V_A - 0.10$		V
$V_{OL}$	Output Low Voltage	$I_{SINK} = 200 \mu A$	0.02	<b>0.4</b>	V (max)
		$I_{SINK} = 1$ mA	0.1		V

(1) Min/max specification limits are specified by design, test, or statistical analysis.  
 (2) PPAP (Production Part Approval Process) documentation of the device technology, process and qualification is available from Texas Instruments upon request.  
 (3) Tested limits are specified to TI's AOQL (Average Outgoing Quality Level).

**ADC122S051/ADC122S051Q Converter Electrical Characteristics<sup>(1)(2)</sup> (continued)**

The following specifications apply for  $V_A = +2.7V$  to  $5.25V$ ,  $GND = 0V$ ,  $f_{SCLK} = 3.2$  MHz to  $8$  MHz,  $f_{SAMPLE} = 200$  ksps to  $500$  ksps,  $C_L = 35$  pF unless otherwise noted. **Boldface limits apply for  $T_A = T_{MIN}$  to  $T_{MAX}$** ; all other limits  $T_A = 25^\circ C$ .

Symbol	Parameter	Conditions	Typical	Limits <sup>(3)</sup>	Units
$I_{OZH}, I_{OZL}$	TRI-STATE Leakage Current		0.005	<b><math>\pm 1</math></b>	$\mu A$ (max)
$C_{OUT}$	TRI-STATE Output Capacitance		2	<b>4</b>	pF (max)
	Output Coding		Straight (Natural) Binary		
<b>POWER SUPPLY CHARACTERISTICS (<math>C_L = 10</math> pF)</b>					
$V_A$	Analog Supply Voltage			<b>2.7</b>	V (min)
				<b>5.25</b>	V (max)
$I_A$	Supply Current, Normal Mode (Operational, $\overline{CS}$ low)	$V_A = +5.25V$ , $f_{SAMPLE} = 500$ ksps, $f_{IN} = 40$ kHz	1.9	<b>2.4</b>	mA (max)
		$V_A = +3.6V$ , $f_{SAMPLE} = 500$ ksps, $f_{IN} = 40$ kHz	0.84	<b>1.2</b>	mA (max)
	Supply Current, Shutdown ( $\overline{CS}$ high)	$V_A = +5.25V$ , $f_{SAMPLE} = 0$ ksps	60		nA
		$V_A = +3.6V$ , $f_{SAMPLE} = 0$ ksps	38		nA
$P_D$	Power Consumption, Normal Mode (Operational, $\overline{CS}$ low)	$V_A = +5.25V$	10	<b>12.6</b>	mW (max)
		$V_A = +3.6V$	3.0	<b>4.3</b>	mW (max)
	Power Consumption, Shutdown ( $\overline{CS}$ high)	$V_A = +5.25V$	0.32		$\mu W$
		$V_A = +3.6V$	0.14		$\mu W$
<b>AC ELECTRICAL CHARACTERISTICS</b>					
$f_{SCLK}$	Maximum Clock Frequency	See <sup>(4)</sup>		<b>3.2</b>	MHz (min)
				<b>8</b>	MHz (max)
$f_S$	Sample Rate	See <sup>(4)</sup>		<b>200</b>	ksps (min)
				<b>500</b>	ksps (max)
$t_{CONV}$	Conversion Time			<b>13</b>	SCLK cycles
DC	SCLK Duty Cycle	$f_{SCLK} = 8$ MHz	50	<b>30</b>	% (min)
				<b>70</b>	% (max)
$t_{ACQ}$	Track/Hold Acquisition Time	Full-Scale Step Input		<b>3</b>	SCLK cycles
	Throughput Time	Acquisition Time + Conversion Time		<b>16</b>	SCLK cycles

(4) This is the frequency range over which the electrical performance is specified. The device is functional over a wider range which is specified under Operating Ratings.

### ADC122S051/ADC122S051Q Timing Specifications<sup>(1)</sup>

The following specifications apply for  $V_A = +2.7V$  to  $5.25V$ ,  $GND = 0V$ ,  $f_{SCLK} = 3.2$  MHz to  $8$  MHz,  $f_{SAMPLE} = 200$  kpsps to  $500$  kpsps,  $C_L = 35$  pF, **Boldface limits apply for  $T_A = T_{MIN}$  to  $T_{MAX}$** ; all other limits  $T_A = 25^\circ C$ .

Symbol	Parameter	Conditions	Typical	Limits <sup>(2)</sup>	Units	
$t_{CSU}$	Setup Time SCLK High to $\overline{CS}$ Falling Edge	See <sup>(3)</sup> $V_A = +3.0V$ $V_A = +5.0V$	-3.5 -0.5	<b>10</b>	ns (min)	
$t_{CLH}$	Hold time SCLK Low to $\overline{CS}$ Falling Edge	See <sup>(3)</sup> $V_A = +3.0V$ $V_A = +5.0V$	+4.5 +1.5	<b>10</b>	ns (min)	
$t_{EN}$	Delay from $\overline{CS}$ Until DOUT active	$V_A = +3.0V$ $V_A = +5.0V$	+4 +2	<b>30</b>	ns (max)	
$t_{ACC}$	Data Access Time after SCLK Falling Edge	$V_A = +3.0V$ $V_A = +5.0V$	+14.5 +13	<b>30</b>	ns (max)	
$t_{SU}$	Data Setup Time Prior to SCLK Rising Edge		+3	<b>10</b>	ns (min)	
$t_H$	Data Valid SCLK Hold Time		+3	<b>10</b>	ns (min)	
$t_{CH}$	SCLK High Pulse Width		$0.5 \times t_{SCLK}$	<b>0.3 x <math>t_{SCLK}</math></b>	ns (min)	
$t_{CL}$	SCLK Low Pulse Width		$0.5 \times t_{SCLK}$	<b>0.3 x <math>t_{SCLK}</math></b>	ns (min)	
$t_{DIS}$	$\overline{CS}$ Rising Edge to DOUT High-Impedance	Output Falling	$V_A = +3.0V$	1.8	<b>20</b>	ns (max)
			$V_A = +5.0V$	1.3		
		Output Rising	$V_A = +3.0V$	1.0		
			$V_A = +5.0V$	1.0		

- (1) PPAP (Production Part Approval Process) documentation of the device technology, process and qualification is available from Texas Instruments upon request.
- (2) Tested limits are specified to TI's AOQL (Average Outgoing Quality Level).
- (3) Clock may be either high or low when  $\overline{CS}$  is asserted as long as setup and hold times  $t_{CSU}$  and  $t_{CLH}$  are strictly observed.

### Timing Diagrams

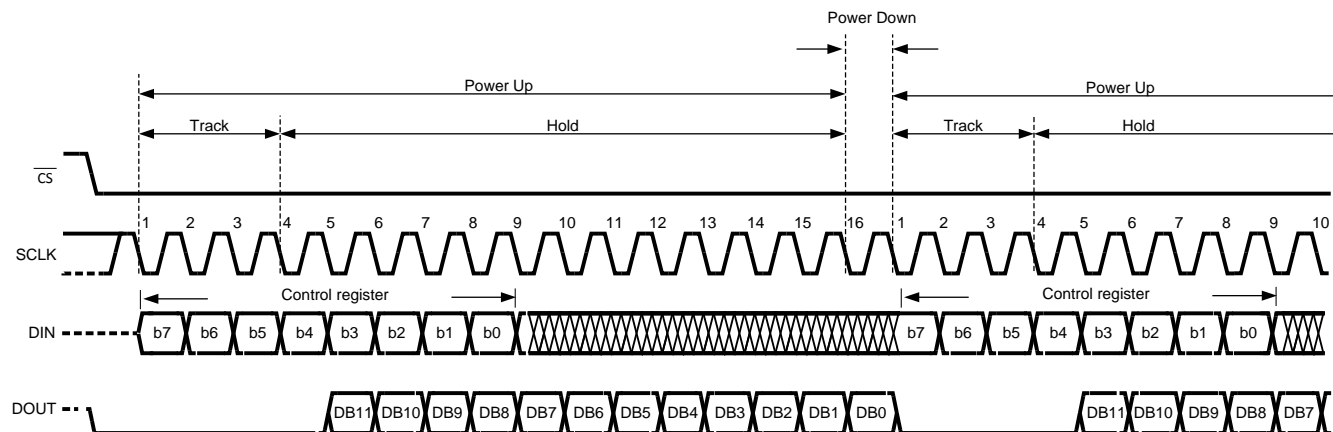

Figure 1. Operational Timing Diagram

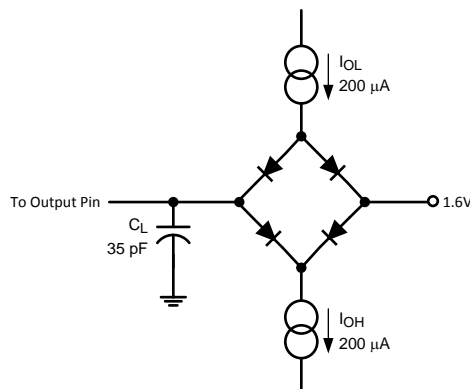

Figure 2. Timing Test Circuit

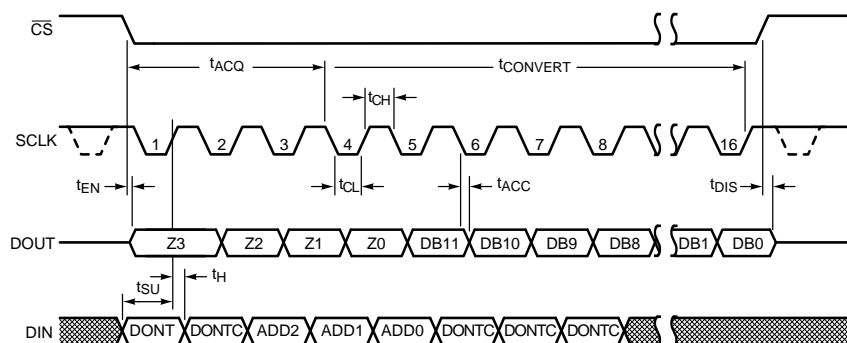

Figure 3. Serial Timing Diagram

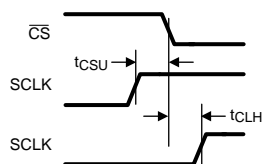

Figure 4. SCLK and  $\overline{CS}$  Timing Parameters

### Specification Definitions

**ACQUISITION TIME** is the time required to acquire the input voltage. That is, it is time required for the hold capacitor to charge up to the input voltage.

**APERTURE DELAY** is the time between the fourth falling SCLK edge of a conversion and the time when the input signal is acquired or held for conversion.

**CONVERSION TIME** is the time required, after the input voltage is acquired, for the ADC to convert the input voltage to a digital word.

**CROSSTALK** is the coupling of energy from one channel into the other channel, or the amount of signal energy from one analog input that appears at the measured analog input.

**DIFFERENTIAL NON-LINEARITY (DNL)** is the measure of the maximum deviation from the ideal step size of 1 LSB.

**DUTY CYCLE** is the ratio of the time that a repetitive digital waveform is high to the total time of one period. The specification here refers to the SCLK.

**EFFECTIVE NUMBER OF BITS (ENOB, or EFFECTIVE BITS)** is another method of specifying Signal-to-Noise and Distortion or SINAD. ENOB is defined as  $(\text{SINAD} - 1.76) / 6.02$  and says that the converter is equivalent to a perfect ADC of this (ENOB) number of bits.

**FULL POWER BANDWIDTH** is a measure of the frequency at which the reconstructed output fundamental drops 3 dB below its low frequency value for a full scale input.

**FULL SCALE ERROR (FSE)** is a measure of how far the last code transition is from the ideal  $1\frac{1}{2}$  LSB below  $V_{\text{REF}}$  and is defined as:

$$V_{\text{FSE}} = V_{\text{max}} + 1.5 \text{ LSB} - V_{\text{REF}} \quad (1)$$

where  $V_{\text{max}}$  is the voltage at which the transition to the maximum code occurs. FSE can be expressed in Volts, LSB or percent of full scale range.

**GAIN ERROR** is the deviation of the last code transition (111...110) to (111...111) from the ideal ( $V_{\text{REF}} - 1.5$  LSB), after adjusting for offset error.

**INTEGRAL NON-LINEARITY (INL)** is a measure of the deviation of each individual code from a line drawn from negative full scale ( $\frac{1}{2}$  LSB below the first code transition) through positive full scale ( $\frac{1}{2}$  LSB above the last code transition). The deviation of any given code from this straight line is measured from the center of that code value.

**INTERMODULATION DISTORTION (IMD)** is the creation of additional spectral components as a result of two sinusoidal frequencies being applied to the ADC input at the same time. It is defined as the ratio of the power in the second and third order intermodulation products to the sum of the power in both of the original frequencies. IMD is usually expressed in dB.

**MISSING CODES** are those output codes that will never appear at the ADC outputs. These codes cannot be reached with any input value. The ADC122S051/ADC122S051Q is ensured not to have any missing codes.

**OFFSET ERROR** is the deviation of the first code transition (000...000) to (000...001) from the ideal (i.e. GND + 0.5 LSB).

**SIGNAL TO NOISE RATIO (SNR)** is the ratio, expressed in dB, of the rms value of the input signal at the converter output to the rms value of the sum of all other spectral components below one-half the sampling frequency, not including d.c. or harmonics included in the THD specification.

**SIGNAL TO NOISE PLUS DISTORTION (S/N+D or SINAD)** Is the ratio, expressed in dB, of the rms value of the input signal to the rms value of all of the other spectral components below half the clock frequency, including harmonics but excluding d.c.

**SPURIOUS FREE DYNAMIC RANGE (SFDR)** is the difference, expressed in dB, between the desired signal amplitude to the amplitude of the peak spurious spectral component, where a spurious spectral component is any signal present in the output spectrum that is not present at the input and may or may not be a harmonic.



**TOTAL HARMONIC DISTORTION (THD)** is the ratio, expressed in dB or dBc, of the rms total of the first five harmonic components at the output to the rms level of the input signal frequency as seen at the output. THD is calculated as

$$\text{THD} = 20 \cdot \log_{10} \sqrt{\frac{A_{f_2}^2 + \dots + A_{f_6}^2}{A_{f_1}^2}} \quad (2)$$

where  $A_{f_1}$  is the RMS power of the input frequency at the output and  $A_{f_2}$  through  $A_{f_6}$  are the RMS power in the first 5 harmonic frequencies. Accurate THD measurement requires a spectrally pure sine wave (monotone) at the ADC input.

**THROUGHPUT TIME** is the minimum time required between the start of two successive conversion. It is the acquisition time plus the conversion and read out times. In the case of the ADC122S051/ADC122S051Q, this is 16 SCLK periods.

### Typical Performance Characteristics

$T_A = +25^\circ\text{C}$ ,  $f_{\text{SAMPLE}} = 200 \text{ kpsps}$  to  $500 \text{ kpsps}$ ,  $f_{\text{SCLK}} = 3.2 \text{ MHz}$  to  $8 \text{ MHz}$ ,  $f_{\text{IN}} = 40.2 \text{ kHz}$  unless otherwise stated.

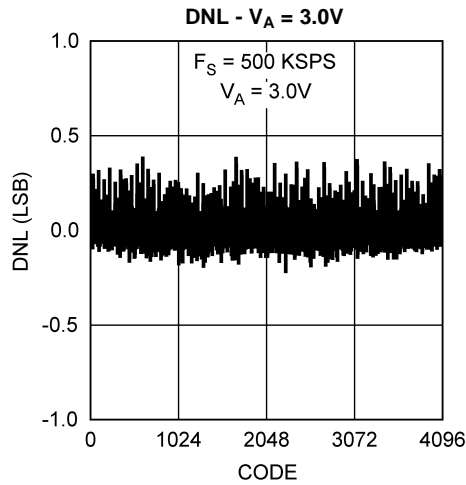

Figure 5.

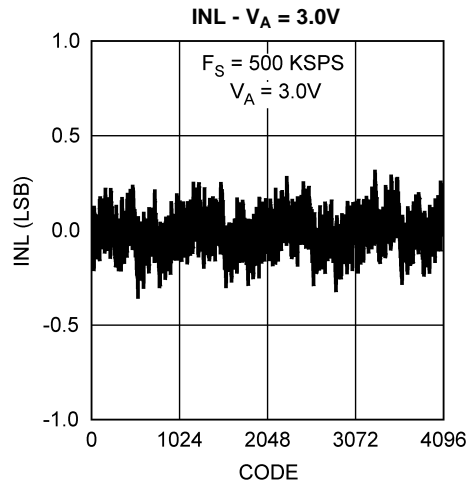

Figure 6.

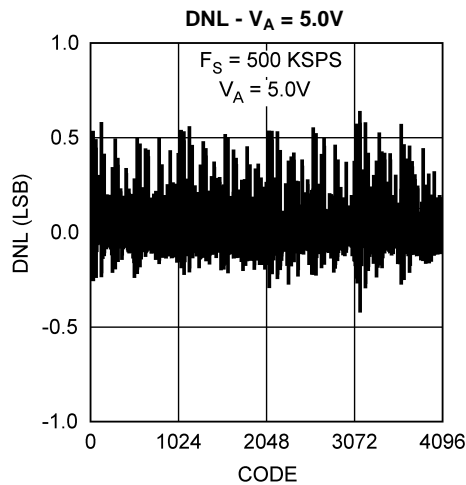

Figure 7.

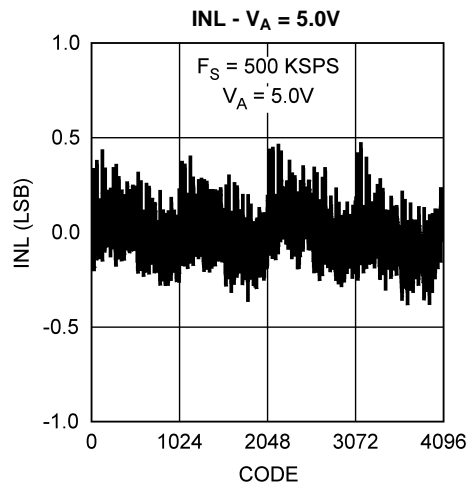

Figure 8.

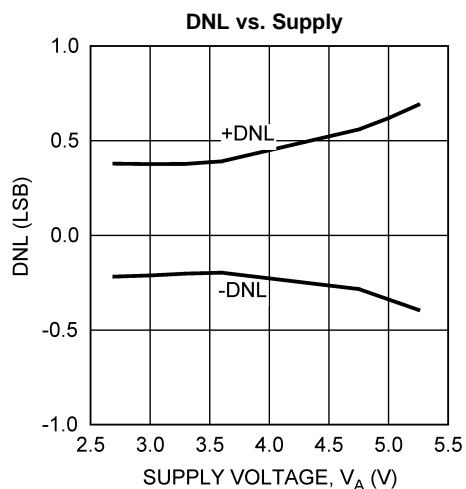

Figure 9.

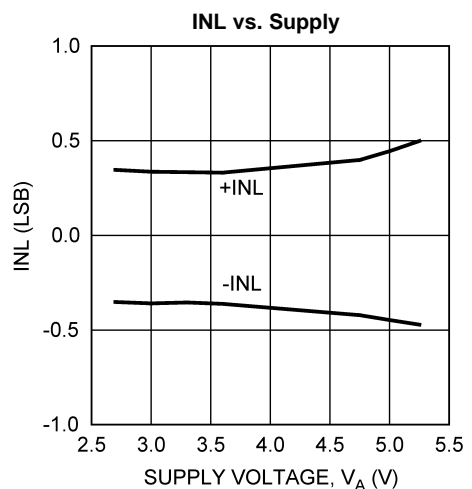

Figure 10.

Typical Performance Characteristics (continued)

$T_A = +25^\circ\text{C}$ ,  $f_{\text{SAMPLE}} = 200 \text{ kpsps to } 500 \text{ kpsps}$ ,  $f_{\text{SCLK}} = 3.2 \text{ MHz to } 8 \text{ MHz}$ ,  $f_{\text{IN}} = 40.2 \text{ kHz}$  unless otherwise stated.

DNL vs. Clock Frequency

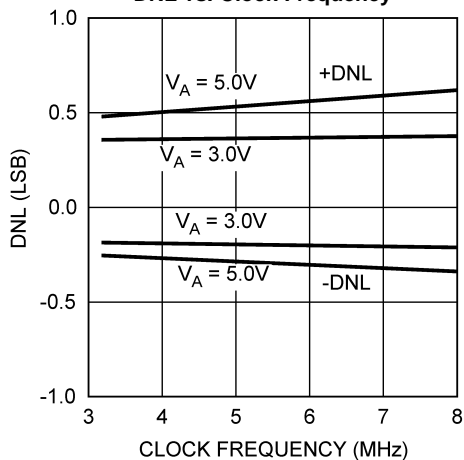

Figure 11.

INL vs. Clock Frequency

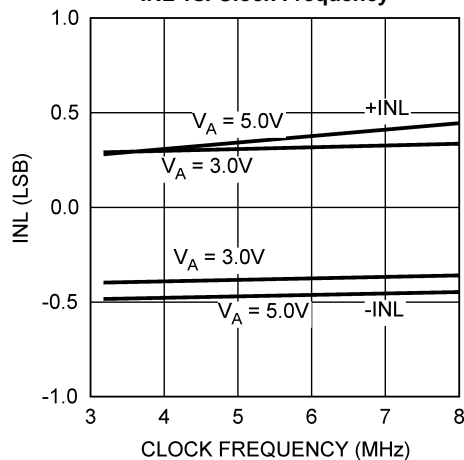

Figure 12.

DNL vs. Clock Duty Cycle

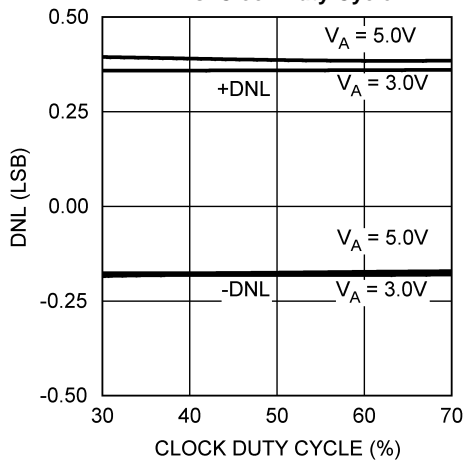

Figure 13.

INL vs. Clock Duty Cycle

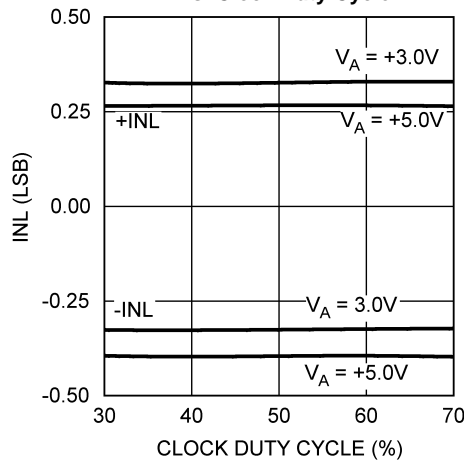

Figure 14.

DNL vs. Temperature

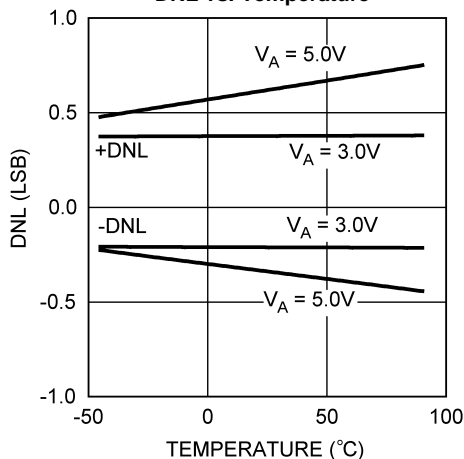

Figure 15.

INL vs. Temperature

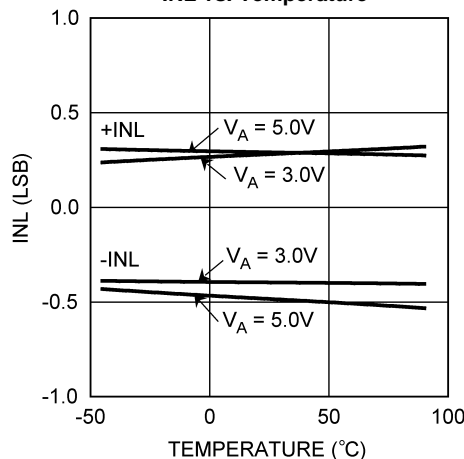

Figure 16.

**Typical Performance Characteristics (continued)**

$T_A = +25^\circ\text{C}$ ,  $f_{\text{SAMPLE}} = 200 \text{ kpsps to } 500 \text{ kpsps}$ ,  $f_{\text{SCLK}} = 3.2 \text{ MHz to } 8 \text{ MHz}$ ,  $f_{\text{IN}} = 40.2 \text{ kHz}$  unless otherwise stated.

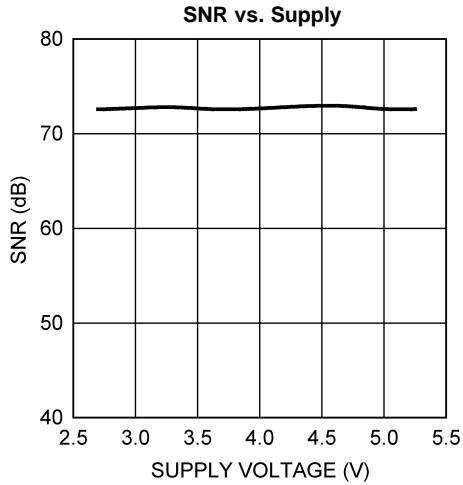

Figure 17.

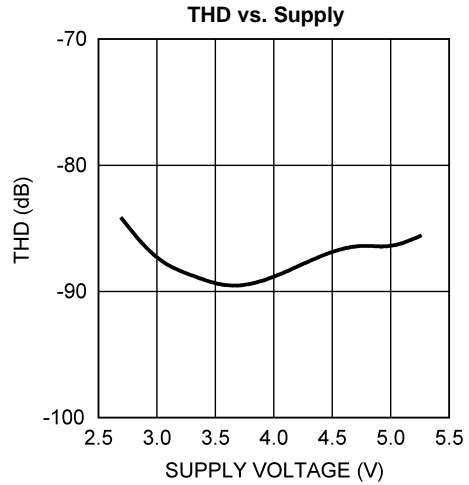

Figure 18.

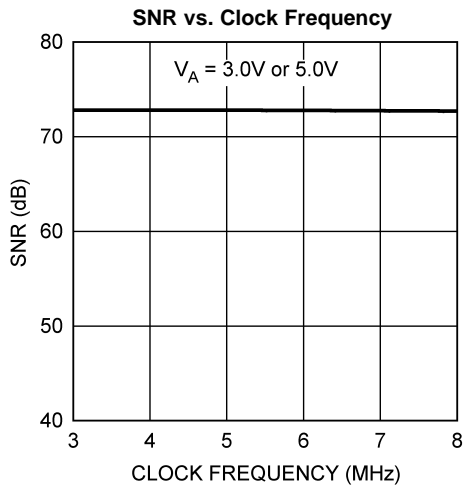

Figure 19.

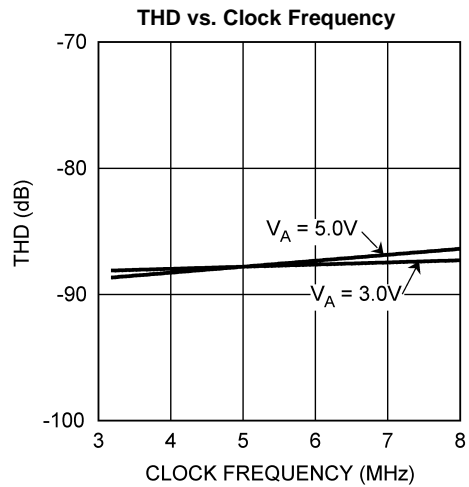

Figure 20.

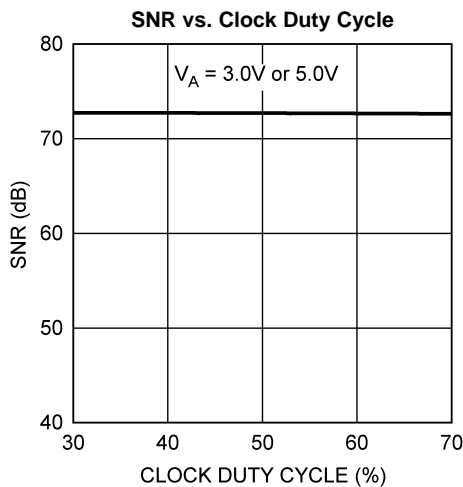

Figure 21.

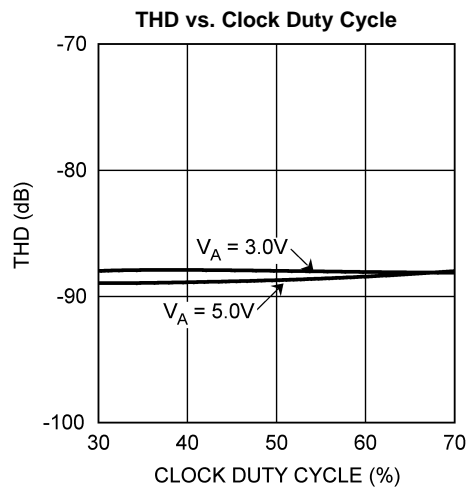

Figure 22.

**Typical Performance Characteristics (continued)**

$T_A = +25^\circ\text{C}$ ,  $f_{\text{SAMPLE}} = 200 \text{ kpsps}$  to  $500 \text{ kpsps}$ ,  $f_{\text{SCLK}} = 3.2 \text{ MHz}$  to  $8 \text{ MHz}$ ,  $f_{\text{IN}} = 40.2 \text{ kHz}$  unless otherwise stated.

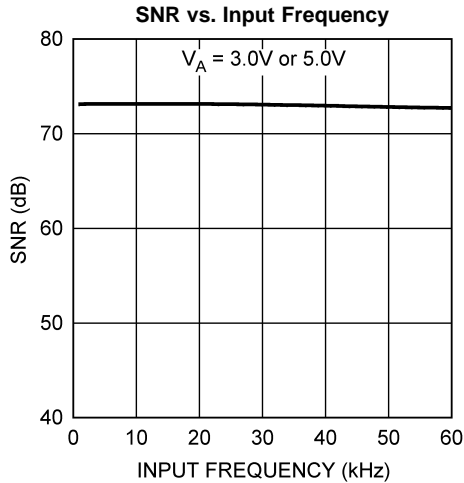

Figure 23.

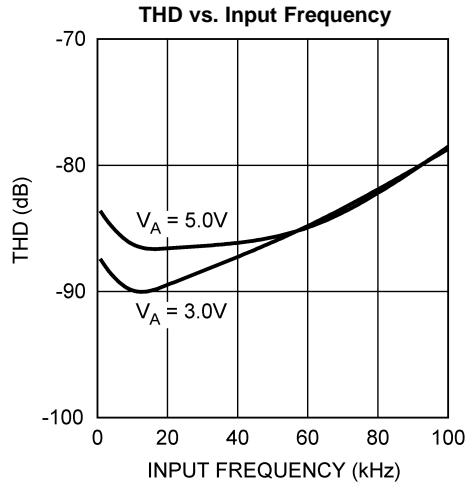

Figure 24.

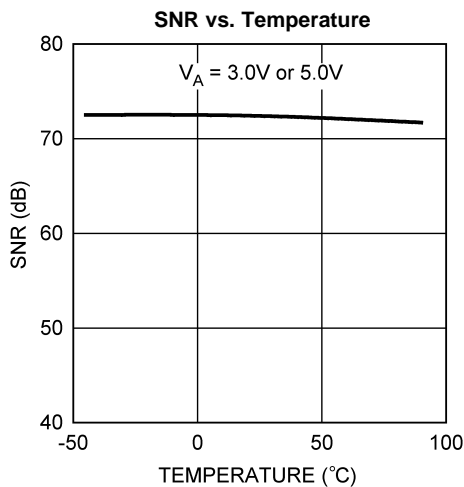

Figure 25.

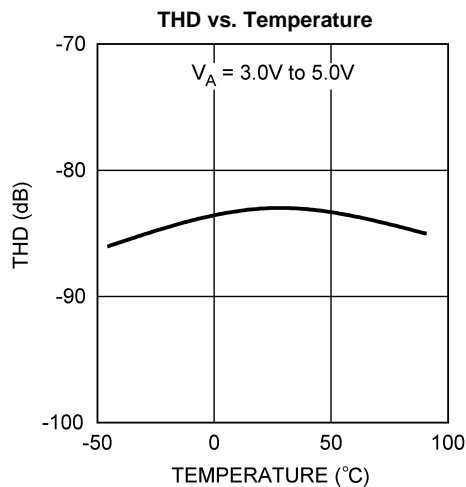

Figure 26.

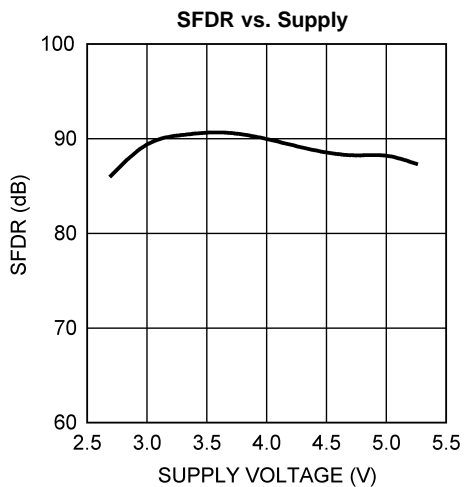

Figure 27.

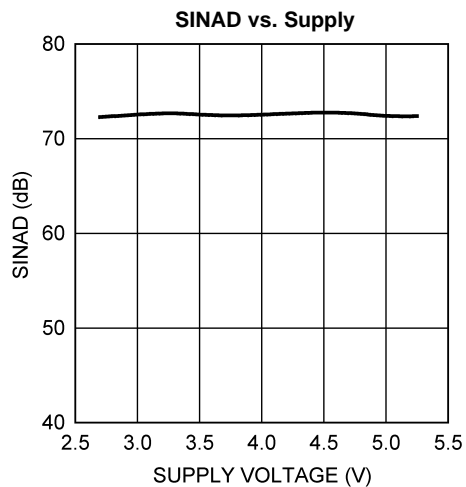

Figure 28.

**Typical Performance Characteristics (continued)**

$T_A = +25^\circ\text{C}$ ,  $f_{\text{SAMPLE}} = 200 \text{ kpsps to } 500 \text{ kpsps}$ ,  $f_{\text{SCLK}} = 3.2 \text{ MHz to } 8 \text{ MHz}$ ,  $f_{\text{IN}} = 40.2 \text{ kHz}$  unless otherwise stated.

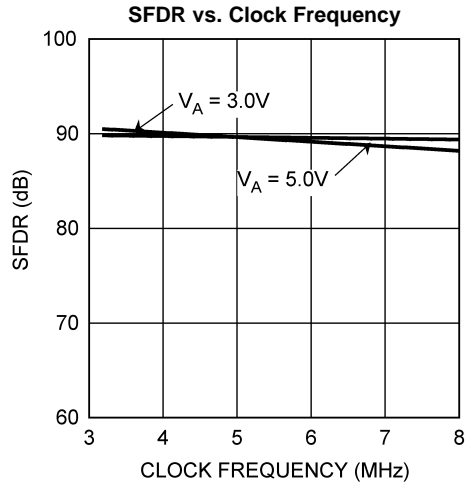

Figure 29.

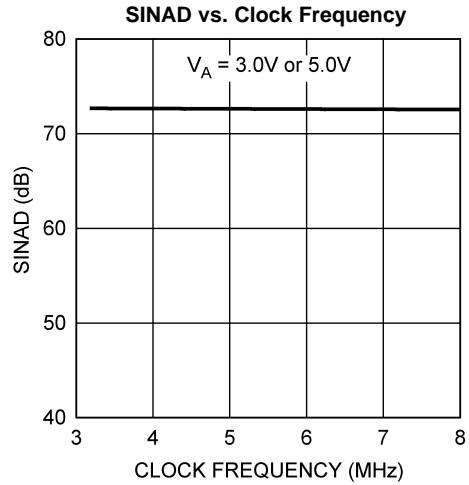

Figure 30.

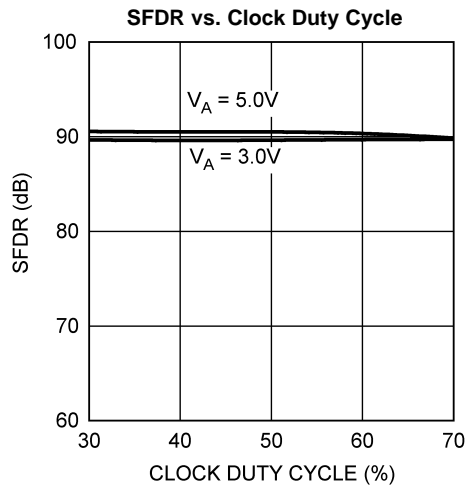

Figure 31.

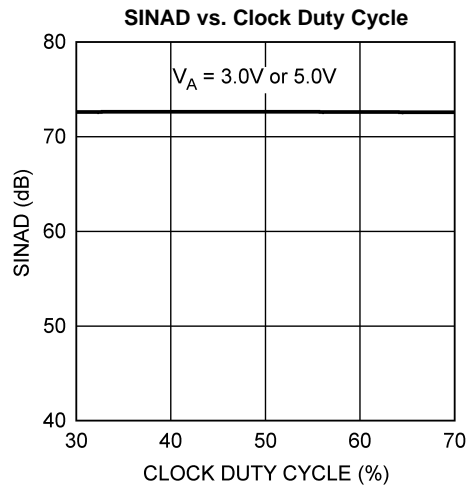

Figure 32.

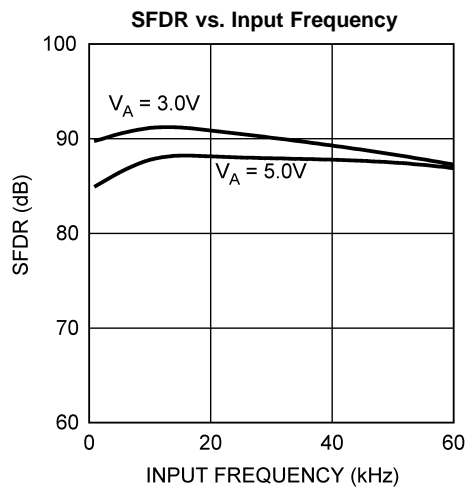

Figure 33.

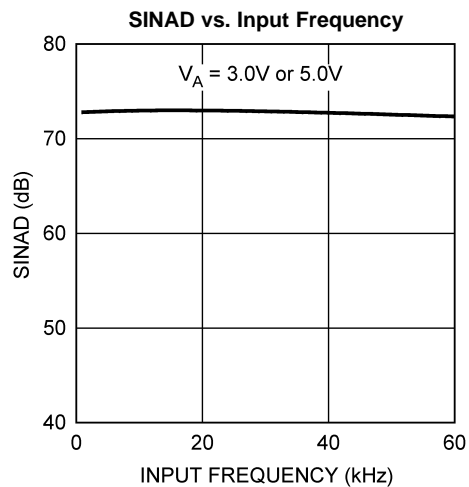

Figure 34.

Typical Performance Characteristics (continued)

$T_A = +25^\circ\text{C}$ ,  $f_{\text{SAMPLE}} = 200 \text{ kpsps to } 500 \text{ kpsps}$ ,  $f_{\text{SCLK}} = 3.2 \text{ MHz to } 8 \text{ MHz}$ ,  $f_{\text{IN}} = 40.2 \text{ kHz}$  unless otherwise stated.

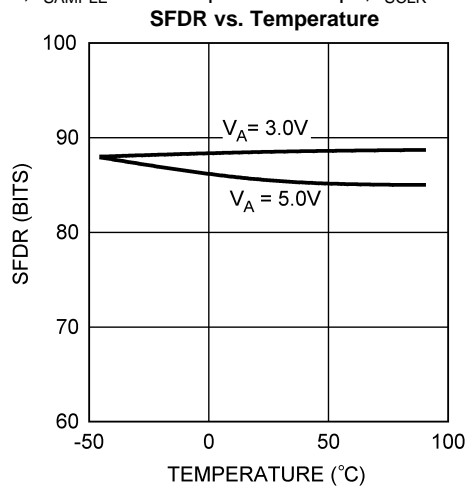

Figure 35.

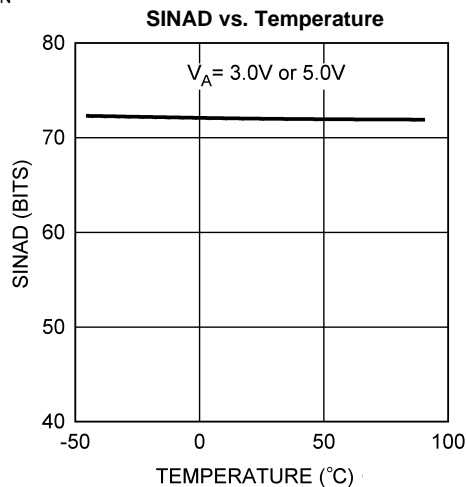

Figure 36.

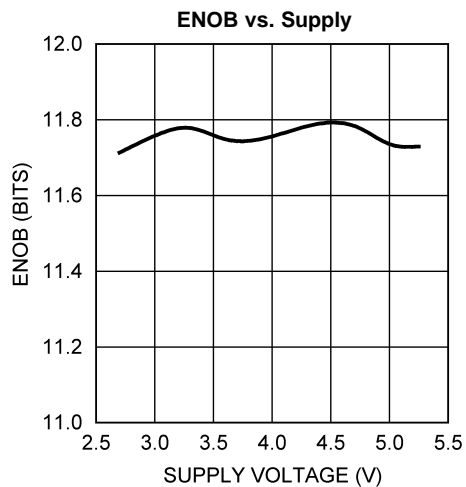

Figure 37.

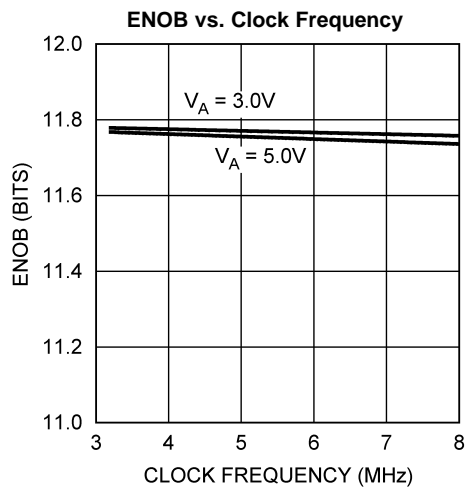

Figure 38.

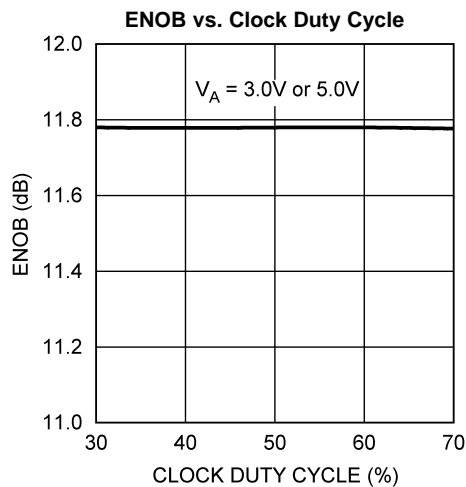

Figure 39.

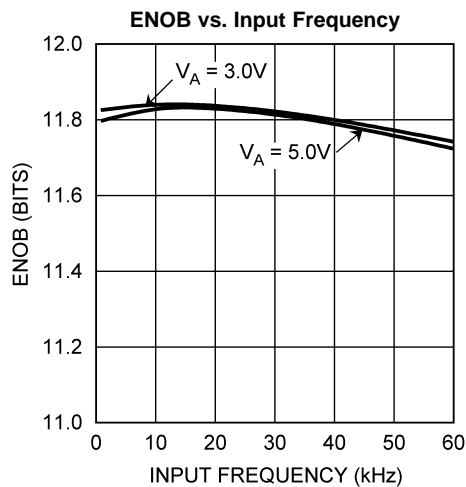

Figure 40.

**Typical Performance Characteristics (continued)**

$T_A = +25^\circ\text{C}$ ,  $f_{\text{SAMPLE}} = 200 \text{ kps}$  to  $500 \text{ kps}$ ,  $f_{\text{SCLK}} = 3.2 \text{ MHz}$  to  $8 \text{ MHz}$ ,  $f_{\text{IN}} = 40.2 \text{ kHz}$  unless otherwise stated.

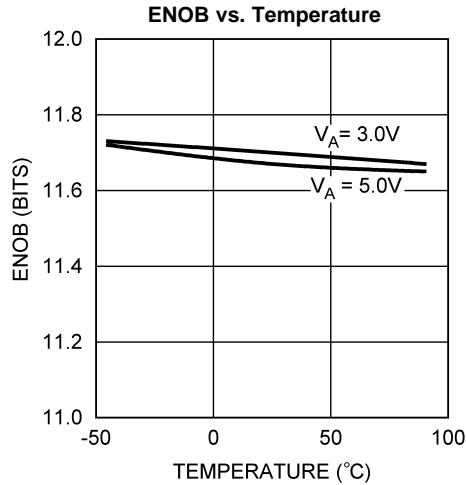

Figure 41.

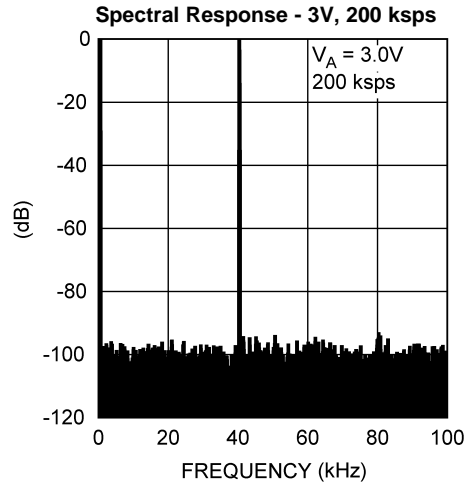

Figure 42.

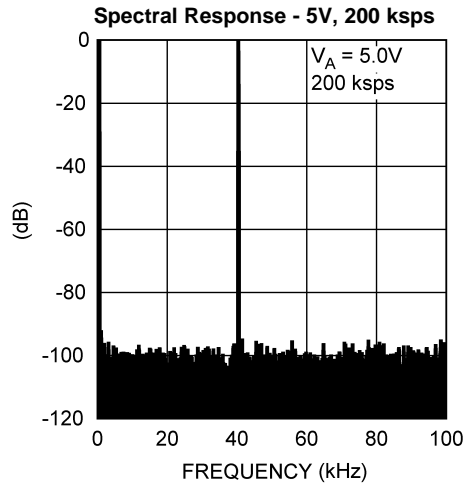

Figure 43.

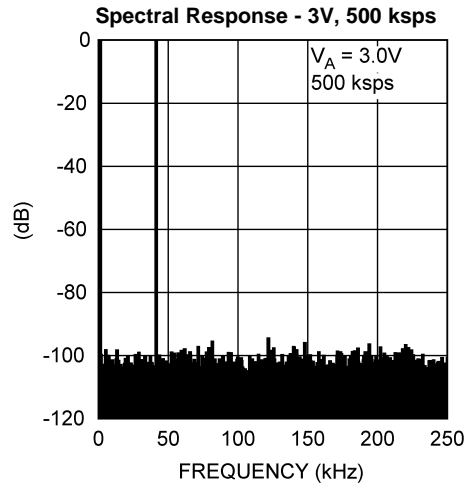

Figure 44.

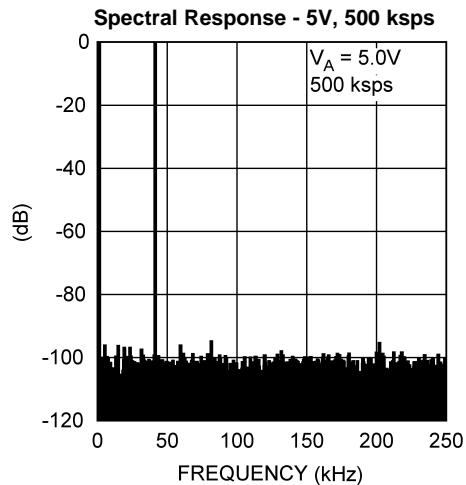

Figure 45.

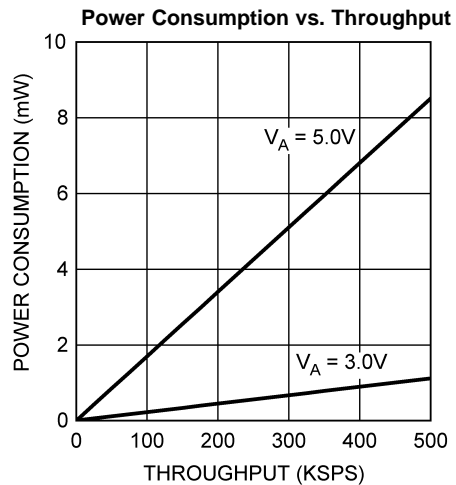

Figure 46.



## APPLICATIONS INFORMATION

### ADC122S051/ADC122S051Q OPERATION

For the rest of this document, the ADC122S051/ADC122S051Q will be referred to as the ADC122S051.

The ADC122S051 is a successive-approximation analog-to-digital converter designed around a charge-redistribution digital-to-analog converter. Simplified schematics of the ADC122S051 in both track and hold modes are shown in Figure 47 and Figure 48, respectively. In Figure 47, the ADC122S051 is in track mode: switch SW1 connects the sampling capacitor to one of two analog input channels through the multiplexer, and SW2 balances the comparator inputs. The ADC122S051 is in this state for the first three SCLK cycles after  $\overline{CS}$  is brought low.

Figure 48 shows the ADC122S051 in hold mode: switch SW1 connects the sampling capacitor to ground, maintaining the sampled voltage, and switch SW2 unbalances the comparator. The control logic then instructs the charge-redistribution DAC to add fixed amounts of charge to the sampling capacitor until the comparator is balanced. When the comparator is balanced, the digital word supplied to the DAC is the digital representation of the analog input voltage. The ADC122S051 is in this state for the fourth through sixteenth SCLK cycles after  $\overline{CS}$  is brought low.

The time when  $\overline{CS}$  is low is considered a serial frame. Each of these frames should contain an integer multiple of 16 SCLK cycles, during which time a conversion is performed and clocked out at the DOUT pin and data is clocked into the DIN pin to indicate the multiplexer address for the next conversion.

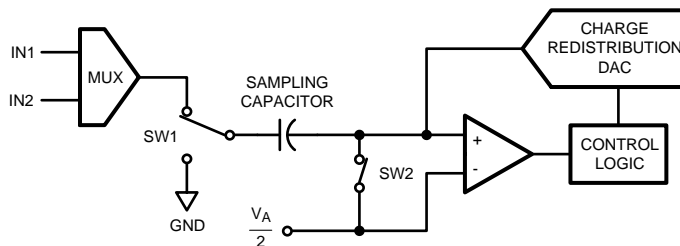

Figure 47. ADC122S051 in Track Mode

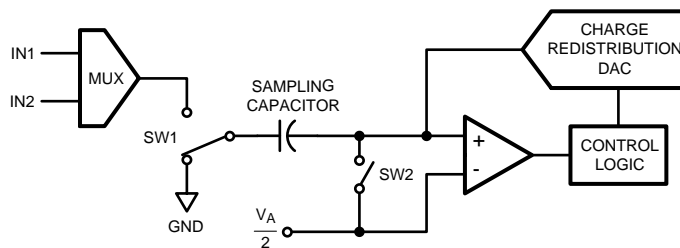

Figure 48. ADC122S051 in Hold Mode

### USING THE ADC122S051

An ADC122S051 timing diagram and a serial interface timing diagram for the ADC122S051 are shown in the [Timing Diagrams](#) section.  $\overline{CS}$  is chip select, which initiates conversions and frames the serial data transfers. SCLK (serial clock) controls both the conversion process and the timing of serial data. DOUT is the serial data output pin, where a conversion result is sent as a serial data stream, MSB first. Data to be written to the ADC122S051's Control Register is placed at DIN, the serial data input pin. New data is written to DIN with each conversion.

A serial frame is initiated on the falling edge of  $\overline{CS}$  and ends on the rising edge of  $\overline{CS}$ . Each frame must contain an integer multiple of 16 rising SCLK edges. The ADC output data (DOUT) is in a high impedance state when  $\overline{CS}$  is high and is active when  $\overline{CS}$  is low. Thus,  $\overline{CS}$  acts as an output enable. Additionally, the device goes into a power down state when  $\overline{CS}$  is high and also between continuous conversion cycles.

During the first 3 cycles of SCLK, the ADC is in the track mode, acquiring the input voltage. For the next 13 SCLK cycles the conversion is accomplished and the data is clocked out, MSB first, starting on the 5th clock. If there are more than one conversion in a frame, the ADC will re-enter the track mode on the falling edge of SCLK after the N\*16th rising edge of SCLK, and re-enter the hold/convert mode on the N\*16+4th falling edge of SCLK, where "N" is an integer.

When  $\overline{CS}$  is brought high, SCLK is internally gated off. If SCLK is stopped in the low state while  $\overline{CS}$  is high, the subsequent fall of  $\overline{CS}$  will generate a falling edge of the internal version of SCLK, putting the ADC into the track mode. This is seen by the ADC as the first falling edge of SCLK. If SCLK is stopped with SCLK high, the ADC enters the track mode on the first falling edge of SCLK after the falling edge of  $\overline{CS}$ .

During each conversion, data is clocked into the ADC at DIN on the first 8 rising edges of SCLK after the fall of  $\overline{CS}$ . For each conversion, it is necessary to clock in the data indicating the input that is selected for the conversion after the current one. See [Table 2](#), [Table 3](#), and [Table 4](#).

If  $\overline{CS}$  and SCLK go low within the times defined by  $t_{CSU}$  and  $t_{CLH}$ , the rising edge of SCLK that begins clocking data in at DIN may be one clock cycle later than expected. It is, therefore, best to strictly observe the minimum  $t_{CSU}$  and  $t_{CLH}$  times given in the Timing Specifications.

There are no power-up delays or dummy conversions required with the ADC122S051. The ADC is able to sample and convert an input to full conversion immediately following power up. The first conversion result after power-up will be that of IN1.

**Table 2. Control Register Bits**

Bit 7 (MSB)	Bit 6	Bit 5	Bit 4	Bit 3	Bit 2	Bit 1	Bit 0
DONTC	DONTC	ADD2	ADD1	ADD0	DONTC	DONTC	DONTC

**Table 3. Control Register Bit Descriptions**

Bit #:	Symbol:	Description
7 - 6, 2 - 0	DONTC	Don't care. The value of these bits do not affect the device.
3	ADD0	These three bits determine which input channel will be sampled and converted in the next track/hold cycle. The mapping between codes and channels is shown in <a href="#">Table 4</a> .
4	ADD1	
5	ADD2	

**Table 4. Input Channel Selection**

ADD2	ADD1	ADD0	Input Channel
x	0	0	IN1 (Default)
x	0	1	IN2
x	1	x	Not allowed. The output signal at the D <sub>OUT</sub> pin is indeterminate if ADD1 is high.

## ADC122S051 TRANSFER FUNCTION

The output format of the ADC122S051 is straight binary. Code transitions occur midway between successive integer LSB values. The LSB width for the ADC122S051 is  $V_A/4096$ . The ideal transfer characteristic is shown in [Figure 49](#). The transition from an output code of 0000 0000 0000 to a code of 0000 0000 0001 is at 1/2 LSB, or a voltage of  $V_A/8192$ . Other code transitions occur at steps of one LSB.

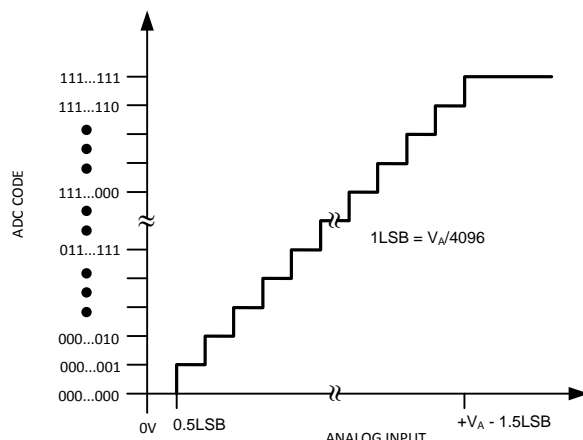

Figure 49. Ideal Transfer Characteristic

## TYPICAL APPLICATION CIRCUIT

A typical application of the ADC122S051 is shown in Figure 50. Power is provided, in this example, by the TI LP2950 low-dropout voltage regulator, available in a variety of fixed and adjustable output voltages. The power supply pin is bypassed with a capacitor network located close to the ADC122S051. Because the reference for the ADC122S051 is the supply voltage, any noise on the supply will degrade device noise performance. To keep noise off the supply, use a dedicated linear regulator for this device, or provide sufficient decoupling from other circuitry to keep noise off the ADC122S051 supply pin. Because of the ADC122S051's low power requirements, it is also possible to use a precision reference as a power supply to maximize performance. The four-wire interface is shown connected to a microprocessor or DSP.

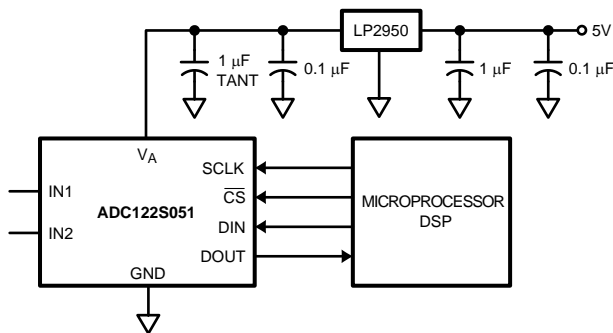
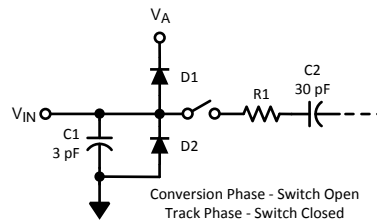

Figure 50. Typical Application Circuit

## ANALOG INPUTS

An equivalent circuit for one of the ADC122S051's input channels is shown in Figure 51. Diodes D1 and D2 provide ESD protection for the analog inputs. At no time should any input go beyond ( $V_A + 300$  mV) or ( $GND - 300$  mV), as these ESD diodes will begin conducting, which could result in erratic operation. For this reason, these ESD diodes should NOT be used to clamp the input signal.

The capacitor C1 in Figure 51 has a typical value of 3 pF, and is mainly the package pin capacitance. Resistor R1 is the on resistance of the multiplexer and track / hold switch, and is typically 500 ohms. Capacitor C2 is the ADC122S051 sampling capacitor and is typically 30 pF. The ADC122S051 will deliver best performance when driven by a low-impedance source to eliminate distortion caused by the charging of the sampling capacitance. This is especially important when using the ADC122S051 to sample AC signals. Also important when sampling dynamic signals is a band-pass or low-pass filter to reduce harmonics and noise, improving dynamic performance.



**Figure 51. Equivalent Input Circuit**

## DIGITAL INPUTS AND OUTPUTS

The ADC122S051's digital output DOUT is limited by, and cannot exceed, the supply voltage,  $V_A$ . The digital input pins are not prone to latch-up and, although not recommended, SCLK,  $\overline{CS}$  and DIN may be asserted before  $V_A$  without any latch-up risk.

## POWER SUPPLY CONSIDERATIONS

The ADC122S051 is fully powered-up whenever  $\overline{CS}$  is low, and fully powered-down whenever  $\overline{CS}$  is high, with one exception: the ADC122S051 automatically enters power-down mode between the 16th falling edge of a conversion and the 1st falling edge of the subsequent conversion (see Timing Diagrams).

The ADC122S051 can perform multiple conversions back to back; each conversion requires 16 SCLK cycles. The ADC122S051 will perform conversions continuously as long as  $\overline{CS}$  is held low.

The user may trade off throughput for power consumption by simply performing fewer conversions per unit time. The Power Consumption vs. Sample Rate curve in the [Typical Performance Characteristics](#) section shows the typical power consumption of the ADC122S051 versus throughput. To calculate the power consumption, simply multiply the fraction of time spent in the normal mode by the normal mode power consumption, and add the fraction of time spent in shutdown mode multiplied by the shutdown mode power dissipation.

### Power Management

When the ADC122S051 is operated continuously in normal mode, the maximum throughput is  $f_{SCLK}/16$ . Throughput may be traded for power consumption by running  $f_{SCLK}$  at its maximum 8 MHz and performing fewer conversions per unit time, putting the ADC122S051 into shutdown mode between conversions. A plot of typical power consumption versus throughput is shown in the [Typical Performance Characteristics](#) section. To calculate the power consumption for a given throughput, multiply the fraction of time spent in the normal mode by the normal mode power consumption and add the fraction of time spent in shutdown mode multiplied by the shutdown mode power consumption. Generally, the user will put the part into normal mode and then put the part back into shutdown mode. Note that the curve of power consumption vs. throughput is nearly linear. This is because the power consumption in the shutdown mode is so small that it can be ignored for all practical purposes.

### Power Supply Noise Considerations

The charging of any output load capacitance requires current from the power supply,  $V_A$ . The current pulses required from the supply to charge the output capacitance will cause voltage variations on the supply. If these variations are large enough, they could degrade SNR and SINAD performance of the ADC. Furthermore, discharging the output capacitance when the digital output goes from a logic high to a logic low will dump current into the die substrate, which is resistive. Load discharge currents will cause "ground bounce" noise in the substrate that will degrade noise performance if that current is large enough. The larger is the output capacitance, the more current flows through the die substrate and the greater is the noise coupled into the analog channel, degrading noise performance.

To keep noise out of the power supply, keep the output load capacitance as small as practical. If the load capacitance is greater than 35 pF, use a 100  $\Omega$  series resistor at the ADC output, located as close to the ADC output pin as practical. This will limit the charge and discharge current of the output capacitance and improve noise performance.

---

**REVISION HISTORY**

<b>Changes from Revision D (March 2013) to Revision E</b>	<b>Page</b>
• Changed layout of National Data Sheet to TI format .....	<a href="#">20</a>

---

**PACKAGING INFORMATION**

Orderable Device	Status (1)	Package Type	Package Drawing	Pins	Package Qty	Eco Plan (2)	Lead/Ball Finish (6)	MSL Peak Temp (3)	Op Temp (°C)	Device Marking (4/5)	Samples
ADC122S051CIMM/NOPB	ACTIVE	VSSOP	DGK	8	1000	Green (RoHS & no Sb/Br)	CU SN	Level-1-260C-UNLIM	-40 to 85	X06C	<a href="#">Samples</a>
ADC122S051CIMMX/NOPB	ACTIVE	VSSOP	DGK	8	3500	Green (RoHS & no Sb/Br)	CU SN	Level-1-260C-UNLIM	-40 to 85	X06C	<a href="#">Samples</a>
ADC122S051QIMM/NOPB	ACTIVE	VSSOP	DGK	8	1000	Green (RoHS & no Sb/Br)	CU SN	Level-1-260C-UNLIM	-40 to 85	X06Q	<a href="#">Samples</a>
ADC122S051QIMMX/NOPB	ACTIVE	VSSOP	DGK	8	3500	Green (RoHS & no Sb/Br)	CU SN	Level-1-260C-UNLIM	-40 to 85	X06Q	<a href="#">Samples</a>

(1) The marketing status values are defined as follows:

**ACTIVE:** Product device recommended for new designs.

**LIFEBUY:** TI has announced that the device will be discontinued, and a lifetime-buy period is in effect.

**NRND:** Not recommended for new designs. Device is in production to support existing customers, but TI does not recommend using this part in a new design.

**PREVIEW:** Device has been announced but is not in production. Samples may or may not be available.

**OBSELETE:** TI has discontinued the production of the device.

(2) Eco Plan - The planned eco-friendly classification: Pb-Free (RoHS), Pb-Free (RoHS Exempt), or Green (RoHS & no Sb/Br) - please check <http://www.ti.com/productcontent> for the latest availability information and additional product content details.

**TBD:** The Pb-Free/Green conversion plan has not been defined.

**Pb-Free (RoHS):** TI's terms "Lead-Free" or "Pb-Free" mean semiconductor products that are compatible with the current RoHS requirements for all 6 substances, including the requirement that lead not exceed 0.1% by weight in homogeneous materials. Where designed to be soldered at high temperatures, TI Pb-Free products are suitable for use in specified lead-free processes.

**Pb-Free (RoHS Exempt):** This component has a RoHS exemption for either 1) lead-based flip-chip solder bumps used between the die and package, or 2) lead-based die adhesive used between the die and leadframe. The component is otherwise considered Pb-Free (RoHS compatible) as defined above.

**Green (RoHS & no Sb/Br):** TI defines "Green" to mean Pb-Free (RoHS compatible), and free of Bromine (Br) and Antimony (Sb) based flame retardants (Br or Sb do not exceed 0.1% by weight in homogeneous material)

(3) MSL, Peak Temp. - The Moisture Sensitivity Level rating according to the JEDEC industry standard classifications, and peak solder temperature.

(4) There may be additional marking, which relates to the logo, the lot trace code information, or the environmental category on the device.

(5) Multiple Device Markings will be inside parentheses. Only one Device Marking contained in parentheses and separated by a "~" will appear on a device. If a line is indented then it is a continuation of the previous line and the two combined represent the entire Device Marking for that device.

(6) Lead/Ball Finish - Orderable Devices may have multiple material finish options. Finish options are separated by a vertical ruled line. Lead/Ball Finish values may wrap to two lines if the finish value exceeds the maximum column width.

**Important Information and Disclaimer:** The information provided on this page represents TI's knowledge and belief as of the date that it is provided. TI bases its knowledge and belief on information provided by third parties, and makes no representation or warranty as to the accuracy of such information. Efforts are underway to better integrate information from third parties. TI has taken and continues to take reasonable steps to provide representative and accurate information but may not have conducted destructive testing or chemical analysis on incoming materials and chemicals. TI and TI suppliers consider certain information to be proprietary, and thus CAS numbers and other limited information may not be available for release.

In no event shall TI's liability arising out of such information exceed the total purchase price of the TI part(s) at issue in this document sold by TI to Customer on an annual basis.

**TAPE AND REEL INFORMATION**

**QUADRANT ASSIGNMENTS FOR PIN 1 ORIENTATION IN TAPE**

\*All dimensions are nominal

Device	Package Type	Package Drawing	Pins	SPQ	Reel Diameter (mm)	Reel Width W1 (mm)	A0 (mm)	B0 (mm)	K0 (mm)	P1 (mm)	W (mm)	Pin1 Quadrant
ADC122S051C1MM/NOPB	VSSOP	DGK	8	1000	178.0	12.4	5.3	3.4	1.4	8.0	12.0	Q1
ADC122S051C1MMX/NOPB	VSSOP	DGK	8	3500	330.0	12.4	5.3	3.4	1.4	8.0	12.0	Q1
ADC122S051Q1MM/NOPB	VSSOP	DGK	8	1000	178.0	12.4	5.3	3.4	1.4	8.0	12.0	Q1
ADC122S051Q1MMX/NOPB	VSSOP	DGK	8	3500	330.0	12.4	5.3	3.4	1.4	8.0	12.0	Q1



## TAPE AND REEL BOX DIMENSIONS



\*All dimensions are nominal

Device	Package Type	Package Drawing	Pins	SPQ	Length (mm)	Width (mm)	Height (mm)
ADC122S051CIMM/NOPB	VSSOP	DGK	8	1000	210.0	185.0	35.0
ADC122S051CIMMX/NOP B	VSSOP	DGK	8	3500	367.0	367.0	35.0
ADC122S051QIMM/NOPB	VSSOP	DGK	8	1000	210.0	185.0	35.0
ADC122S051QIMMX/NOP B	VSSOP	DGK	8	3500	367.0	367.0	35.0

DGK (S-PDSO-G8)

PLASTIC SMALL-OUTLINE PACKAGE

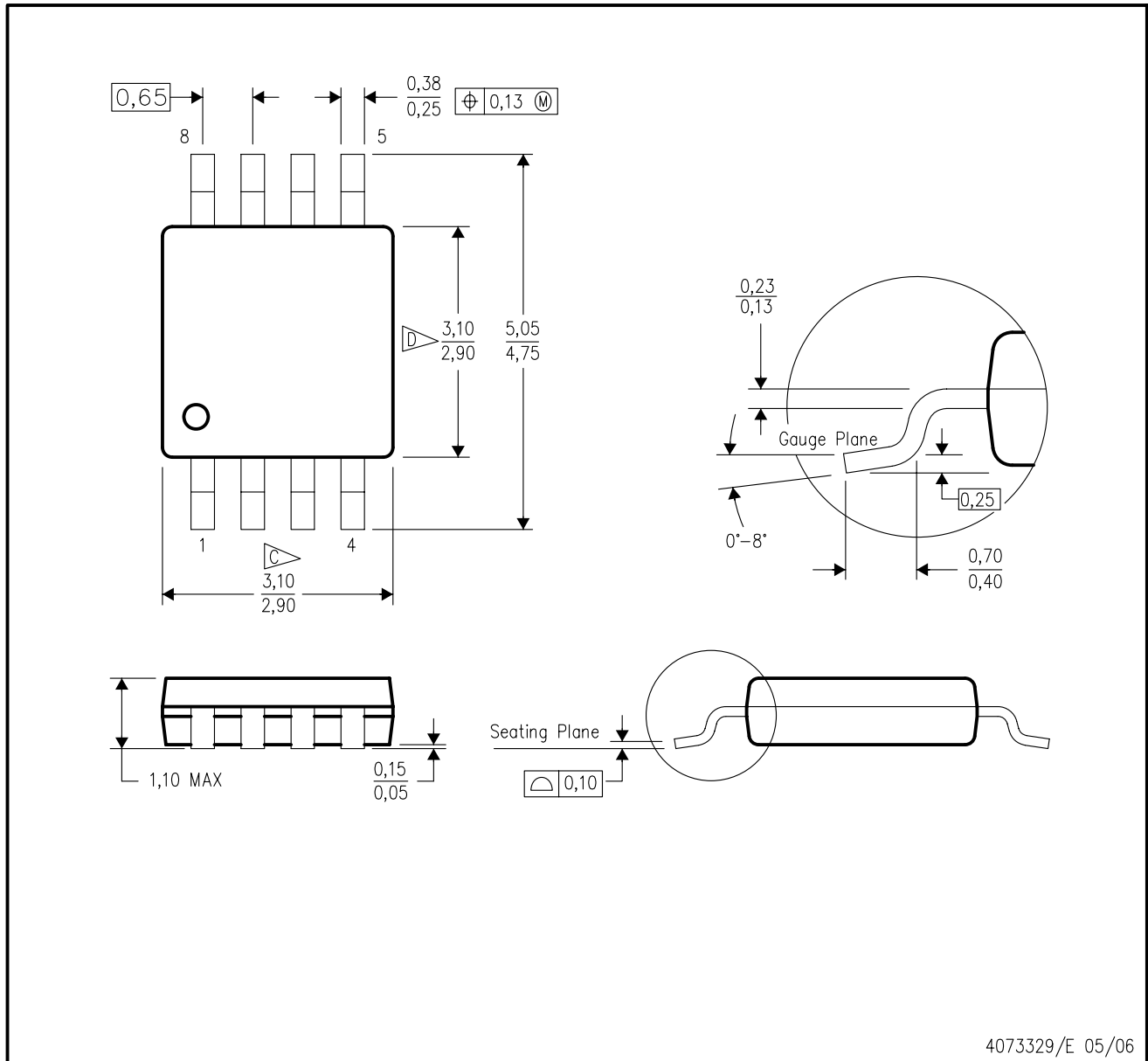

- NOTES:
- A. All linear dimensions are in millimeters.
  - B. This drawing is subject to change without notice.
  - C. Body length does not include mold flash, protrusions, or gate burrs. Mold flash, protrusions, or gate burrs shall not exceed 0.15 per end.
  - D. Body width does not include interlead flash. Interlead flash shall not exceed 0.50 per side.
  - E. Falls within JEDEC MO-187 variation AA, except interlead flash.



- NOTES:
- A. All linear dimensions are in millimeters.
  - B. This drawing is subject to change without notice.
  - C. Publication IPC-7351 is recommended for alternate designs.
  - D. Laser cutting apertures with trapezoidal walls and also rounding corners will offer better paste release. Customers should contact their board assembly site for stencil design recommendations. Refer to IPC-7525 for other stencil recommendations.
  - E. Customers should contact their board fabrication site for solder mask tolerances between and around signal pads.

## IMPORTANT NOTICE

Texas Instruments Incorporated and its subsidiaries (TI) reserve the right to make corrections, enhancements, improvements and other changes to its semiconductor products and services per JESD46, latest issue, and to discontinue any product or service per JESD48, latest issue. Buyers should obtain the latest relevant information before placing orders and should verify that such information is current and complete. All semiconductor products (also referred to herein as "components") are sold subject to TI's terms and conditions of sale supplied at the time of order acknowledgment.

TI warrants performance of its components to the specifications applicable at the time of sale, in accordance with the warranty in TI's terms and conditions of sale of semiconductor products. Testing and other quality control techniques are used to the extent TI deems necessary to support this warranty. Except where mandated by applicable law, testing of all parameters of each component is not necessarily performed.

TI assumes no liability for applications assistance or the design of Buyers' products. Buyers are responsible for their products and applications using TI components. To minimize the risks associated with Buyers' products and applications, Buyers should provide adequate design and operating safeguards.

TI does not warrant or represent that any license, either express or implied, is granted under any patent right, copyright, mask work right, or other intellectual property right relating to any combination, machine, or process in which TI components or services are used. Information published by TI regarding third-party products or services does not constitute a license to use such products or services or a warranty or endorsement thereof. Use of such information may require a license from a third party under the patents or other intellectual property of the third party, or a license from TI under the patents or other intellectual property of TI.

Reproduction of significant portions of TI information in TI data books or data sheets is permissible only if reproduction is without alteration and is accompanied by all associated warranties, conditions, limitations, and notices. TI is not responsible or liable for such altered documentation. Information of third parties may be subject to additional restrictions.

Resale of TI components or services with statements different from or beyond the parameters stated by TI for that component or service voids all express and any implied warranties for the associated TI component or service and is an unfair and deceptive business practice. TI is not responsible or liable for any such statements.

Buyer acknowledges and agrees that it is solely responsible for compliance with all legal, regulatory and safety-related requirements concerning its products, and any use of TI components in its applications, notwithstanding any applications-related information or support that may be provided by TI. Buyer represents and agrees that it has all the necessary expertise to create and implement safeguards which anticipate dangerous consequences of failures, monitor failures and their consequences, lessen the likelihood of failures that might cause harm and take appropriate remedial actions. Buyer will fully indemnify TI and its representatives against any damages arising out of the use of any TI components in safety-critical applications.

In some cases, TI components may be promoted specifically to facilitate safety-related applications. With such components, TI's goal is to help enable customers to design and create their own end-product solutions that meet applicable functional safety standards and requirements. Nonetheless, such components are subject to these terms.

No TI components are authorized for use in FDA Class III (or similar life-critical medical equipment) unless authorized officers of the parties have executed a special agreement specifically governing such use.

Only those TI components which TI has specifically designated as military grade or "enhanced plastic" are designed and intended for use in military/aerospace applications or environments. Buyer acknowledges and agrees that any military or aerospace use of TI components which have **not** been so designated is solely at the Buyer's risk, and that Buyer is solely responsible for compliance with all legal and regulatory requirements in connection with such use.

TI has specifically designated certain components as meeting ISO/TS16949 requirements, mainly for automotive use. In any case of use of non-designated products, TI will not be responsible for any failure to meet ISO/TS16949.

### Products

Audio	<a href="http://www.ti.com/audio">www.ti.com/audio</a>
Amplifiers	<a href="http://amplifier.ti.com">amplifier.ti.com</a>
Data Converters	<a href="http://dataconverter.ti.com">dataconverter.ti.com</a>
DLP® Products	<a href="http://www.dlp.com">www.dlp.com</a>
DSP	<a href="http://dsp.ti.com">dsp.ti.com</a>
Clocks and Timers	<a href="http://www.ti.com/clocks">www.ti.com/clocks</a>
Interface	<a href="http://interface.ti.com">interface.ti.com</a>
Logic	<a href="http://logic.ti.com">logic.ti.com</a>
Power Mgmt	<a href="http://power.ti.com">power.ti.com</a>
Microcontrollers	<a href="http://microcontroller.ti.com">microcontroller.ti.com</a>
RFID	<a href="http://www.ti-rfid.com">www.ti-rfid.com</a>
OMAP Applications Processors	<a href="http://www.ti.com/omap">www.ti.com/omap</a>
Wireless Connectivity	<a href="http://www.ti.com/wirelessconnectivity">www.ti.com/wirelessconnectivity</a>

### Applications

Automotive and Transportation	<a href="http://www.ti.com/automotive">www.ti.com/automotive</a>
Communications and Telecom	<a href="http://www.ti.com/communications">www.ti.com/communications</a>
Computers and Peripherals	<a href="http://www.ti.com/computers">www.ti.com/computers</a>
Consumer Electronics	<a href="http://www.ti.com/consumer-apps">www.ti.com/consumer-apps</a>
Energy and Lighting	<a href="http://www.ti.com/energy">www.ti.com/energy</a>
Industrial	<a href="http://www.ti.com/industrial">www.ti.com/industrial</a>
Medical	<a href="http://www.ti.com/medical">www.ti.com/medical</a>
Security	<a href="http://www.ti.com/security">www.ti.com/security</a>
Space, Avionics and Defense	<a href="http://www.ti.com/space-avionics-defense">www.ti.com/space-avionics-defense</a>
Video and Imaging	<a href="http://www.ti.com/video">www.ti.com/video</a>

### TI E2E Community

[e2e.ti.com](http://e2e.ti.com)