

## GaAs MMIC VOLTAGE-VARIABLE ATTENUATOR, 5 - 26.5 GHz

### Typical Applications

The HMC712ALP3CE is ideal for:

- Point-to-Point Radio
- VSAT Radio
- Test Instrumentation
- Microwave Sensors
- Military, ECM & Radar

### Functional Diagram

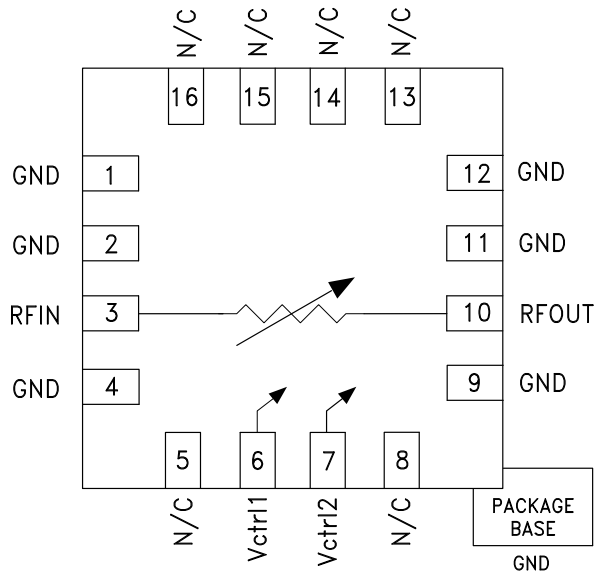

### Features

- Wide Bandwidth: 5 - 26.5 GHz
- Excellent Linearity: +28 dBm Input P1dB
- Wide Attenuation Range: 28 dB
- Absorptive Topology
- Singe or Dual Control Operation
- 16 Lead 3x3mm SMT Package: 9mm<sup>2</sup>

### General Description

The HMC712ALP3CE is an absorptive Voltage Variable Attenuator (VVA) which operates from 5 - 26.5 GHz and is ideal in designs where an analog DC control signal must be used to control RF signal levels over a 28 dB amplitude range. It features two shunt-type attenuators which are controlled by two analog voltages, Vctrl1 and Vctrl2. Optimum linearity performance of the attenuator is achieved by first varying Vctrl1 of the 1st attenuation stage from -5V to 0V with Vctrl2 fixed at -5V. The control voltage of the 2nd attenuation stage, Vctrl2, should then be varied from -5V to 0V, with Vctrl1 fixed at 0V. The HMC712ALP3CE is housed in a RoHS compliant 3x3 mm QFN leadless package

Furthermore, if the Vctrl1 and Vctrl2 pins are connected together it is possible to achieve the full analog attenuation range with only a small degradation in input IP3 performance. Applications include AGC circuits and temperature compensation of multiple gain stages in microwave point-to-point and VSAT radios.

### Electrical Specifications, $T_A = +25^\circ\text{C}$ , 50 Ohm system

Parameter	Min.	Typ.	Max.	Units
Insertion Loss	5 - 10 GHz	2.3	3.5	dB
	10 - 15 GHz	3	4	dB
	15 - 26.5 GHz	4.2	5.7	dB
Attenuation Range	5 - 10 GHz	19	27	dB
	10 - 15 GHz	21	32	dB
	15 - 26.5 GHz	23	37	dB
Input Return Loss		12		dB
Output Return Loss		10		dB
Input Power for 1 dB Compression (any attenuation)		28		dBm
Input Third Order Intercept (Two-tone Input Power = 10 dBm Each Tone)		32		dBm

# HMC712A\* PRODUCT PAGE QUICK LINKS

Last Content Update: 06/09/2017

---

## COMPARABLE PARTS

View a parametric search of comparable parts.

## EVALUATION KITS

- HMC712A Evaluation Board

## DOCUMENTATION

### Data Sheet

- HMC712A: GaAs MMIC Voltage-Variable Attenuator, 5 - 26.5 GHz Preliminary Data Sheet

## TOOLS AND SIMULATIONS

- HMC712A S-Parameters

## DESIGN RESOURCES

- HMC712A Material Declaration
- PCN-PDN Information
- Quality And Reliability
- Symbols and Footprints

## DISCUSSIONS

View all HMC712A EngineerZone Discussions.

## SAMPLE AND BUY

Visit the product page to see pricing options.

## TECHNICAL SUPPORT

Submit a technical question or find your regional support number.

## DOCUMENT FEEDBACK

Submit feedback for this data sheet.

---

**GaAs MMIC VOLTAGE-VARIABLE ATTENUATOR, 5 - 26.5 GHz**

**Attenuation vs. Frequency over Vctrl**  
Vctrl1 = Variable, Vctrl2 = -5V

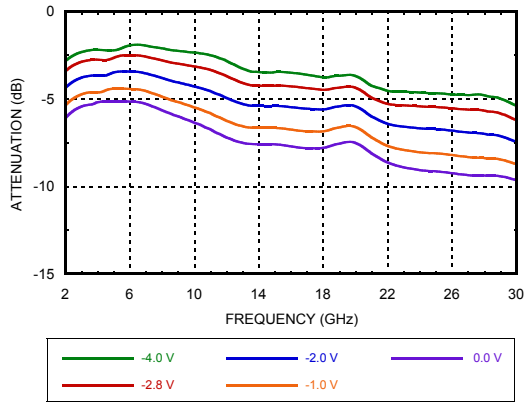

**Attenuation vs. Frequency over Vctrl**  
Vctrl1 = 0V, Vctrl2 = Variable

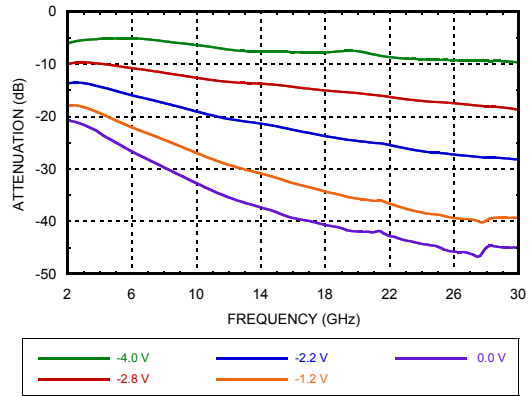

**Attenuation vs. Vctrl1**  
Over Temperature @ 10 GHz, Vctrl2 = -5V

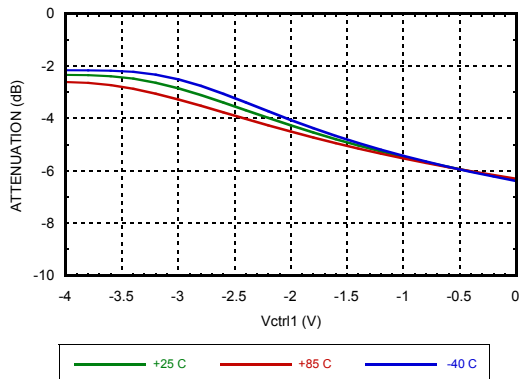

**Attenuation vs. Vctrl2**  
Over Temperature @ 10 GHz, Vctrl1 = 0V

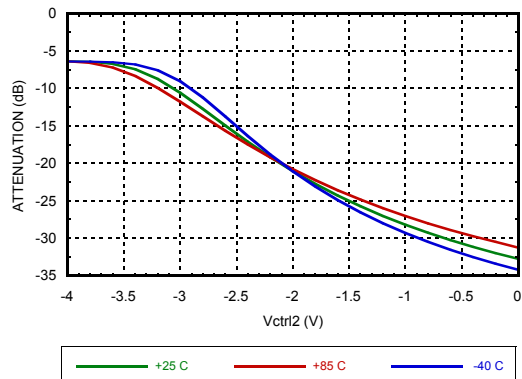

**Attenuation vs. Pin @ 10 GHz**  
Vctrl1 = Variable, Vctrl2 = -5V

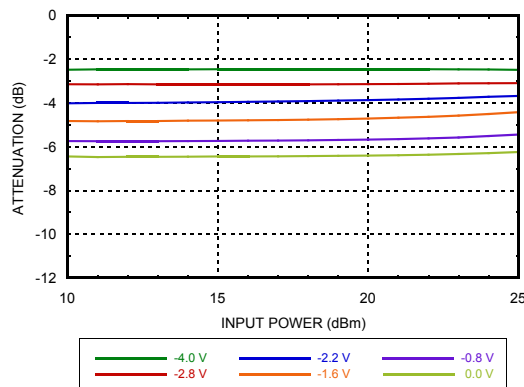

**GaAs MMIC VOLTAGE-VARIABLE  
ATTENUATOR, 5 - 26.5 GHz**

**Insertion Phase vs. Vctrl1, Vctrl2 = -5V**

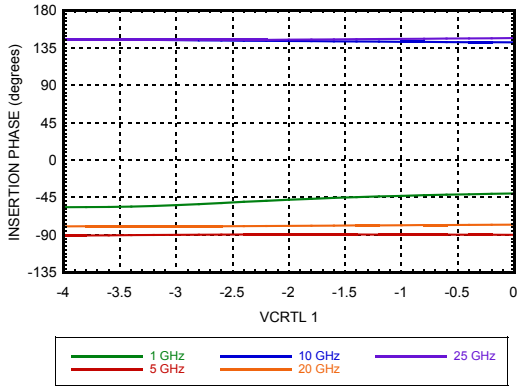

**Insertion Phase vs. Vctrl2, Vctrl1 = 0V**

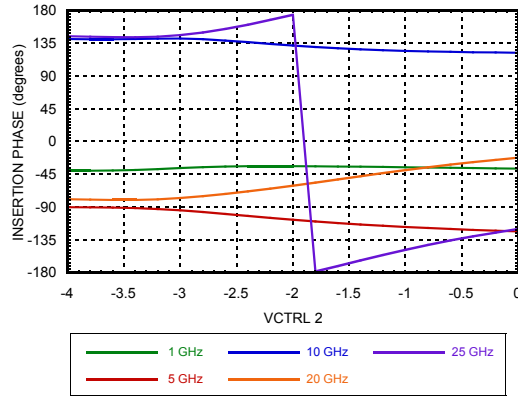

**Input Return Loss  
Vctrl1 = Variable, Vctrl2 = -5V**

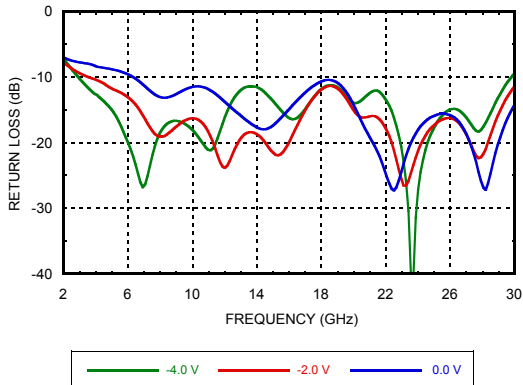

**Input Return Loss  
Vctrl1 = 0V, Vctrl2 = Variable**

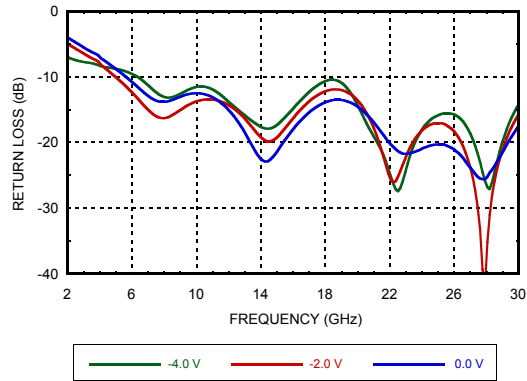

**Output Return Loss  
Vctrl1 = Variable, Vctrl2 = -5V**

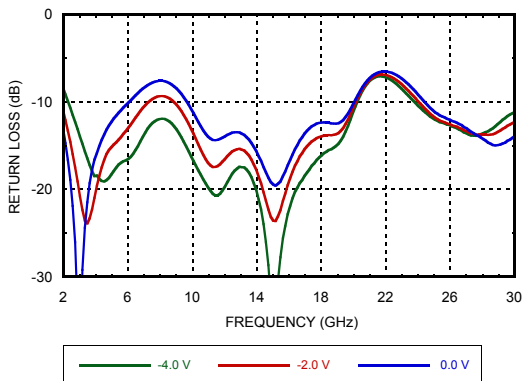

**Output Return Loss  
Vctrl1 = 0V, Vctrl2 = Variable**

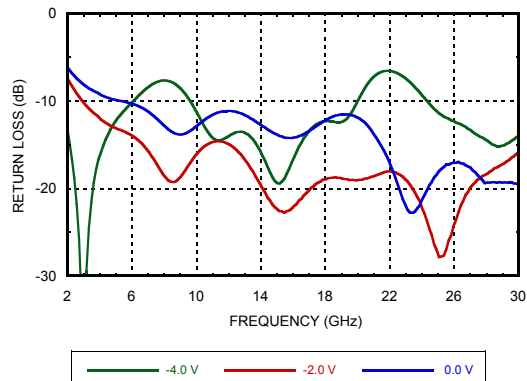

**GaAs MMIC VOLTAGE-VARIABLE ATTENUATOR, 5 - 26.5 GHz**

**Input IP3 vs Input Power @ 10 GHz**  
Vctrl1 = Variable, Vctrl2 = -5V

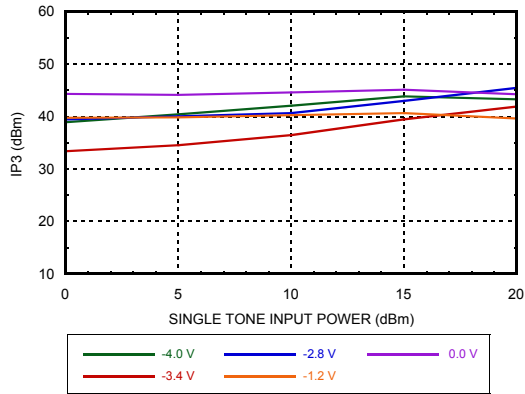

**Input IP3 vs. Input Power Over Frequency**  
Vctrl1 = -2.0V, Vctrl2 = -5V (Worst Case IP3)

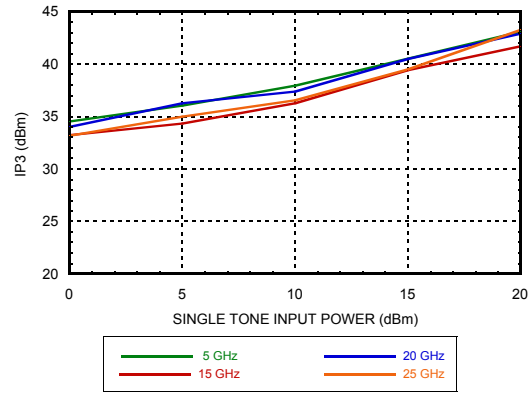

**Input IP3 vs. Input Power Over Temperature**  
@ 10 GHz, Vctrl1 = -2.0V, Vctrl2 = -5V

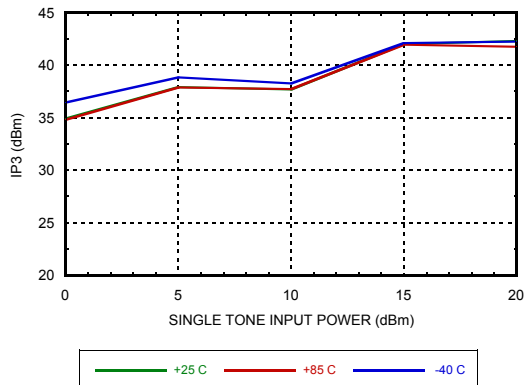

**Attenuation vs. Frequency over Vctrl**  
Vctrl1 = Vctrl2

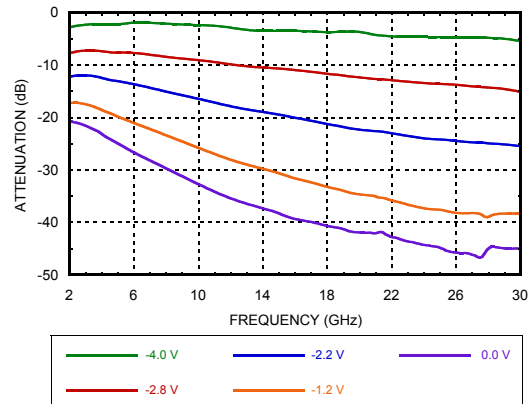

**Attenuation vs. Vctrl over Temperature**  
@ 10 GHz, Vctrl1 = Vctrl2

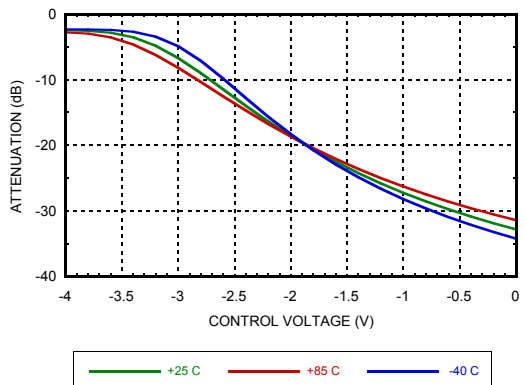

**Attenuation vs. Input Power over Vctrl**  
Vctrl1 = Vctrl2

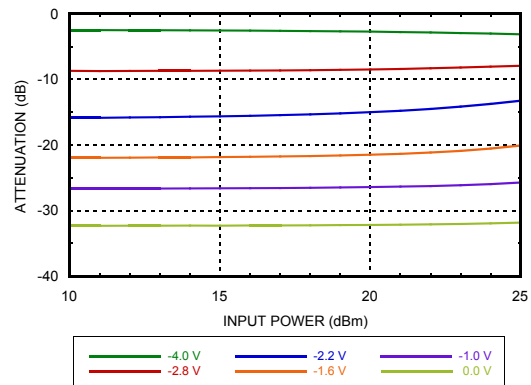

## GaAs MMIC VOLTAGE-VARIABLE ATTENUATOR, 5 - 26.5 GHz

**Input Return Loss, Vctrl1 = Vctrl2**

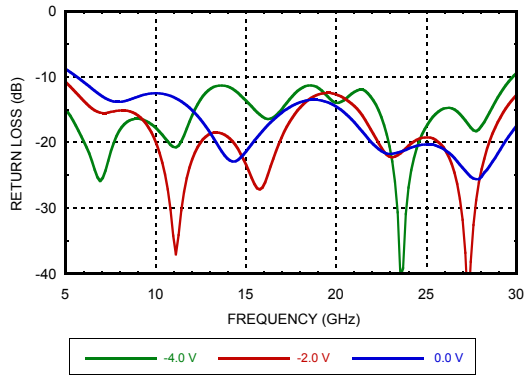

**Output Return Loss, Vctrl1 = Vctrl2**

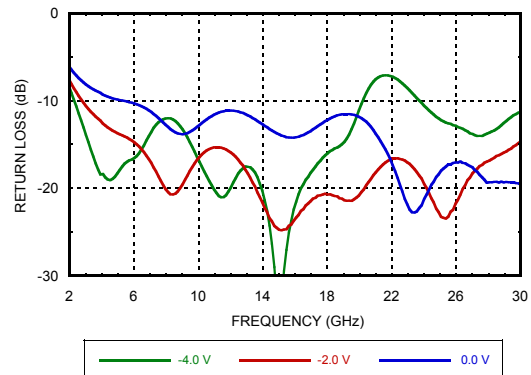

**Input IP3 vs. Input Power Over Vctrl @ 10 GHz, Vctrl1 = Vctrl2**

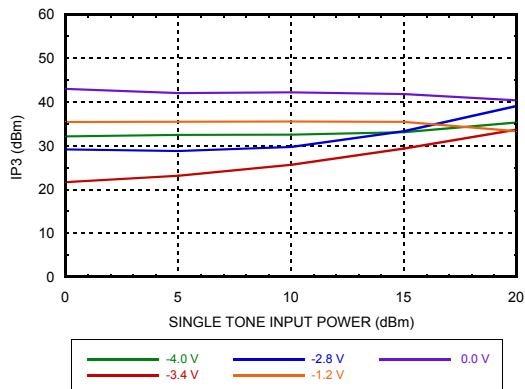

### Absolute Maximum Ratings

RF Input Power	+30 dBm
Control Voltage Range	+0.3 to -6V
Channel Temperature	175 °C
Continuous Pdiss (T = 85 °C)	1W
Thermal Resistance (Channel to ground paddle)	66 °C/W
Storage Temperature	-65 to +150 °C
Operating Temperature	-40 to +85 °C
ESD Sensitivity (HBM)	Class 0 (Passed 150V)

### Control Voltages

Vctrl1	-5 to 0V @ 10 μA
Vctrl2	-5 to 0V @ 10 μA



ELECTROSTATIC SENSITIVE DEVICE  
OBSERVE HANDLING PRECAUTIONS

## GaAs MMIC VOLTAGE-VARIABLE ATTENUATOR, 5 - 26.5 GHz

### Outline Drawing

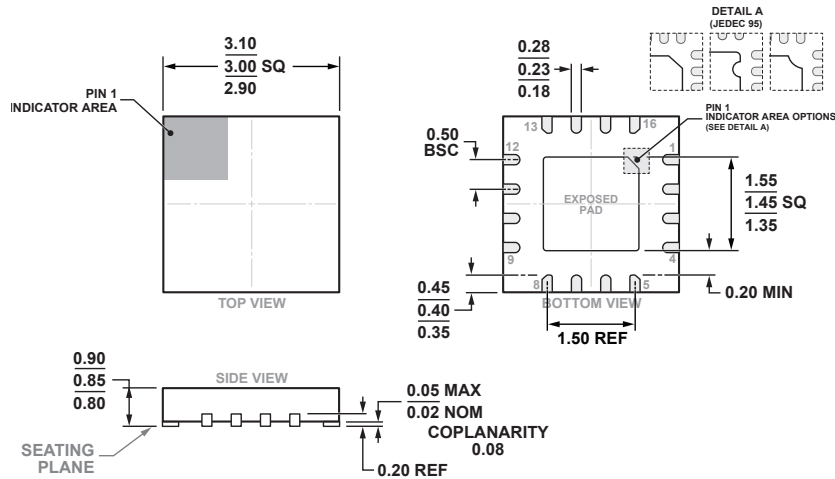

COMPLIANT WITH JEDEC STANDARDS MO-220-VEED-4

16-Lead Lead Frame Chip Scale Package [LFCSP]  
3 x 3 mm Body and 0.85 mm Package Height  
(CP-16-52)

Dimensions shown in millimeters

### Package Information

Part Number	Package Body Material	Lead Finish	MSL Rating	Package Marking <sup>[1]</sup>
HMC712ALP3CE	RoHS-compliant Low Stress Injection Molded Plastic	100% matte Sn	MSL3 <sup>[2]</sup>	H712A XXXX

[1] 4-Digit lot number XXXX

[2] Max peak reflow temperature of 260 °C

## GaAs MMIC VOLTAGE-VARIABLE ATTENUATOR, 5 - 26.5 GHz

### Pin Descriptions

Pin Number	Function	Description	Interface Schematic
1, 2, 4, 9, 11, 12 Ground Paddle	GND	Ground paddle must be connected to RF/DC ground.	
3	RFIN	This pin is DC coupled and matched to 50 Ohms. A blocking capacitor is required if RF line potential is not equal to 0V.	
5, 8, 13 - 16	N/C	These pins should be connected to PCB RF ground to maximize performance.	
6	Vctrl1	Control Voltage 1	
7	Vctrl2	Control Voltage 2	
10	RFOUT	This pin is DC coupled and matched to 50 Ohms. A blocking capacitor is required if RF line potential is not equal to 0V.	

### Application Circuit

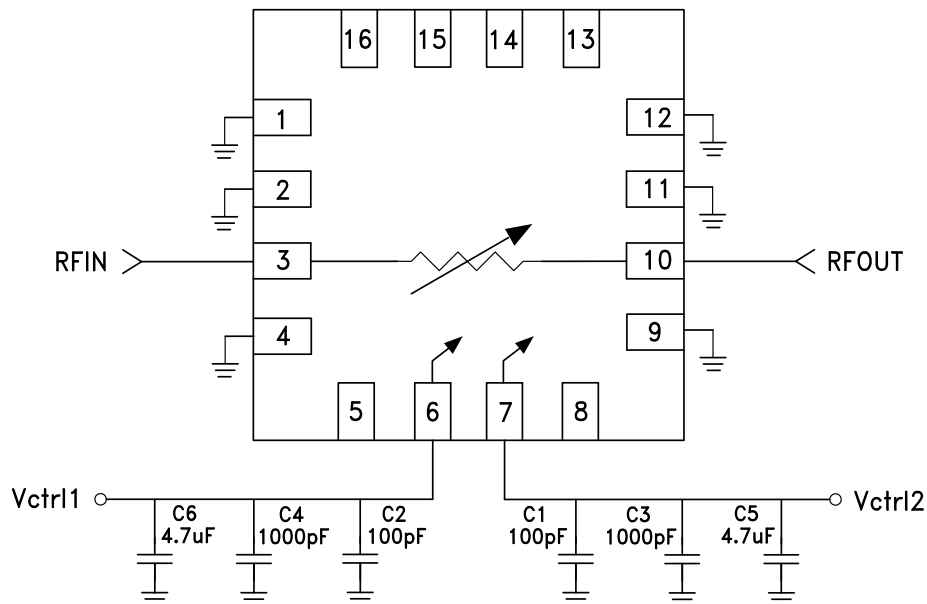



## GaAs MMIC VOLTAGE-VARIABLE ATTENUATOR, 5 - 26.5 GHz

### Evaluation PCB

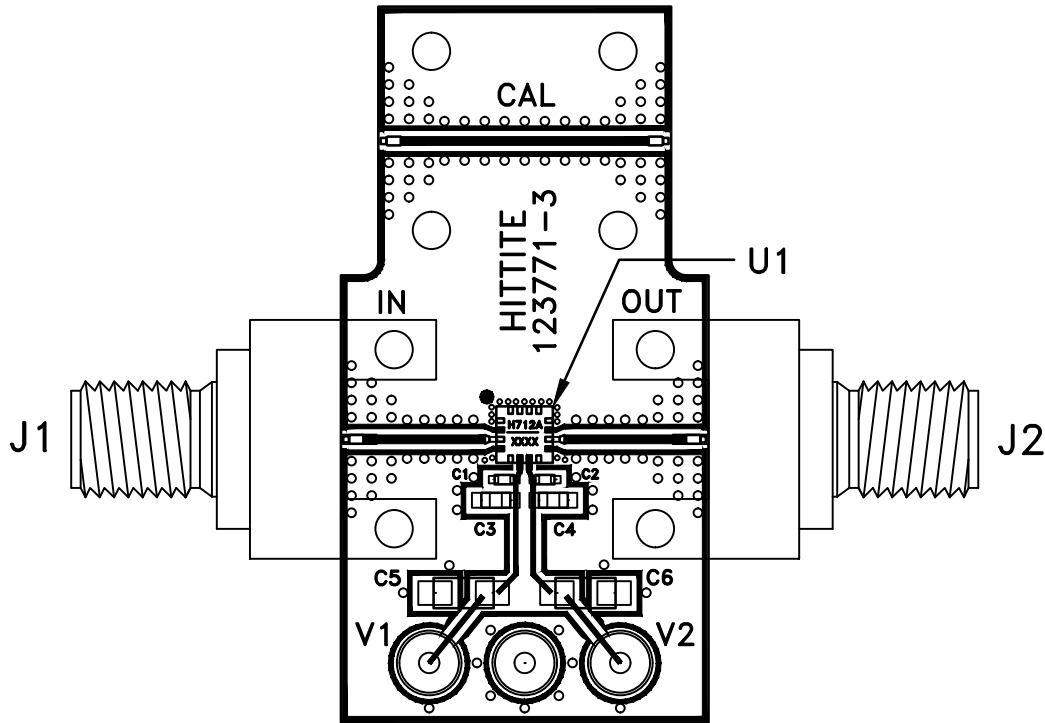

### List of Materials for EV1HMC712ALP3CE [1]

Item	Description
J1, J2	PCB Mount SMA RF Connector
C1, C2	100 pF Capacitor, 0402 Pkg.
C3, C4	1000 pF Capacitor, 0603 Pkg.
C5, C6	4.7 $\mu$ F Capacitor, Tantalum
V1, V2	DC Pin
U1	HMC712ALP3CE Voltage Variable Attenuator
PCB [2]	123771 Evaluation PCB

[1] Reference this number when ordering complete evaluation PCB

[2] Circuit Board Material: Arlon 25FR or Rogers 4350

The circuit board used in the final application should use RF circuit design techniques. Signal lines should have 50 Ohm impedance while the package ground leads and exposed paddle should be connected directly to the ground plane similar to that shown. A sufficient number of via holes should be used to connect the top and bottom ground planes. The evaluation circuit board shown is available from Analog Devices upon request.