



Is Now Part of



ON Semiconductor®

To learn more about ON Semiconductor, please visit our website at
www.onsemi.com

Please note: As part of the Fairchild Semiconductor integration, some of the Fairchild orderable part numbers will need to change in order to meet ON Semiconductor's system requirements. Since the ON Semiconductor product management systems do not have the ability to manage part nomenclature that utilizes an underscore (_), the underscore (_) in the Fairchild part numbers will be changed to a dash (-). This document may contain device numbers with an underscore (_). Please check the ON Semiconductor website to verify the updated device numbers. The most current and up-to-date ordering information can be found at www.onsemi.com. Please email any questions regarding the system integration to Fairchild_questions@onsemi.com.

ON Semiconductor and the ON Semiconductor logo are trademarks of Semiconductor Components Industries, LLC dba ON Semiconductor or its subsidiaries in the United States and/or other countries. ON Semiconductor owns the rights to a number of patents, trademarks, copyrights, trade secrets, and other intellectual property. A listing of ON Semiconductor's product/patent coverage may be accessed at www.onsemi.com/site/pdf/Patent-Marking.pdf. ON Semiconductor reserves the right to make changes without further notice to any products herein. ON Semiconductor makes no warranty, representation or guarantee regarding the suitability of its products for any particular purpose, nor does ON Semiconductor assume any liability arising out of the application or use of any product or circuit, and specifically disclaims any and all liability, including without limitation special, consequential or incidental damages. Buyer is responsible for its products and applications using ON Semiconductor products, including compliance with all laws, regulations and safety requirements or standards, regardless of any support or applications information provided by ON Semiconductor. "Typical" parameters which may be provided in ON Semiconductor data sheets and/or specifications can and do vary in different applications and actual performance may vary over time. All operating parameters, including "Typicals" must be validated for each customer application by customer's technical experts. ON Semiconductor does not convey any license under its patent rights nor the rights of others. ON Semiconductor products are not designed, intended, or authorized for use as a critical component in life support systems or any FDA Class 3 medical devices or medical devices with a same or similar classification in a foreign jurisdiction or any devices intended for implantation in the human body. Should Buyer purchase or use ON Semiconductor products for any such unintended or unauthorized application, Buyer shall indemnify and hold ON Semiconductor and its officers, employees, subsidiaries, affiliates, and distributors harmless against all claims, costs, damages, and expenses, and reasonable attorney fees arising out of, directly or indirectly, any claim of personal injury or death associated with such unintended or unauthorized use, even if such claim alleges that ON Semiconductor was negligent regarding the design or manufacture of the part. ON Semiconductor is an Equal Opportunity/Affirmative Action Employer. This literature is subject to all applicable copyright laws and is not for resale in any manner.



ON Semiconductor®

March 2017

FAN6204A mWSaver™ Synchronous Rectification Controller for Flyback and Forward Freewheeling Rectification

Features

- mWSaver™ Technology:
 - Internal Green Mode to Stop SR Switching for Lower No-Load Power Consumption
 - 1.1 mA Ultra-Low Green Mode Operating Current
- SR Controller
- Suited for Flyback Converter in QR, DCM, and CCM Operation
- Suited for Forward Freewheeling Rectification
- PWM Frequency Tracking with Secondary-Side Winding Voltage Detection
- Ultra-Low V_{DD} Operating Voltage for Various Output Voltage Applications (5 V~24 V)
- V_{DD} Pin Over-Voltage Protection (OVP)
- 12 V (Typical) Gate Driver Clamp
- 8-Pin SOP Package

Applications

- AC/DC NB Adapters
- Open-Frame SMPS
- Battery Charger

Description

FAN6204A is a secondary-side synchronous rectification (SR) controller to drive SR MOSFET for improving efficiency. The IC is suitable for flyback converters and forward free-wheeling rectification.

FAN6204A can be applied in continuous or discontinuous conduction mode (CCM and DCM) and quasi-resonant (QR) flyback converters based on the proprietary innovative linear-predict timing-control technique. The benefits of this technique include a simple control method without current-sense circuitry to accomplish noise immunity.

With PWM frequency tracking and secondary-side winding voltage detection, FAN6204A can operate in both fixed- and variable-frequency systems.

In Green Mode, the SR controller stops all SR switching operation to reduce the operating current. Power consumption is maintained at minimum level in light-load condition.

Ordering Information

Part Number	Operating Temperature Range	Package	Packing Method
FAN6204AMX	-40°C to +105°C	8-Pin, Small Outline Package (SOP)	Tape & Reel

FAN6204A — mWSaver™ Synchronous Rectification Controller for Flyback and Forward Freewheeling Rectification

Marking Information

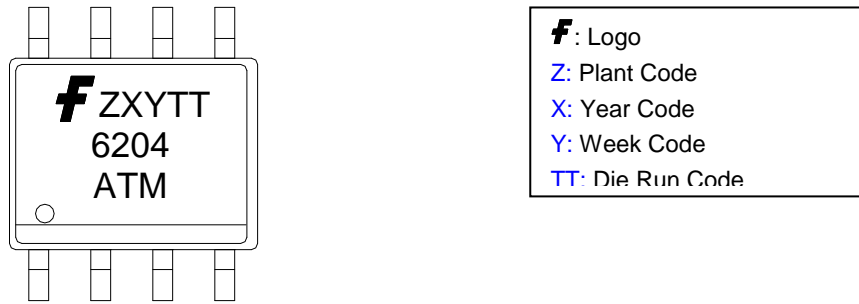

Figure 4. Marking Diagram

Pin Configuration

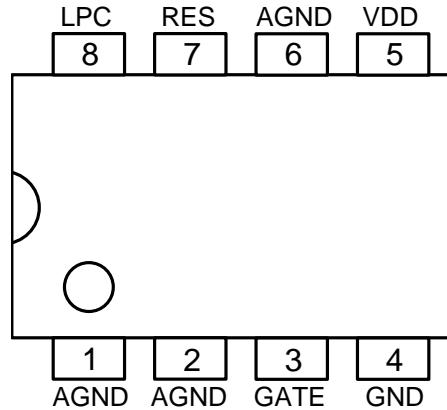

Figure 5. Pin Assignments

Pin Definitions

Pin #	Name	Description
1	AGND	Signal Ground.
2	AGND	Signal Ground.
3	GATE	Driver Output. The totem-pole output driver for driving the power MOSFET.
4	GND	Ground. MOSFET source connection.
5	VDD	Power Supply. The threshold voltages for startup and turn-off are 4.8 V and 4.5 V, respectively.
6	AGND	Signal Ground.
7	RES	Reset Control of Linear Predict. The RES pin is used to detect the output voltage level through a voltage divider. An internal current source, I_{DISCHR} , is modulated by the voltage level on the RES pin.
8	LPC	Winding Detection. This pin is used to detect the voltage on the winding during the on-time period of the primary GATE.

Absolute Maximum Ratings

Stresses exceeding the absolute maximum ratings may damage the device. The device may not function or be operable above the recommended operating conditions and stressing the parts to these levels is not recommended. In addition, extended exposure to stresses above the recommended operating conditions may affect device reliability. The absolute maximum ratings are stress ratings only.

Symbol	Parameter	Min.	Max.	Unit
V _{DD}	DC Supply Voltage		30	V
V _L	LPC, RES	-0.3	7.0	V
P _D	Power Dissipation(T _A =25°C)		0.8	W
Θ _{JA}	Thermal Resistance (Junction-to-Air)		151	°C/W
Θ _{JC}	Thermal Resistance (Junction-to-Case)		58	°C/W
T _{STG}	Storage Temperature Range	-55	+150	°C
T _J	Junction Temperature	-40	+150	°C
T _L	Lead Temperature (Soldering 10 Seconds)		+260	°C
ESD	Human Body Model		5	kV
	Charged Device Model		2	

Notes:

1. Stresses beyond those listed under Absolute Maximum Ratings may cause permanent damage to the device.
2. All voltage values, except differential voltages, are given with respect to GND pin.

Electrical Characteristics

V_{DD}=15 V and T_A=25°C unless otherwise noted.

Symbol	Parameter	Conditions	Min.	Typ.	Max.	Unit
V _{OP}	Continuously Operating Voltage		V _{DD-OFF}		28.5	V
V _{DD-ON}	Turn-On Threshold Voltage		4.3	4.8	5.3	V
V _{DD-OFF}	Turn-Off Threshold Voltage		4.0	4.5	5.0	V
V _{DD-HYST}	V _{DD-ON} – V _{DD-OFF}		0.1	0.3	0.5	V
I _{DD-OP}	Operating Current	V _{DD} =15 V, L _{PC} =50 kHz, MOSFET C _{ISS} =6000 pF		7	8	mA
I _{DD-GREEN}	Operating Current in Green Mode	V _{DD} =15 V		1.1	1.3	mA
I _{DD-ST}	Startup Current	V _{DD} < V _{DD-ON}		150	200	μA
V _{DD-OVP}	V _{DD} Over-Voltage Protection		26.0	27.5	28.5	V
V _{DD-OVP-HYST}	Hysteresis Voltage for V _{DD} OVP		1.8	2.1	2.4	V
t _{VDD-OVP}	V _{DD} OVP Debounce Time		40	70	100	μs
Output Driver Section						
V _Z	Gate Output Clamp Voltage		10	12	14	V
V _{OL}	Output Voltage Low	V _{DD} =6 V, I _O =50 mA			0.5	V
V _{OH}	Output Voltage High	V _{DD} =6 V, I _O =50 mA	4			V
t _R	Rising Time	V _{DD} =12 V, C _L =6 nF, OUT=2 V~9 V	30	70	120	ns
		V _{DD} =6 V, C _L =6 nF, OUT=0.4 V~4 V	70	120	170	ns
t _F	Falling Time	V _{DD} =12 V, C _L =6 nF, OUT=9 V~2 V	20	50	100	ns
		V _{DD} =6 V, C _L =6 nF, OUT=4 V~0.4 V	20	90	130	ns
t _{PD-HIGH-LPC}	Propagation Delay to Turn-on Gate (LPC Trigger)	t _R : 0 V~2 V, V _{DD} =12 V		250		ns
t _{PD-LOW-LPC}	Propagation Delay to Turn-off Gate (LPC Trigger) ⁽³⁾	t _F : 100%~90%, V _{DD} =12 V		180		ns
t _{MAX-PERIOD}	Limitation between LPC Rising Edge to Gate Falling Edge		22.5	25.0	28.0	μs
V _{PMOS-ON}	Internal PMOS Turn-On to Pull-HIGH Gate ⁽³⁾			8.3		V
V _{PMOS-ON-HYS}	Hysteresis Voltage On ⁽³⁾			0.9		V
t _{INHIBIT}	Gate Inhibit Time	M2 Option (Enable)	1.6	2.2	2.8	μs
V _{GATE-PULL-HIGH}	Gate Pull-HIGH Voltage	V _{DD} =5 V	4.5			V
LPC Section						
t _{BNK}	Blanking Time for Charging C _T		400	500	600	ns
t _{DELAY-COMP}	Sampling Continuous Time for t _{BNK} Compensation ⁽³⁾			1		μs
V _{LPC-SOURCE}	LPC Lower Clamp Voltage	Source I _{LPC} =5 μA	0.1	0.2	0.3	V
I _{LPC-SOURCE}	LPC Source Current	V _{LPC} =0 V	40	80	120	μA
V _{LPC-EN}	Threshold Voltage to Enabled SR Switching	V _{LPC-EN} =V _{LPC-HIGH} x 0.83 at V _{LPC-HIGH} x 0.83 < 2 V, V _O =15 V, V _O =V _{DD} , V _{LPC-HIGH} =1.2 V	0.85	1.00	1.15	V
V _{EN-CLAMP}	Threshold Clamp Voltage to Enable SR Switching	V _{LPC-EN} =2 V at V _{LPC-HIGH} x 0.83 > 2 V		2		V
V _{LPC-TH-HIGH}	Threshold Voltage on LPC Rising Edge	Decrease V _{LPC} from 0.05 V _O +0.05, V _O =15 V, V _O =V _{DD}	0.7	0.8	0.9	V
t _{BNK-DIS}	Blanking Time at the Falling Edge of V _{LPC}	Prevent LPC Spike to Turn-Off Gate		350		ns

Electrical Characteristics

V_{DD}=15 V and T_A=25°C unless otherwise noted.

Symbol	Parameter	Conditions	Min.	Typ.	Max.	Unit
LPC Section (Continued)						
V _{LPC-CLAMP-H}	Higher Clamp Voltage ⁽³⁾			6		V
V _{LPC-DIS}	LPC Voltage to Disable SR Gate		4.0	4.2	4.4	V
t _{LPC-HIGH}	Debounce Time for Disable SR Gate			1		μs
RES Section						
V _{RES-EN}	Threshold Voltage of V _{RES} to Enable SR MOSFET		0.60	0.75	0.90	V
t _{RES-LOW}	Debounce Time to Disable RES Function			1	2	μs
V _{RES-CLAMP-H}	Higher Clamp Voltage ⁽³⁾			6		V
K _{RES-DROP}	RES Dropping Protection Ratio within One Cycle			90		%
t _{RES-DROP}	Debounce Time for RES Voltage-Drop Protection			1.5		μs
Internal Timing Section						
t _{CT}	Linear Operation Range of C _T	V _{LPC} =1.5 V	27	30	33	μs
V _{LPC-OP}	Linear Operation Range of LPC to Charge C _T	V _{DD} <5 V	0.8		3.4	V
		V _{DD} >5 V	0.8		4.0	V
V _{RES-OP}	Linear Operation Range of RES to Discharge C _T	V _{DD} <5 V	0.8		3.4	V
		V _{DD} >5 V	0.8		4.0	V
Ratio _{LPC-RES}	Ratio Between LPC and RES		4.65	5.00	5.35	
t _{LPC-EN}	Minimum LPC Time to Enable SR Switching, V _{LPC-HIGH} >V _{LPC-EN}		0.9	1.1	1.3	μs
t _{gate-limit}	t _{on-SR} (n+1) < t _{gate-limit} × t _{on-SR} (n)		105		120	%
Green Section						
t _{GREEN-OFF}	C _T Capacitor t _{DIS} Time to Leave Green Mode	f _S =65 kHz	4.60	5.35	6.10	μs
t _{GREEN-ON}	C _T Capacitor t _{DIS} Time to Enter Green Mode	f _S =65 kHz	4.25	4.80	5.35	μs
t _{GREEN-TIME-enter}	Cycle Time to Enter Green Mode	C _T Discharge Time < t _{GREEN-ON}		3		Times
t _{GREEN-TIME-leave}	Cycle Time to Leave Green Mode	C _T Discharge Time > t _{GREEN-OFF}		7		Times
t _{GREEN-ENTER}	No Gate Signal to Enter Green Mode ⁽³⁾			75		μs
Causal Function Section						
t _{CAUSAL}	Once t _{S-PWM} (n+1) > t _{CAUSAL} × t _{S-PWM} (n), SR Stops Switching and Enter Green Mode	f _S =65 kHz → 40 kHz		120		%
t _{DEAD-CAUSAL}	SR Turn-off Dead Time by Causal Function	f _S =65 kHz	380	580	780	ns
t _{DEAD-CFR}	Dead Time to Shrink SR ON Time	CFR (Causal Function Regulator)		150		ns
t _{DEAD-RE-CFR}	SR ON Time Narrowed Down Width when t _{DEAD-CFR} Triggered			1.5		μs
Internal Over-Temperature Protection Section						
T _{OTP}	Internal Threshold Temperature for OTP ⁽³⁾			140		°C
T _{OTP-HYST}	Hysteresis Temperature for Internal OTP ⁽³⁾			20		°C

Note:

- Guaranteed by design.

Typical Performance Characteristics

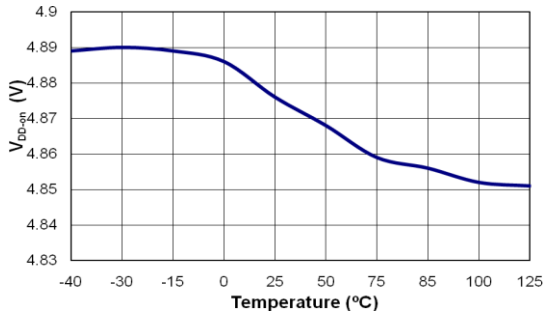

Figure 6. Turn-On Threshold Voltage

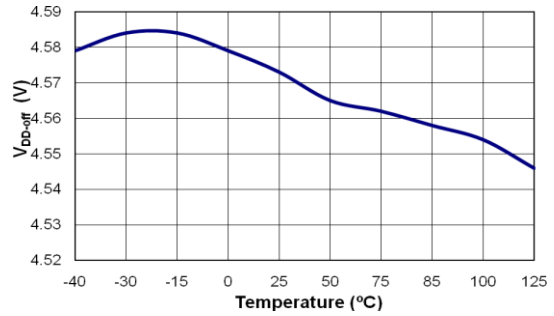

Figure 7. Turn-Off Threshold Voltage

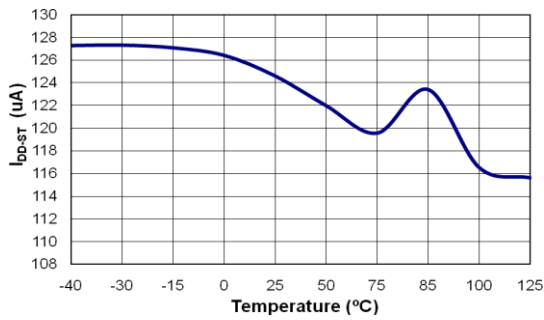

Figure 8. Startup Current

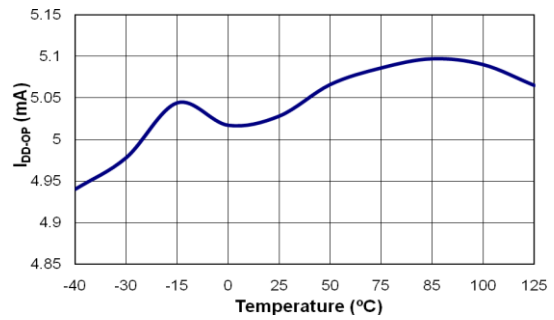

Figure 9. Operating Current

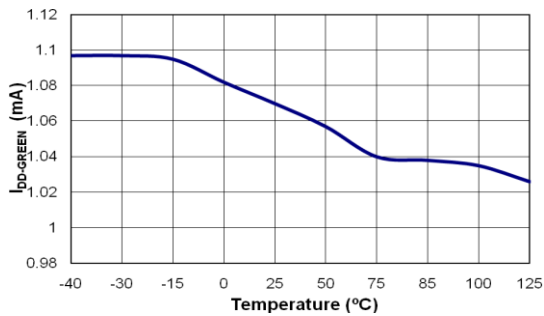

Figure 10. Operating Current in Green Mode

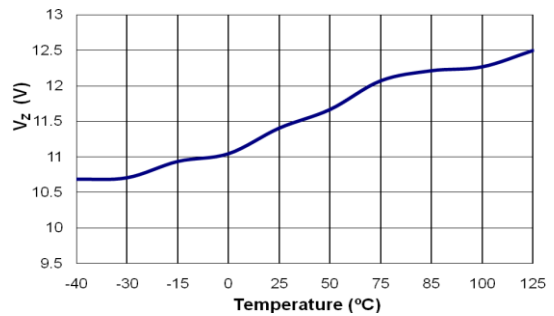

Figure 11. Gate Output Clamping Voltage

Typical Performance Characteristics (Continued)

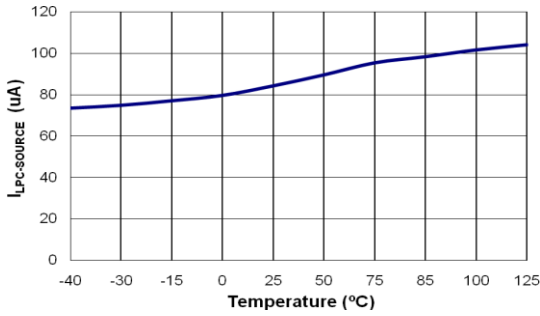

Figure 12. LPC Source Current

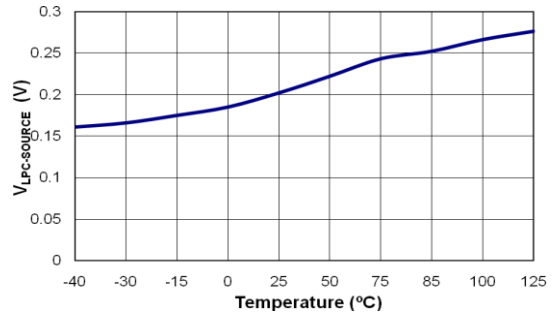

Figure 13. LPC Lower Clamp Voltage

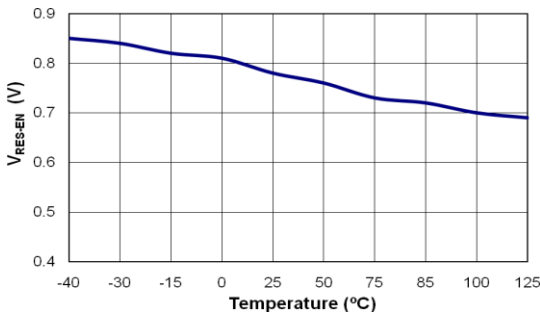

Figure 14. Threshold Voltage of V_{RES}

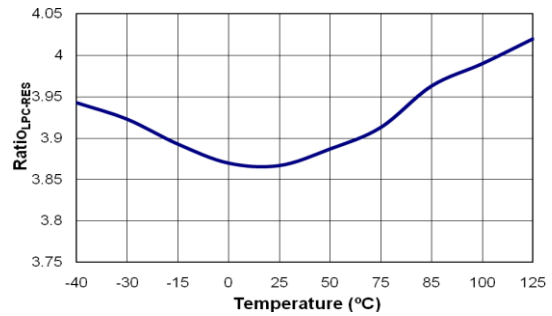

Figure 15. Ratio between LPC and RES

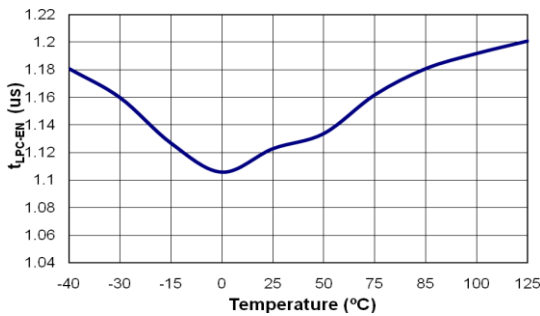

Figure 16. Minimum LPC Enable Time

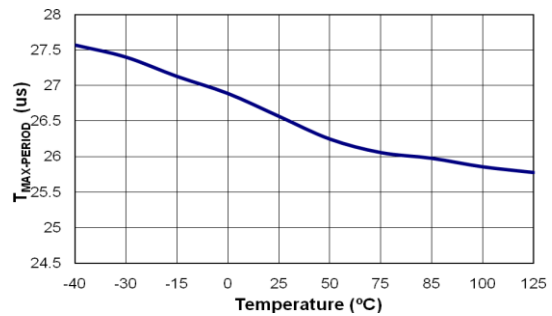

Figure 17. Maximum Period between LPC Rising Edge to Gate Falling Edge

Functional Description

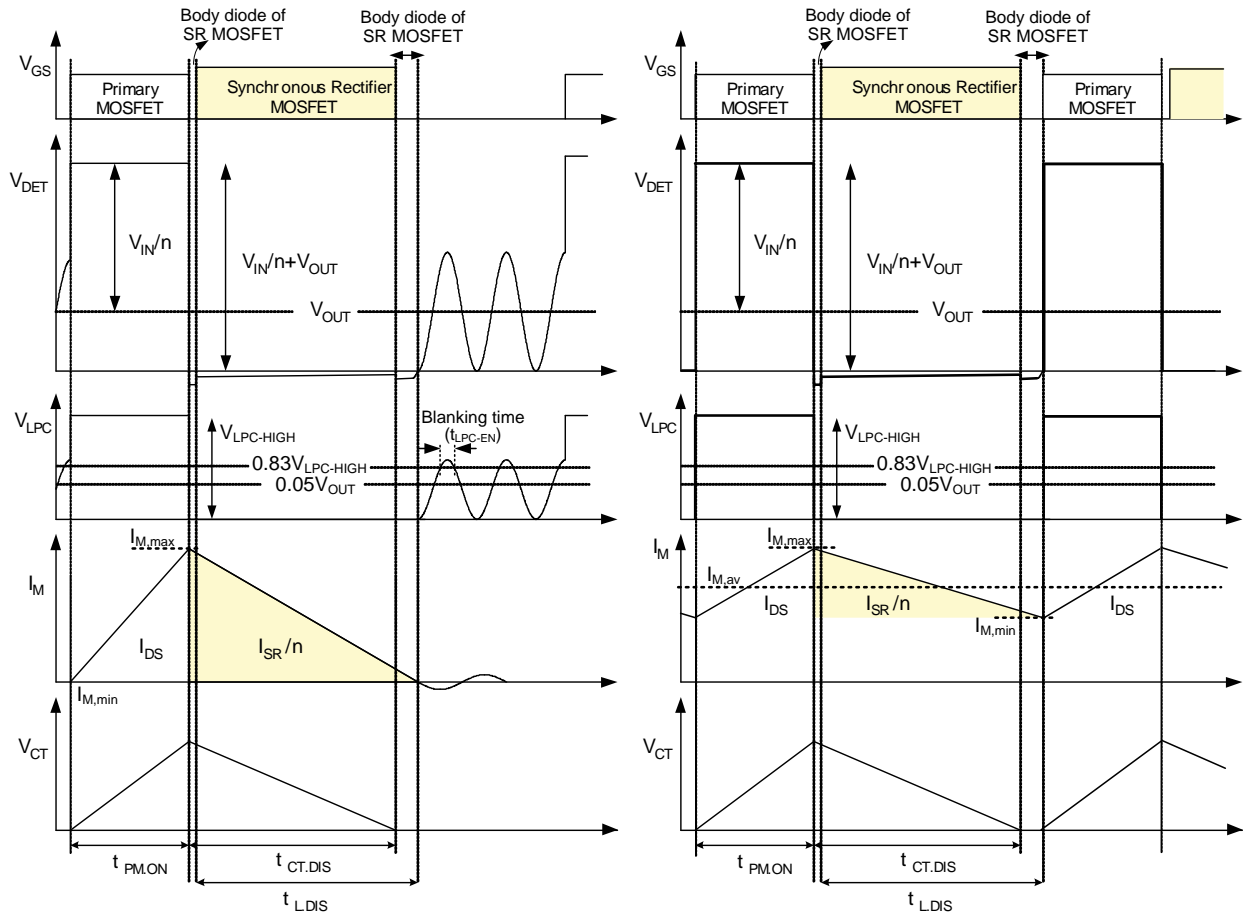

Figure 18. Typical Waveforms of Linear-Predict Timing Control in CCM and DCM/QR Flyback

Linear Predict Timing Control

The SR MOSFET turn-off timing is determined by linear-predict timing control and the operation principle is based on the volt-second balance theorem. The volt-second balance theorem states that the inductor average voltage is zero during a switching period in steady state, so the charge voltage and charge time product is equal to the discharge voltage and discharge time product. In flyback converters, the charge voltage on the magnetizing inductor is input voltage (V_{IN}), while the discharge voltage is nV_{OUT} , as the typical waveforms show in Figure 18. The following equation can be drawn:

$$V_{IN} \cdot t_{PM,ON} = n \cdot V_{OUT} \cdot t_{L,DIS} \quad (1)$$

where $t_{PM,ON}$ is inductor charge time and $t_{L,DIS}$ is inductor discharge time.

FAN6204A uses the LPC and RES pins with two sets of voltage dividers to sense DET voltage (V_{DET}) and output voltage (V_{OUT}), respectively; so V_{IN}/n , $t_{PM,ON}$, and V_{OUT} can be obtained. As a result, $t_{L,DIS}$, which is the on-time of SR MOSFET, can be predicted by Equation (1). As shown in Figure 18, the SR MOSFET is turned on when the SR MOSFET body diode starts conducting and DET voltage drops to zero. The SR MOSFET is turned off by linear-predict timing control.

Circuit Realization

The linear-predict timing-control circuit generates a replica (V_{CT}) of magnetizing current of flyback transformer using internal timing capacitor (C_T), as shown in Figure 19. Using the internal capacitor voltage, the inductor discharge time ($t_{L,DIS}$) can be detected indirectly, as shown in Figure 18. When C_T is discharged to zero, the SR controller turns off the SR MOSFET.

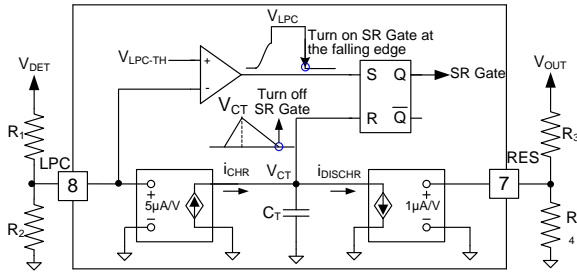

Figure 19. Simplified Linear-Predict Block

The voltage-second balance equation for the primary-side inductance of the flyback converter is given in Equation (1). Inductor current discharge time is given as:

$$t_{L.DIS} = \frac{V_{IN} \cdot t_{PM.ON}}{n \cdot V_{OUT}} \quad (2)$$

The voltage scale-down ratio between RES and LPC is defined as K below:

$$K = \frac{R_4 / (R_3 + R_4)}{R_2 / (R_1 + R_2)} \quad (3)$$

During $t_{PM.ON}$, the charge current of C_T is $i_{CHR} - i_{DISCHR}$, while during $t_{L.DIS}$, the discharge current is i_{DISCHR} . As a result, the current-second balance equation for internal timing capacitor (C_T) can be derived from:

$$\left(\frac{5}{K} \cdot \left(\frac{V_{IN}}{n} + V_{OUT}\right) - V_{OUT}\right) \cdot t_{PM.ON} = V_{OUT} \cdot t_{CT.DIS} \quad (4)$$

Therefore, the discharge time of C_T is given as:

$$t_{CT.DIS} = \frac{\left(\frac{5}{K} \cdot \left(\frac{V_{IN}}{n} + V_{OUT}\right) - V_{OUT}\right) \cdot t_{PM.ON}}{V_{OUT}} \quad (5)$$

When the voltage scale-down ratio between RES and LPC (K) is five (5), the discharge time of C_T ($t_{CT.DIS}$) is the same as inductor current discharge time ($t_{L.DIS}$). However, considering the tolerance of voltage divider resistors and internal circuit, the scale-down ratio (K) should be larger than five (5) to guarantee that $t_{CT.DIS}$ is shorter than $t_{L.DIS}$. It is typical to set K around 5~5.5.

Referring to Figure 18; when LPC voltage is higher than V_{LPC-EN} over a blanking time (t_{LPC-EN}) and lower than $V_{LPC-TH-HIGH}$ ($0.05 V_{OUT}$), then SR MOSFET can be triggered. Therefore, V_{LPC-EN} must be larger than $V_{LPC-TH-HIGH}$ or the SR MOSFET cannot be turned on. When designing the voltage divider of LPC, R_1 and R_2 should be considered as:

$$0.83 \cdot \frac{R_2}{R_1 + R_2} \cdot \left(\frac{V_{IN.MIN}}{n} + V_{OUT}\right) > 0.05 V_{OUT} + 0.3 \quad (6)$$

On the other hand, the linear operation ranges of LPC and RES (1~4 V) should be considered as:

$$\frac{R_2}{R_1 + R_2} \cdot \left(\frac{V_{IN.MAX}}{n} + V_{OUT}\right) < 4 \quad (7)$$

$$\frac{R_4}{R_3 + R_4} \cdot V_{OUT} < 4 \quad (8)$$

CCM Operation

The typical waveforms of CCM operation in steady state are shown as Figure 18. When the primary-side MOSFET is turned on, the energy is stored in L_m . During the on-time of the primary-side MOSFET ($t_{PM.ON}$), the magnetizing current (I_M) increases linearly from $I_{M,min}$ to $I_{M,max}$. Meanwhile, internal timing capacitor (C_T) is charged by current source ($i_{CHR} - i_{DISCHR}$) proportional to V_{IN} , so V_{CT} also increases linearly.

When the primary-side MOSFET is turned off, the energy stored in L_m is released to the output. During the inductor discharge time ($t_{L.DIS}$), the magnetizing current (I_M) decreases linearly from $I_{M,max}$ to $I_{M,min}$. At the same time, the internal timing capacitor (C_T) is discharged by current source (i_{DISCHR}) proportional to V_{OUT} , so V_{CT} also decreases linearly. To guarantee the proper operation of SR, it is important to turn off SR MOSFET just before SR current reaches $I_{M,min}$ so that the body diode of SR MOSFET conducts naturally during the dead time.

DCM / QR Operation

In DCM / QR operation, when primary-side MOSFET is turned off, the energy stored in L_m is fully released to the output at the turn-off timing of primary-side MOSFET. Therefore, the DET voltage continues resonating until the primary-side MOSFET is turned on, as depicted in Figure 18. While DET voltage is resonating, DET voltage and LPC voltage drop to zero by resonance, which can trigger the turn-on of the SR MOSFET. To prevent fault triggering of the SR MOSFET in DCM operation, blanking time is introduced to LPC voltage. The SR MOSFET is not turned on even when LPC voltage drops below $0.05 V_{OUT}$ unless LPC voltage stays above $0.83 V_{LPC-HIGH}$ longer than the blanking time (t_{LPC-EN}). The turn-on timing of the SR MOSFET is inhibited by gate inhibit time ($t_{INHIBIT}$), once the SR MOSFET turns off, to prevent fault triggering.

mWSaver™ Technology

Green-Mode Operation

To minimize the power consumption at light-load condition, the SR circuit is disabled when the load decreases. As illustrated in Figure 20, the discharge times of inductor and internal timing capacitor decrease as load decreases. If the discharge time of the internal timing capacitor is shorter than $t_{GREEN-ON}$ (around $4.8 \mu s$) for more than three cycles, the SR circuit enters Green Mode. Once FAN6204A enters Green Mode, the SR MOSFET stops switching and the major internal block is shut down to further reduce operating current of the SR controller. In Green Mode, the operating current reduces to 1.1 mA. This allows power supplies to meet the most stringent power conservation requirements. When the discharge time of the internal capacitor is longer than $t_{GREEN-OFF}$ (around $5.35 \mu s$) for more than seven cycles, the SR circuit is enabled and resumes the normal operation, as shown in Figure 21.

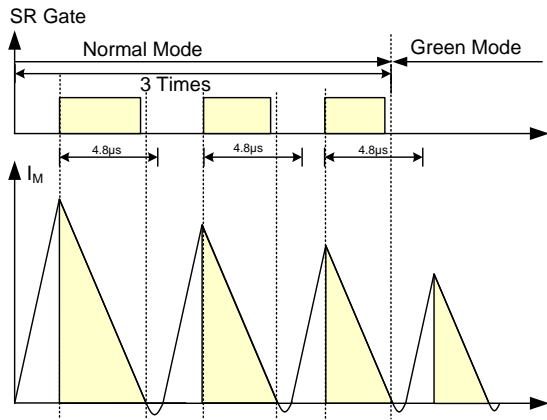

Figure 20. Entering Green Mode

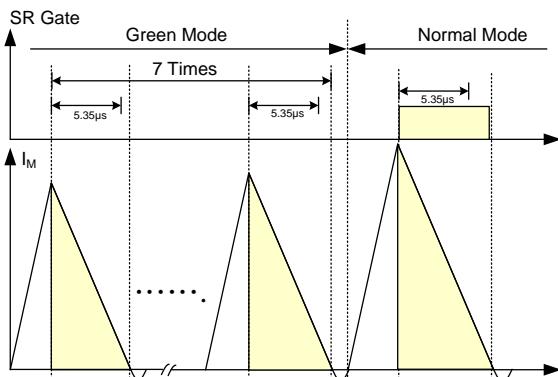

Figure 21. Resuming Normal Operation

Causal Function

Causal function is utilized to limit the time interval (t_{SR-MAX}) from the rising edge of V_{LPC} to the falling edge of the SR gate. t_{SR-MAX} is limited to 97% of previous switching period, as shown in Figure 22. When the system operates at fixed frequency, whether voltage-second balance theorem can be applied or not, causal function can guarantee reliable operation.

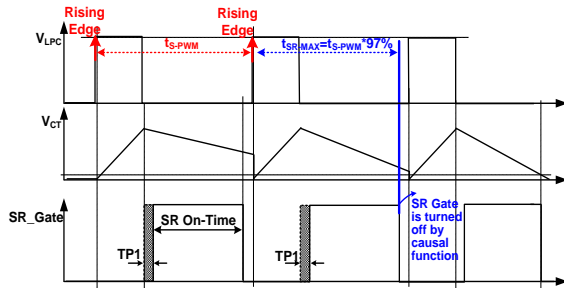

Figure 22. Causal Function Operation

Fault Causal Timing Protection

Fault causal timing protection is utilized to disable the SR gate under some abnormal conditions. Once the switching period ($t_{S-PWM}(n)$) is longer than 120% of previous switching period ($t_{S-PWM}(n-1)$), SR gate is disabled and enters Green Mode, as shown in Figure 23. Since the rising edge of V_{LPC} among switching periods (t_{S-PWM}) is tracked for causal function, the

accuracy of switching period is important. Therefore, if the detected switching period has a serious variation under some abnormal conditions, the SR gate should be terminated to prevent fault trigger.

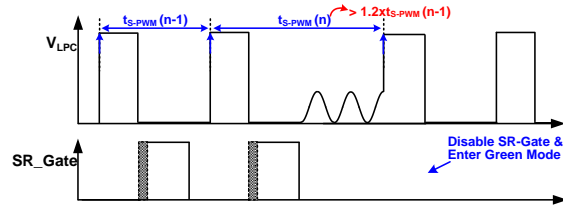

Figure 23. Fault Causal Timing Protection

Gate Expand Limit Protection

Gate expand limit protection controls on-time expansion of the SR MOSFET. Once the discharge time of the internal timing capacitor ($t_{DIS,CT}$) is longer than 115% of previous on time of the SR MOSFET ($t_{ON-SR}(n-1)$); $t_{ON-SR}(n)$ is limited to 115% of $t_{ON-SR}(n-1)$, as shown in Figure 24. When output load changes rapidly from light load to heavy load, voltage-second balance theorem may not be applied. In this transient state, gate expand limit protection is activated to prevent overlap between SR gate and PWM gate.

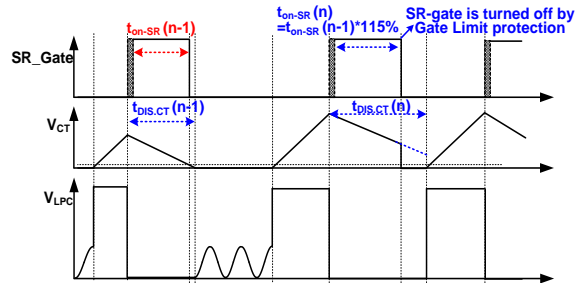

Figure 24. Gate Expand Limit Protection

RES Voltage Drop Protection

RES voltage drop protection prevents V_{RES} dropping too much within a cycle. The V_{RES} is sampled as a reference voltage, V_{RES}' , on V_{LPC} rising edge. Once V_{RES} drops below 90% of V_{RES}' for longer than a debounce time ($t_{RES-DROP}$), the SR gate is turned off immediately, as shown in Figure 25. When output voltage drops rapidly within a switching cycle, voltage-second balance may not be applied, RES dropping protection is activated to prevent overlap.

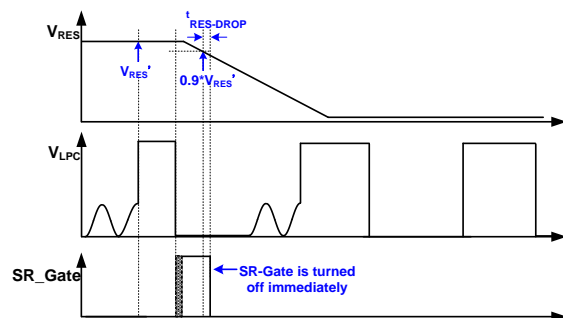

Figure 25. V_{RES} Dropping Protection

LPC Pin Open / Short Protection

LPC-Open Protection: If V_{LPC} is higher than $V_{LPC-DIS}$ (4.2 V) for longer than debounce time $t_{LPC-HIGH}$, FAN6204A stops switching immediately and enters Green Mode. V_{LPC} is clamped at 6 V to avoid LPC pin damage.

LPC-Short Protection: If V_{LPC} is pulled to ground and the charging current of timing capacitor (C_T) is near zero, so that SR gate is not output.

RES Pin Open / Short Protection

RES-Open Protection: If V_{RES} is pulled to HIGH level, the gate signal is extremely small and FAN6204A enters Green Mode. In addition, V_{RES} is clamped at 6 V to avoid RES pin damage.

RES-Short Protection: If V_{RES} is lower than V_{RES-EN} (0.7 V) for longer than debounce time $t_{RES-LOW}$, FAN6204A stops switching immediately and enters Green Mode.

Under-Voltage Lockout (UVLO)

The power ON and OFF V_{DD} threshold voltages are fixed at 4.8 V and 4.5 V, respectively. With an ultra-low V_{DD} threshold voltage, FAN6204A can be used in various output voltage applications.

V_{DD} Pin Over-Voltage Protection (OVP)

Over-voltage conditions are usually caused by an open feedback loop. V_{DD} over-voltage protection prevents damage on the SR MOSFET. When the voltage on V_{DD} pin exceeds 27.5 V, the SR controller stops switching the SR MOSFET.

Over-Temperature Protection (OTP)

To prevent SR gate from fault triggering in high temperatures, internal over-temperature protection is integrated in FAN6204A. Once the temperature is over 140°C, SR gate is disabled until the temperature drops below 120°C.

Physical Dimensions

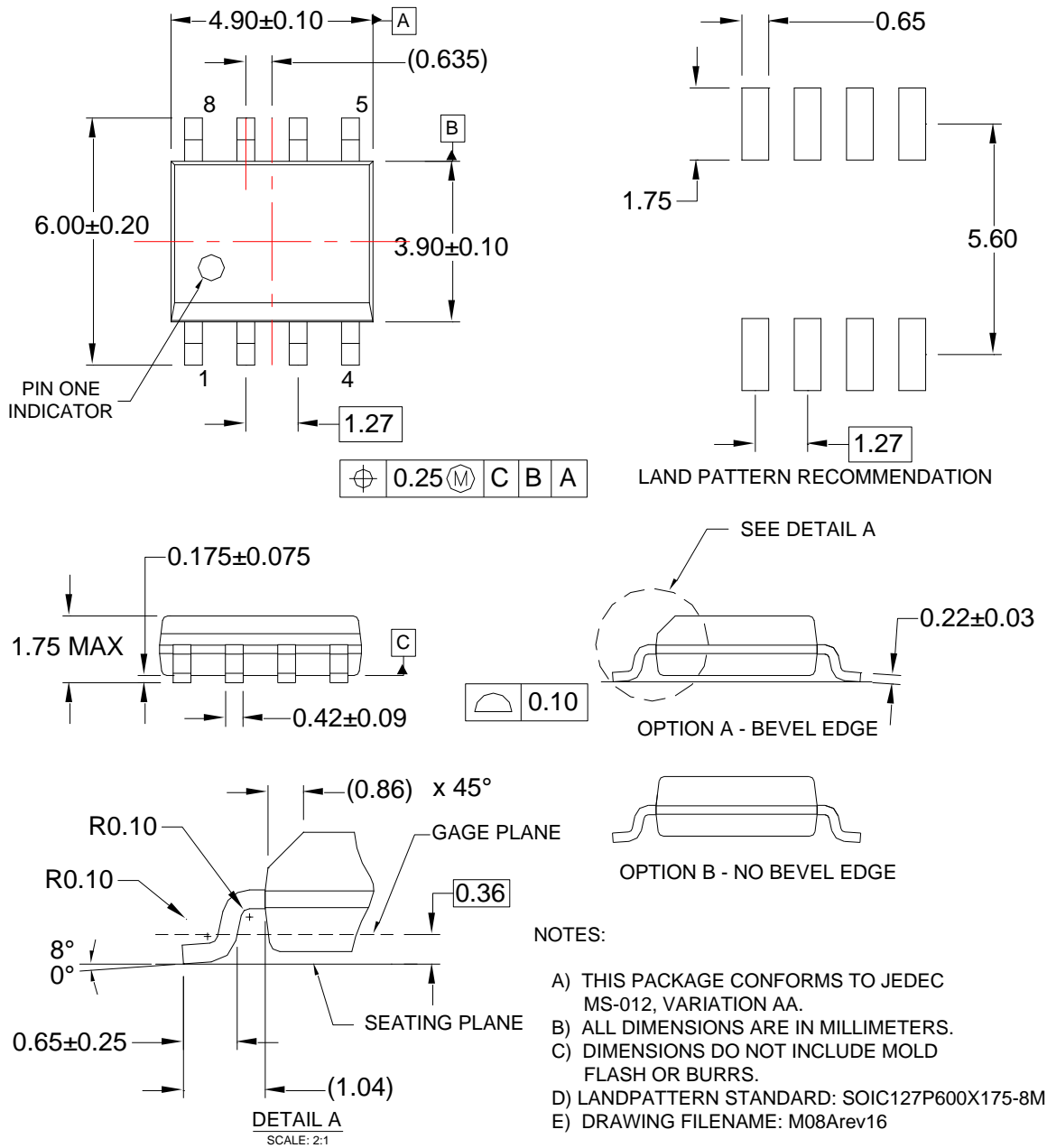

Figure 26. 8-Pin, Small Outline Package (SOP)

ON Semiconductor and the ON Semiconductor logo are trademarks of Semiconductor Components Industries, LLC dba ON Semiconductor or its subsidiaries in the United States and/or other countries. ON Semiconductor owns the rights to a number of patents, trademarks, copyrights, trade secrets, and other intellectual property. A listing of ON Semiconductor's product/patent coverage may be accessed at www.onsemi.com/site/pdf/Patent-Marking.pdf. ON Semiconductor reserves the right to make changes without further notice to any products herein. ON Semiconductor makes no warranty, representation or guarantee regarding the suitability of its products for any particular purpose, nor does ON Semiconductor assume any liability arising out of the application or use of any product or circuit, and specifically disclaims any and all liability, including without limitation special, consequential or incidental damages. Buyer is responsible for its products and applications using ON Semiconductor products, including compliance with all laws, regulations and safety requirements or standards, regardless of any support or applications information provided by ON Semiconductor. "Typical" parameters which may be provided in ON Semiconductor data sheets and/or specifications can and do vary in different applications and actual performance may vary over time. All operating parameters, including "Typicals" must be validated for each customer application by customer's technical experts. ON Semiconductor does not convey any license under its patent rights nor the rights of others. ON Semiconductor products are not designed, intended, or authorized for use as a critical component in life support systems or any FDA Class 3 medical devices or medical devices with a same or similar classification in a foreign jurisdiction or any devices intended for implantation in the human body. Should Buyer purchase or use ON Semiconductor products for any such unintended or unauthorized application, Buyer shall indemnify and hold ON Semiconductor and its officers, employees, subsidiaries, affiliates, and distributors harmless against all claims, costs, damages, and expenses, and reasonable attorney fees arising out of, directly or indirectly, any claim of personal injury or death associated with such unintended or unauthorized use, even if such claim alleges that ON Semiconductor was negligent regarding the design or manufacture of the part. ON Semiconductor is an Equal Opportunity/Affirmative Action Employer. This literature is subject to all applicable copyright laws and is not for resale in any manner.

PUBLICATION ORDERING INFORMATION

LITERATURE FULFILLMENT:

Literature Distribution Center for ON Semiconductor
 19521 E. 32nd Pkwy, Aurora, Colorado 80011 USA
Phone: 303-675-2175 or 800-344-3860 Toll Free USA/Canada
Fax: 303-675-2176 or 800-344-3867 Toll Free USA/Canada
Email: orderlit@onsemi.com

N. American Technical Support: 800-282-9855 Toll Free
 USA/Canada.
Europe, Middle East and Africa Technical Support:
 Phone: 421 33 790 2910
Japan Customer Focus Center
 Phone: 81-3-5817-1050

ON Semiconductor Website: www.onsemi.com
Order Literature: <http://www.onsemi.com/orderlit>
 For additional information, please contact your local
 Sales Representative

ON Semiconductor and  are trademarks of Semiconductor Components Industries, LLC dba ON Semiconductor or its subsidiaries in the United States and/or other countries. ON Semiconductor owns the rights to a number of patents, trademarks, copyrights, trade secrets, and other intellectual property. A listing of ON Semiconductor's product/patent coverage may be accessed at www.onsemi.com/site/pdf/Patent-Marking.pdf. ON Semiconductor reserves the right to make changes without further notice to any products herein. ON Semiconductor makes no warranty, representation or guarantee regarding the suitability of its products for any particular purpose, nor does ON Semiconductor assume any liability arising out of the application or use of any product or circuit, and specifically disclaims any and all liability, including without limitation special, consequential or incidental damages. Buyer is responsible for its products and applications using ON Semiconductor products, including compliance with all laws, regulations and safety requirements or standards, regardless of any support or applications information provided by ON Semiconductor. "Typical" parameters which may be provided in ON Semiconductor data sheets and/or specifications can and do vary in different applications and actual performance may vary over time. All operating parameters, including "Typicals" must be validated for each customer application by customer's technical experts. ON Semiconductor does not convey any license under its patent rights nor the rights of others. ON Semiconductor products are not designed, intended, or authorized for use as a critical component in life support systems or any FDA Class 3 medical devices or medical devices with a same or similar classification in a foreign jurisdiction or any devices intended for implantation in the human body. Should Buyer purchase or use ON Semiconductor products for any such unintended or unauthorized application, Buyer shall indemnify and hold ON Semiconductor and its officers, employees, subsidiaries, affiliates, and distributors harmless against all claims, costs, damages, and expenses, and reasonable attorney fees arising out of, directly or indirectly, any claim of personal injury or death associated with such unintended or unauthorized use, even if such claim alleges that ON Semiconductor was negligent regarding the design or manufacture of the part. ON Semiconductor is an Equal Opportunity/Affirmative Action Employer. This literature is subject to all applicable copyright laws and is not for resale in any manner.

PUBLICATION ORDERING INFORMATION

LITERATURE FULFILLMENT:

Literature Distribution Center for ON Semiconductor
19521 E. 32nd Pkwy, Aurora, Colorado 80011 USA
Phone: 303-675-2175 or 800-344-3860 Toll Free USA/Canada
Fax: 303-675-2176 or 800-344-3867 Toll Free USA/Canada
Email: orderlit@onsemi.com

N. American Technical Support: 800-282-9855 Toll Free
USA/Canada
Europe, Middle East and Africa Technical Support:
Phone: 421 33 790 2910
Japan Customer Focus Center
Phone: 81-3-5817-1050

ON Semiconductor Website: www.onsemi.com
Order Literature: <http://www.onsemi.com/orderlit>
For additional information, please contact your local
Sales Representative