



Is Now Part of



ON Semiconductor®

To learn more about ON Semiconductor, please visit our website at
www.onsemi.com

Please note: As part of the Fairchild Semiconductor integration, some of the Fairchild orderable part numbers will need to change in order to meet ON Semiconductor's system requirements. Since the ON Semiconductor product management systems do not have the ability to manage part nomenclature that utilizes an underscore (_), the underscore (_) in the Fairchild part numbers will be changed to a dash (-). This document may contain device numbers with an underscore (_). Please check the ON Semiconductor website to verify the updated device numbers. The most current and up-to-date ordering information can be found at www.onsemi.com. Please email any questions regarding the system integration to Fairchild_questions@onsemi.com.

ON Semiconductor and the ON Semiconductor logo are trademarks of Semiconductor Components Industries, LLC dba ON Semiconductor or its subsidiaries in the United States and/or other countries. ON Semiconductor owns the rights to a number of patents, trademarks, copyrights, trade secrets, and other intellectual property. A listing of ON Semiconductor's product/patent coverage may be accessed at www.onsemi.com/site/pdf/Patent-Marking.pdf. ON Semiconductor reserves the right to make changes without further notice to any products herein. ON Semiconductor makes no warranty, representation or guarantee regarding the suitability of its products for any particular purpose, nor does ON Semiconductor assume any liability arising out of the application or use of any product or circuit, and specifically disclaims any and all liability, including without limitation special, consequential or incidental damages. Buyer is responsible for its products and applications using ON Semiconductor products, including compliance with all laws, regulations and safety requirements or standards, regardless of any support or applications information provided by ON Semiconductor. "Typical" parameters which may be provided in ON Semiconductor data sheets and/or specifications can and do vary in different applications and actual performance may vary over time. All operating parameters, including "Typicals" must be validated for each customer application by customer's technical experts. ON Semiconductor does not convey any license under its patent rights nor the rights of others. ON Semiconductor products are not designed, intended, or authorized for use as a critical component in life support systems or any FDA Class 3 medical devices or medical devices with a same or similar classification in a foreign jurisdiction or any devices intended for implantation in the human body. Should Buyer purchase or use ON Semiconductor products for any such unintended or unauthorized application, Buyer shall indemnify and hold ON Semiconductor and its officers, employees, subsidiaries, affiliates, and distributors harmless against all claims, costs, damages, and expenses, and reasonable attorney fees arising out of, directly or indirectly, any claim of personal injury or death associated with such unintended or unauthorized use, even if such claim alleges that ON Semiconductor was negligent regarding the design or manufacture of the part. ON Semiconductor is an Equal Opportunity/Affirmative Action Employer. This literature is subject to all applicable copyright laws and is not for resale in any manner.



FPF2C110BI07AS2

F2, Boost and Inverter module with Press-fit

General Description

Fairchild's Boost and H-Bridge module is designed for a power stage that needs more compact design. And the Press-fit technology provides simple and reliable mounting. This module is optimized for the application such as solar inverter where a high efficiency and robust design are needed.

Electrical Features

- Boost Stage
 - Dual Boost Topology
 - SiC Boost Diode
 - Low $R_{DS(ON)}$ Boost Switch
 - Low V_F and High Voltage Bypass Diode
- Inverter Stage
 - H-bridge Topology
 - High Speed IGBT and Fast Recovery FWD
- Integrated DC-capacitor for Boost and Inverter
- Temperature Sensor

Mechanical Features

- Compact size : F2 Package
- Press-fit Contact Technology
- Al_2O_3 Substrate with Low Thermal Resistance

Applications

- Solar Inverter

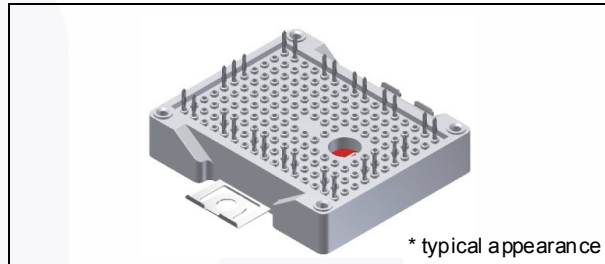

* typical appearance

Package Code: F2

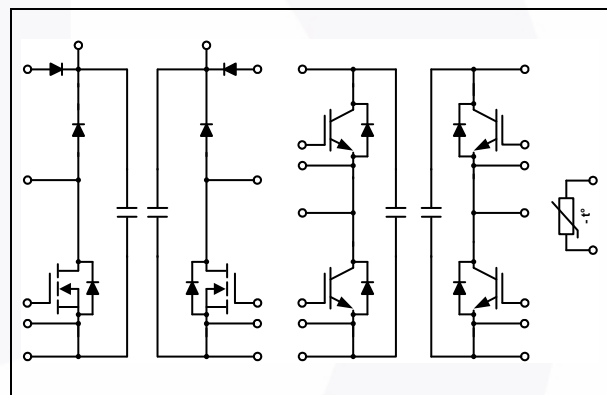

Internal Circuit Diagram

Package Marking and Ordering Information

Device	Device Marking	Package	Packing Type	Quantity / Tray
FPF2C110BI07AS2	FPF2C110BI07AS2	F2	Tray	14

FPF2C110BI07AS2 F2, Boost and Inverter module with Press-fit

Absolute Maximum Ratings $T_C = 25^\circ\text{C}$ unless otherwise noted.

Symbol	Description	Condition	Rating	Units
Bypass Diode (DA1, DA2)				
V_{RRM}	Peak Repetitive Reverse Voltage		1000	V
I_F	Continuous Forward Current	$T_C = 80^\circ\text{C}, T_{Jmax} = 175^\circ\text{C}$	50	A
I_{FSM}	Non-repetitive Peak Surge Current	60 Hz Single Half-Sine Wave	350	A
I^2t	Surge Current Integral Value		510	A^2s
P_D	Maximum Power Dissipation	$T_{Jmax} = 175^\circ\text{C}$	300	W
T_J	Operating Junction Temperature		- 40 to + 150	$^\circ\text{C}$
Boost Diode (DB1, DB2)				
V_{RRM}	Peak Repetitive Reverse Voltage		650	V
I_F	Continuous Forward Current	$T_C = 80^\circ\text{C}, T_{Jmax} = 175^\circ\text{C}$	10	A
I_{FSM}	Non-repetitive Peak Surge Current	60 Hz Single Half-Sine Wave	40	A
I^2t	Surge Current Integral Value		6.6	A^2s
P_D	Maximum Power Dissipation	$T_{Jmax} = 175^\circ\text{C}$	90	W
T_J	Operating Junction Temperature		- 40 to + 150	$^\circ\text{C}$
Boost MOSFET (M1, M2)				
V_{DSS}	Drain-Source Voltage		650	V
V_{GSS}	Gate-Source Voltage		± 20	V
I_D	Drain Current	$T_C = 25^\circ\text{C}, T_{Jmax} = 150^\circ\text{C}$	25	A
		$T_C = 80^\circ\text{C}, T_{Jmax} = 150^\circ\text{C}$	19	A
I_{DM}	Pulsed Drain Current	limited by T_{Jmax}	50	A
P_D	Maximum Power Dissipation	$T_{Jmax} = 150^\circ\text{C}$	199	W
T_J	Operating Junction Temperature		- 40 to + 150	$^\circ\text{C}$
H-bridge IGBT (QA, QB, QC, QD)				
V_{CES}	Collector-Emitter Voltage		650	V
V_{GES}	Gate-Emitter Voltage		± 20	V
I_C	Collector Current	$T_C = 80^\circ\text{C}, T_{Jmax} = 175^\circ\text{C}$	40	A
I_{CM}	Pulsed Collector Current	limited by T_{Jmax}	80	A
P_D	Maximum Power Dissipation	$T_{Jmax} = 175^\circ\text{C}$	158	W
T_J	Operating Junction Temperature		- 40 to + 150	$^\circ\text{C}$
H-bridge FWD (QAD, QBD, QCD, QDD)				
V_{RRM}	Peak Repetitive Reverse Voltage		650	V
I_F	Diode Forward Current	$T_C = 80^\circ\text{C}, T_{Jmax} = 175^\circ\text{C}$	30	A
I_{FM}	Pulsed Maximum Forward Currents	limited by T_{Jmax}	60	A
P_D	Maximum Power Dissipation	$T_{Jmax} = 175^\circ\text{C}$	109	W
T_J	Operating Junction Temperature		- 40 to + 150	$^\circ\text{C}$
DC Link Capacitor				
V_{MAX}	Maximum DC Voltage		1000	V
T_{OP}	Operating Temperature		- 55 to + 125	$^\circ\text{C}$

Absolute Maximum Ratings $T_C = 25^\circ\text{C}$ unless otherwise noted.

Symbol	Description	Condition	Rating	Units
Module				
T_{STG}	Storage Temperature		- 40 to + 125	$^\circ\text{C}$
V_{ISO}	Isolation Voltage	AC 1 min.	2500	V
Iso_Material	Internal Isolation Material		Al_2O_3	-
T_{MOUNT}	Mounting Torque ₍₁₎		2.4	N•m
Creepage	Terminal to Heat Sink		11.5	mm
	Terminal to Terminal		6.3	mm
Clearance	Terminal to Heat Sink		10.0	mm
	Terminal to Terminal		5.0	mm

Notes:

1. Recommendable value : 2.0 ~ 2.4 Nm (M4)

Electrical Characteristics $T_C = 25^\circ\text{C}$ unless otherwise noted. **Parantheses value is based on the discrete.**

Symbol	Parameter	Conditions	Min.	Typ.	Max.	Units	
Bypass Diode (DA1, DA2)							
V_F	Diode Forward Voltage	$I_F = 50\text{ A}$	-	1.37	1.7	V	
		$I_F = 50\text{ A}, T_C = 125^\circ\text{C}$	-	1.3	-	V	
I_R	Reverse Leakage Current	$V_R = 1000\text{ V}$	-	-	250	μA	
$R_{\theta JC}$	Thermal Resistance of Junction to Case	per Diode	-	-	0.49	$^\circ\text{C/W}$	
$R_{\theta CH}$	Thermal Resistance of Case to Heat sink	per Chip, $\lambda_{PCM} = 3.4\text{ W/mK}$	-	0.56	-	$^\circ\text{C/W}$	
Boost Diode (DB1, DB2)							
V_F	Diode Forward Voltage	$I_F = 10\text{ A}$	-	1.42	1.58	V	
		$I_F = 10\text{ A}, T_C = 125^\circ\text{C}$	-	1.61	-	V	
I_R	Reverse Leakage Current	$V_R = 650\text{ V}$	-	-	250	μA	
I_{rr}	Reverse Recovery Current	$V_R = 300\text{ V}, I_F = 10\text{ A},$ $di/dt = 1560\text{ A/us},$ $T_C = 25^\circ\text{C}$	-	6	-	A	
Q_C	Total Capacitive Charge		-	60	-	nC	
E_{rec}	Reverse Recovery Energy		-	7.5	-	μJ	
I_{rr}	Reverse Recovery Current	$V_R = 300\text{ V}, I_F = 10\text{ A},$ $di/dt = 1560\text{ A/us},$ $T_C = 125^\circ\text{C}$	-	6	-	A	
Q_C	Total Capacitive Charge		-	61	-	nC	
E_{rec}	Reverse Recovery Energy		-	7.5	-	μJ	
$R_{\theta JC}$	Thermal Resistance of Junction to Case	per Chip	-	-	1.63	$^\circ\text{C/W}$	
$R_{\theta CH}$	Thermal Resistance of Case to Heat sink	per Chip, $\lambda_{PCM} = 3.4\text{ W/mK}$	-	0.42	-	$^\circ\text{C/W}$	
Boost MOSFET (M1, M2)							
Off Characteristics							
V_{DSS}	Drain-Source Breakdown Voltage	$V_{GS} = 0\text{ V}, I_D = 1\text{ mA}$	650	-	-	V	
I_{DSS}	Drain Cut-off Current	$V_{DS} = V_{DSS}, V_{GS} = 0\text{ V}$	-	-	250	μA	
I_{GSS}	Gate-Source Leakage Current	$V_{GS} = V_{GSS}, V_{DS} = 0\text{ V}$	-	-	± 1	μA	
On Characteristics							
$V_{GS(th)}$	Gate-Source Threshold Voltage	$V_{GS} = V_{DS}, I_D = 250\mu\text{A}$	3.0	3.9	5.0	V	
$R_{DS(on)}$	Static Drain-Source On Resistance	$I_D = 17.5\text{ A}, V_{GS} = 10\text{ V}$	-	110	137	$\text{m}\Omega$	
V_{SD}	Drain-Source Diode Forward Voltage	$I_{SD} = 17.5\text{ A}, V_{GS} = 0\text{ V}$	-	1.07	1.37	V	
		$I_{SD} = 17.5\text{ A}, V_{GS} = 0\text{ V}, T_C = 125^\circ\text{C}$	-	0.93	-	V	
R_{LEAD}	Lead Resistance of Pin to Chip	per Chip	-	3.2	-	$\text{m}\Omega$	
Switching Characteristics							
$t_{d(on)}$	Turn-On Delay Time	$V_{CC} = 300\text{ V}$ $I_D = 17.5\text{ A}$ $V_{GS} = 10\text{ V}$ $R_G = 4.7\ \Omega$ Inductive Load $T_C = 25^\circ\text{C}$	-	27	-	ns	
t_r	Rise Time		-	5.0	-	ns	
$t_{d(off)}$	Turn-Off Delay Time		-	3.0	-	ns	
t_f	Fall Time		-	5.5	-	ns	
E_{ON}	Turn-On Switching Loss per Pulse		-	33	-	μJ	
E_{OFF}	Turn-Off Switching Loss per Pulse		-	20	-	μJ	
$t_{d(on)}$	Turn-On Delay Time		$V_{CC} = 300\text{ V}$ $I_D = 17.5\text{ A}$ $V_{GS} = 10\text{ V}$ $R_G = 4.7\ \Omega$ Inductive Load $T_C = 125^\circ\text{C}$	-	26	-	ns
t_r	Rise Time		-	5.3	-	ns	
$t_{d(off)}$	Turn-Off Delay Time		-	87	-	ns	
t_f	Fall Time		-	6.0	-	ns	
E_{ON}	Turn-On Switching Loss per Pulse	-	39	-	μJ		
E_{OFF}	Turn-Off Switching Loss per Pulse	-	21	-	μJ		
Q_g	Total Gate Charge	$V_{CC} = 300\text{ V}, I_{SD} = 17.5\text{ A}, V_{GS} = 10\text{ V}$	-	84	-	nC	
$R_{\theta JC}$	Thermal Resistance of Junction to Case	per Chip	-	-	0.63	$^\circ\text{C/W}$	
$R_{\theta CH}$	Thermal Resistance of Case to Heat sink	per Chip, $\lambda_{PCM} = 3.4\text{ W/mK}$	-	0.49	-	$^\circ\text{C/W}$	

Electrical Characteristics $T_C = 25\text{ }^\circ\text{C}$ unless otherwise noted. **Parantheses value is based on the discrete.**

Symbol	Parameter	Conditions	Min.	Typ.	Max.	Units	
H-Bridge IGBT (QA, QB, QC, QD)							
Off Characteristics							
BV_{CES}	Collector-Emitter Breakdown Voltage	$V_{GE} = 0\text{ V}, I_C = 1\text{ mA}$	650	-	-	V	
I_{CES}	Collector Cut-off Current	$V_{CE} = V_{CES}, V_{GE} = 0\text{ V}$	-	-	250	μA	
I_{GES}	Gate-Emitter Leakage Current	$V_{GE} = V_{GES}, V_{CE} = 0\text{ V}$	-	-	± 2	μA	
On Characteristics							
$V_{GE(th)}$	Gate-Emitter Threshold Voltage	$V_{GE} = V_{CE}, I_C = 40\text{ mA}$	3.0	5.2	6.1	V	
$V_{CE(sat)}$	Collector-Emitter Saturation Voltage	$I_C = 40\text{ A}, V_{GE} = 15\text{ V}$	-	1.6	2.3	V	
		$I_C = 40\text{ A}, V_{GE} = 15\text{ V}, T_C = 125\text{ }^\circ\text{C}$	-	1.8	-	V	
R_{LEAD}	Lead Resistance of Pin to Chip	per Chip	-	3.5	-	$\text{m}\Omega$	
Switching Characteristics (QB-QAD / QD-QCD)							
$t_{d(on)}$	Turn-On Delay Time	$V_{CC} = 300\text{ V}$ $I_C = 40\text{ A}$ $V_{GE} = 15\text{ V}$ $R_G = 15\text{ }\Omega$ Inductive Load $T_C = 25\text{ }^\circ\text{C}$	-	26	-	ns	
t_r	Rise Time		-	22	-	ns	
$t_{d(off)}$	Turn-Off Delay Time		-	125	-	ns	
t_f	Fall Time		-	14	-	ns	
E_{ON}	Turn-On Switching Loss per Pulse		-	0.45	-	mJ	
E_{OFF}	Turn-Off Switching Loss per Pulse		-	0.27	-	mJ	
$t_{d(on)}$	Turn-On Delay Time		$V_{CC} = 300\text{ V}$ $I_C = 40\text{ A}$ $V_{GE} = 15\text{ V}$ $R_G = 15\text{ }\Omega$ Inductive Load $T_C = 125\text{ }^\circ\text{C}$	-	24	-	ns
t_r	Rise Time			-	25	-	ns
$t_{d(off)}$	Turn-Off Delay Time			-	139	-	ns
t_f	Fall Time			-	13	-	ns
E_{ON}	Turn-On Switching Loss per Pulse	-		0.74	-	mJ	
E_{OFF}	Turn-Off Switching Loss per Pulse	-		0.35	-	mJ	
Q_g	Total Gate Charge	$V_{CC} = 300\text{ V}, I_C = 40\text{ A}, V_{GE} = 15\text{ V}$	-	60	-	nC	
$R_{\theta JC}$	Thermal Resistance of Junction to Case	per Chip	-	-	0.95	$^\circ\text{C/W}$	
$R_{\theta CH}$	Thermal Resistance of Case to Heat sink	per Chip, $\lambda_{PCM} = 3.4\text{ W/mK}$	-	0.64	-	$^\circ\text{C/W}$	
H-bridge FWD (QAD, QBD, QCD, QDD)							
V_F	Diode Forward Voltage	$I_F = 30\text{ A}$	-	2.45	3.2	V	
		$I_F = 30\text{ A}, T_C = 125\text{ }^\circ\text{C}$	-	2.15	-	V	
I_R	Reverse Leakage Current	$V_R = 650\text{ V}$	-	-	250	μA	
I_{rr}	Reverse Recovery Current	$V_R = 300\text{ V}, I_F = 30\text{ A},$ $di/dt = 1570\text{ A/us},$ $T_C = 25\text{ }^\circ\text{C}$	-	20.1	-	A	
t_{rr}	Reverse Recovery Time		-	30	-	ns	
E_{rec}	Reverse Recovery Energy		-	27	-	μJ	
I_{rr}	Reverse Recovery Current	$V_R = 300\text{ V}, I_F = 30\text{ A},$ $di/dt = 1135\text{ A/us},$ $T_C = 125\text{ }^\circ\text{C}$	-	23.1	-	A	
t_{rr}	Reverse Recovery Time		-	52	-	ns	
E_{rec}	Reverse Recovery Energy		-	73	-	μJ	
$R_{\theta JC}$	Thermal Resistance of Junction to Case	per Chip	-	-	1.38	$^\circ\text{C/W}$	
$R_{\theta CH}$	Thermal Resistance of Case to Heat sink	per Chip, $\lambda_{PCM} = 3.4\text{ W/mK}$	-	0.45	-	$^\circ\text{C/W}$	
DC link Capacitor							
C value	Capacitance Value		-	47	-	nF	
NTC (Thermistor)							
R_{NTC}	Rated Resistance	$T_C = 25\text{ }^\circ\text{C}$	-	22	-	$\text{k}\Omega$	
		$T_C = 100\text{ }^\circ\text{C}$	-	1.486	-	$\text{k}\Omega$	
	Tolerance	$T_C = 25\text{ }^\circ\text{C}$	-5	-	+5	%	
P_D	Power Dissipation	$T_C = 25\text{ }^\circ\text{C}$	-	-	20	mW	
B_{Value}	B-Constance	$B_{25/50}, \text{tol.}$	-	3950	-	K	
		$B_{25/100}$	-	3998	-	K	

Typical Performance Characteristics

Fig 1. Forward Voltage Drop
- Bypass Diode

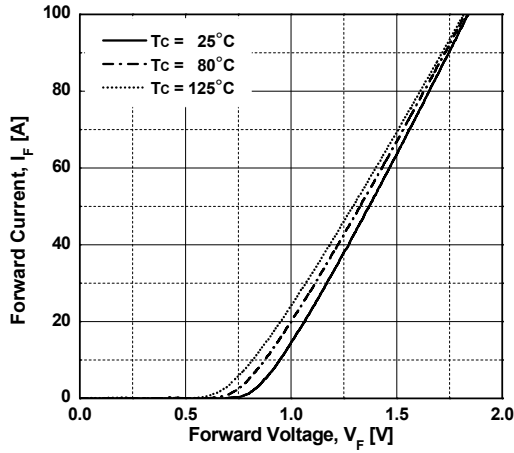

Fig 2. Transient Thermal Impedance
- Bypass Diode

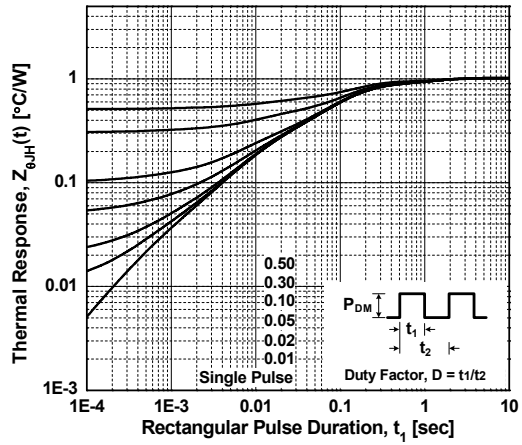

Fig 3. Forward Voltage Drop
- Boost Diode

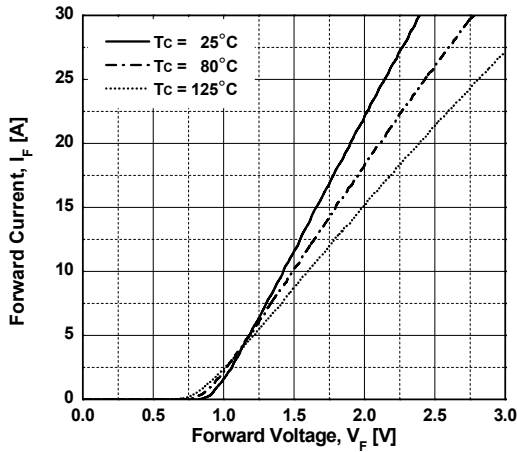

Fig 4. Transient Thermal Impedance
- Boost Diode

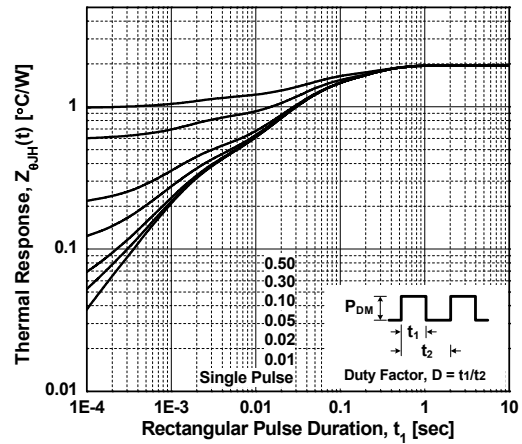

Fig 5. On-Region Characteristics
- Boost MOSFET

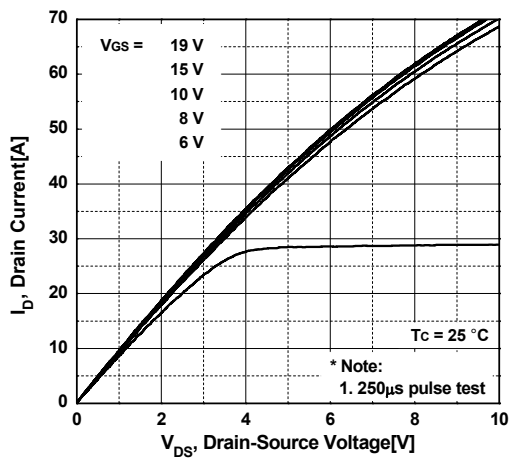
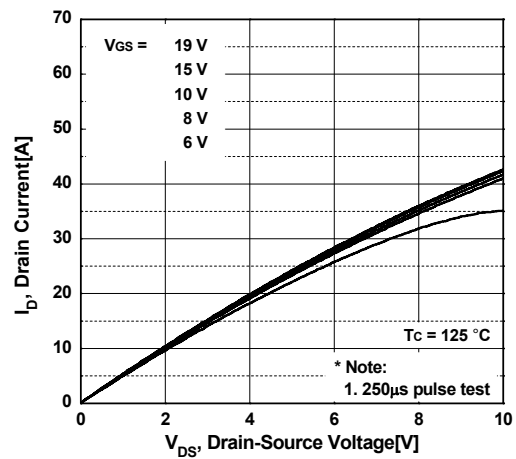

Fig 6. On-Region Characteristics
- Boost MOSFET



Typical Performance Characteristics

Fig 7. On-Resistance Variation vs. Temperature - Boost MOSFET

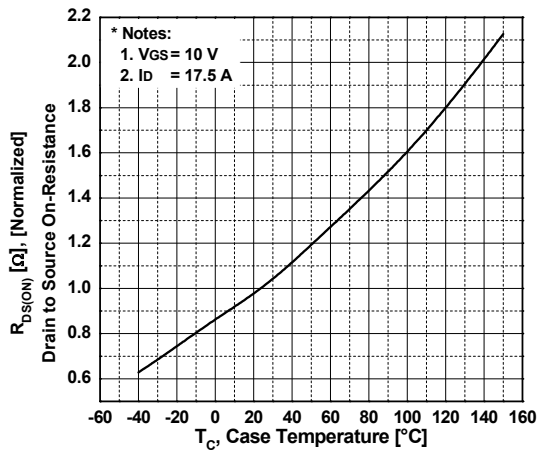

Fig 8. Switching Loss vs. Gate Resistor Values - Boost MOSFET

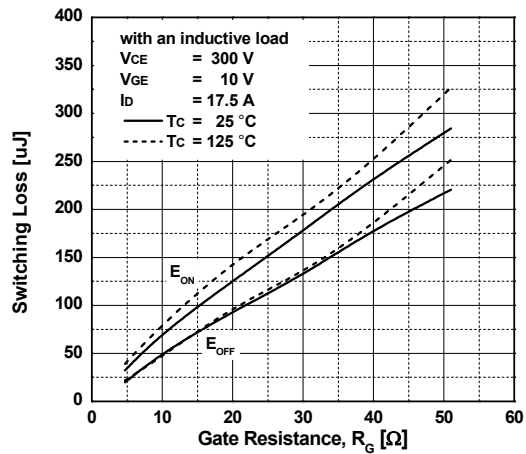

Fig 9. Switching Loss vs. Drain Current - Boost MOSFET

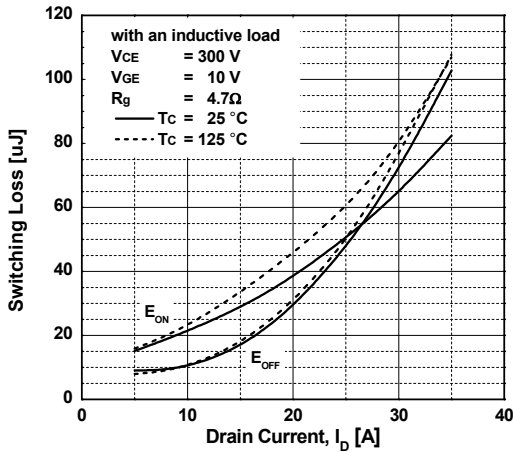

Fig 10. Body Diode Forward Voltage Variation vs. Source Current and Temperature - Boost MOSFET

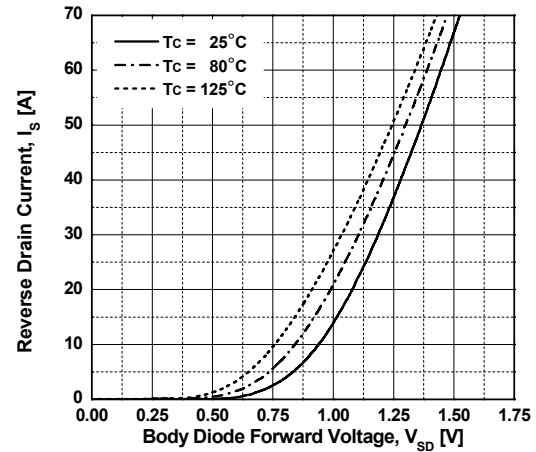

Fig 11. Transient Thermal Impedance - Boost MOSFET

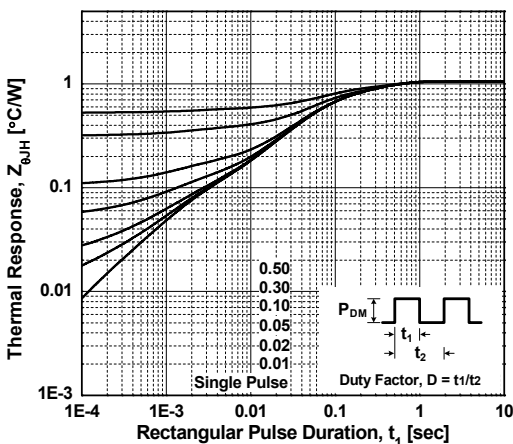
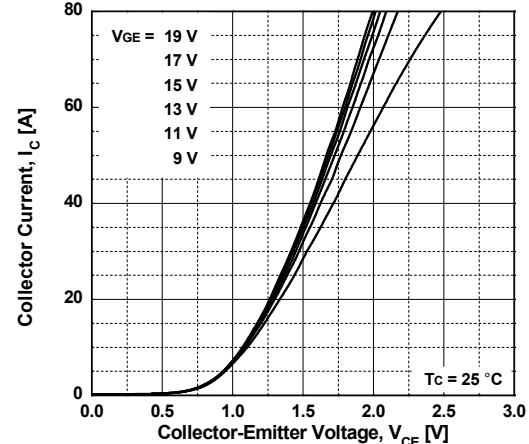

Fig 12. Output Characteristics - H-bridge IGBT



Typical Performance Characteristics

Fig 13. Output Characteristics
- H-bridge IGBT

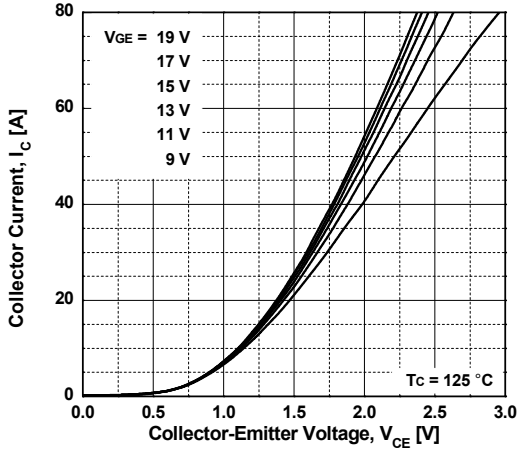

Fig 14. Saturation Voltage Characteristics
- H-bridge IGBT

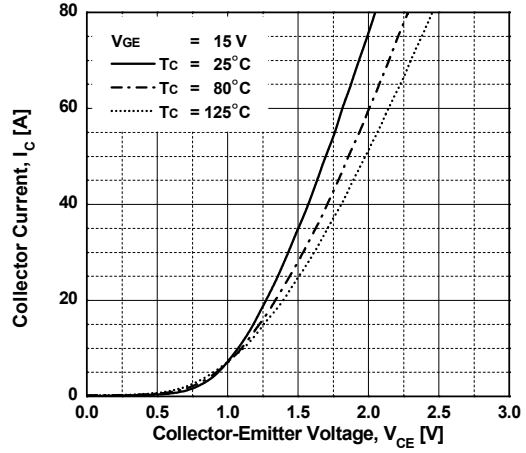

Fig 15. Switching Loss vs. Gate Resistor Values
- H-bridge IGBT

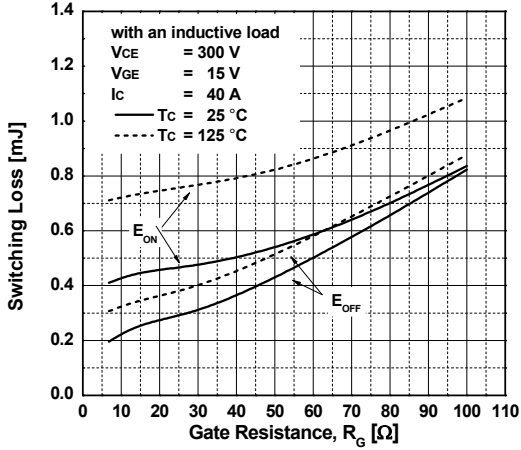

Fig 16. Switching Loss vs. Collector Current
- H-bridge IGBT

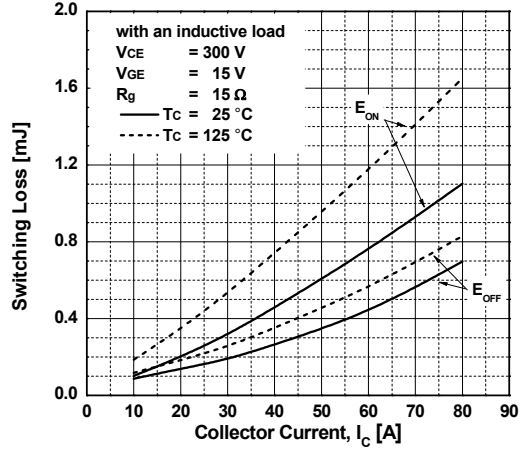

Fig 17. Transient Thermal Impedance
- H-bridge IGBT

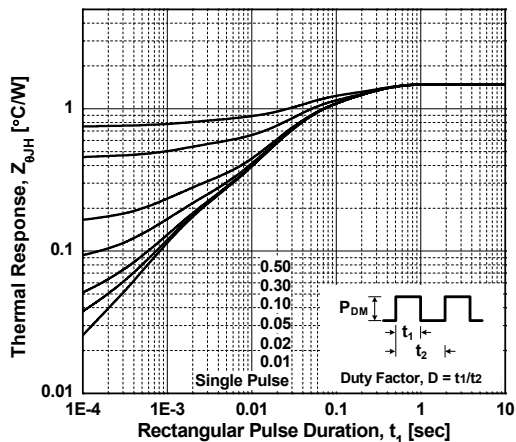
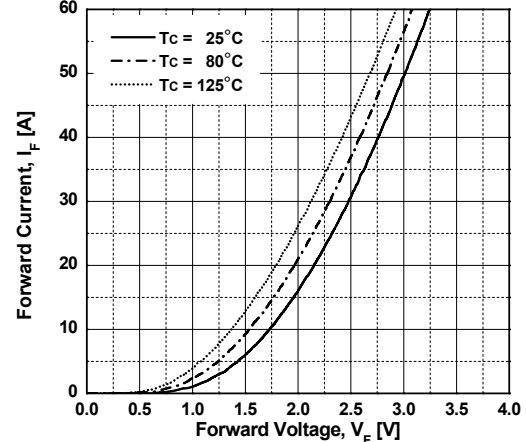

Fig 18. Forward Voltage Drop vs. Forward Current
- H-bridge FWD



Typical Performance Characteristics

Fig 19. Reverse Recovery Energy vs. Gate Resistor Values - H-bridge FWD

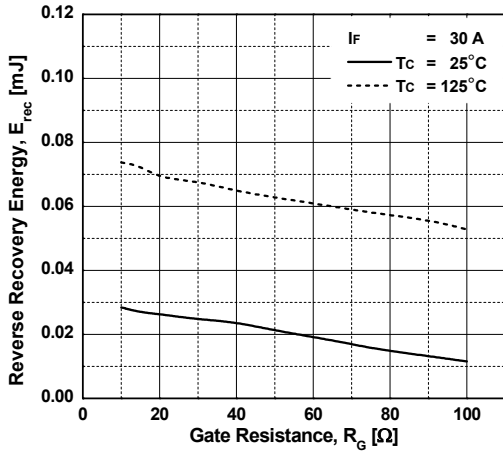

Fig 20. Reverse Recovery Energy vs. Forward Current - H-bridge FWD

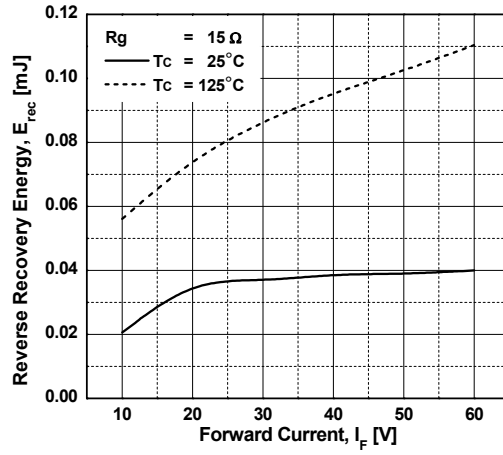
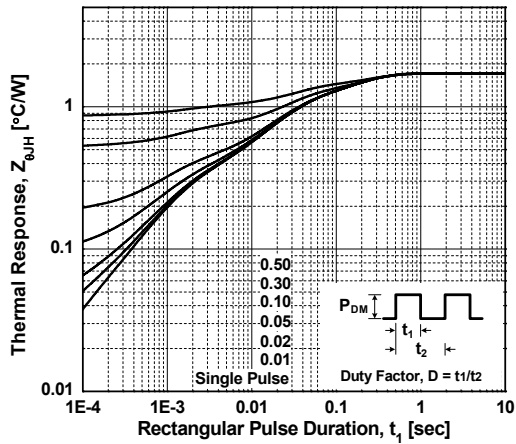
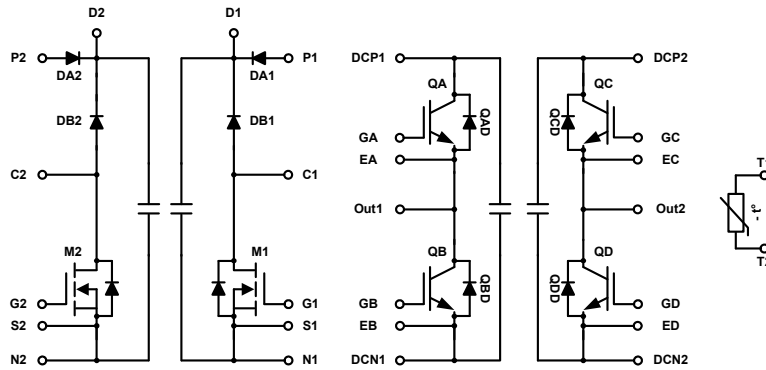

Fig 21. Transient Thermal Impedance - H-bridge FWD



Internal Circuit Diagram





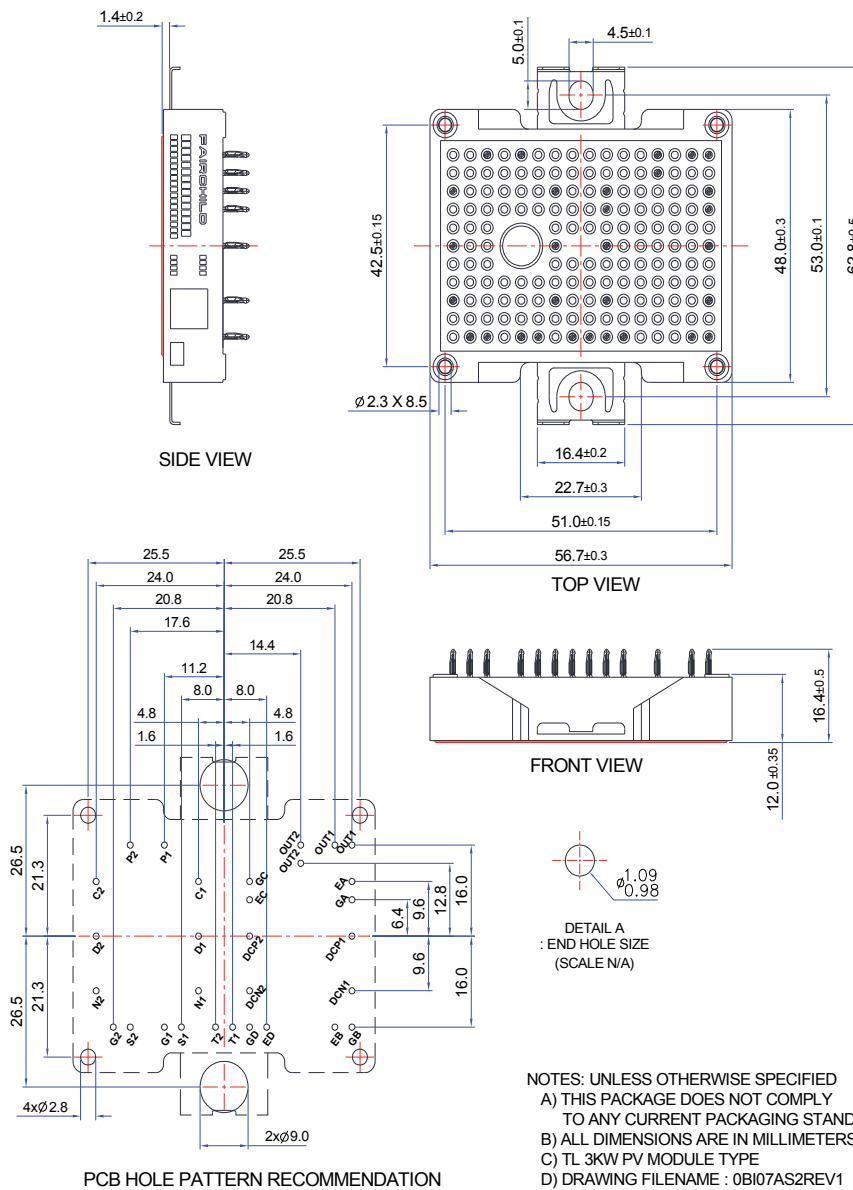

Package Outlines [mm]





TRADEMARKS

The following includes legends registered and unregistered trademarks and service marks, owned by Fairchild Semiconductor and/or its global subsidiaries, and is not intended to be an exhaustive list of all such trademarks.

- | | | | |
|--|--|---|---|
| AccuPower™ | F-PFS™ | OPTOPLANAR® |  SYSTEM GENERAL® |
| AttitudeEngine™ | FRFET® |  ® | TinyBoost® |
| Awinda® | Global Power Resource™ | | TinyBuck® |
| AX-CAP®* | GreenBridge™ | Power Supply WebDesigner™ | TinyCalc™ |
| BitSiC™ | Green FPS™ | PowerTrench® | TinyLogic® |
| Build it Now™ | Green FPS™ e-Series™ | PowerXS™ | TINYOPTO™ |
| CorePLUS™ | Gmax™ | Programmable Active Droop™ | TinyPower™ |
| CorePOWER™ | GTO™ | QFET® | TinyPWM™ |
| CROSSVOLT™ | IntelliMAX™ | QS™ | TinyWire™ |
| CTL™ | ISOPLANAR™ | Quiet Series™ | TranSiC™ |
| Current Transfer Logic™ | Making Small Speakers Sound Louder and Better™ | RapidConfigure™ | TriFault Detect™ |
| DEUXPEED® | MegaBuck™ |  ™ | TRUECURRENT®* |
| Dual Cool™ | MICROCOUPLER™ | Saving our world, 1mW/W/kW at a time™ | µSerDes™ |
| EcoSPARK® | MicroFET™ | SignalWise™ |  SerDes™ |
| EfficientMax™ | MicroPak™ | SmartMax™ | UHC® |
| ESBC™ | MicroPak2™ | SMART START™ | Ultra FRFET™ |
|  Fairchild® | MillerDrive™ | Solutions for Your Success™ | UniFET™ |
| Fairchild Semiconductor® | MotionMax™ | SPM® | VCX™ |
| FACT Quiet Series™ | MotionGrid® | STEALTH™ | VisualMax™ |
| FACT® | MTI® | SuperFET® | VoltagePlus™ |
| FastvCore™ | MTX® | SuperSOT™-3 | XS™ |
| FETBench™ | MVN® | SuperSOT™-6 | Xsens™ |
| FPS™ | mWSaver® | SuperSOT™-8 | 仙童® |
| | OptoHiT™ | SupreMOS® | |
| | OPTOLOGIC® | SyncFET™ | |
| | | Sync-Lock™ | |

* Trademarks of System General Corporation, used under license by Fairchild Semiconductor.

DISCLAIMER

FAIRCHILD SEMICONDUCTOR RESERVES THE RIGHT TO MAKE CHANGES WITHOUT FURTHER NOTICE TO ANY PRODUCTS HEREIN TO IMPROVE RELIABILITY, FUNCTION, OR DESIGN. TO OBTAIN THE LATEST, MOST UP-TO-DATE DATASHEET AND PRODUCT INFORMATION, VISIT OUR WEBSITE AT [HTTP://WWW.FAIRCHILDEMI.COM](http://www.fairchildsemi.com). FAIRCHILD DOES NOT ASSUME ANY LIABILITY ARISING OUT OF THE APPLICATION OR USE OF ANY PRODUCT OR CIRCUIT DESCRIBED HEREIN; NEITHER DOES IT CONVEY ANY LICENSE UNDER ITS PATENT RIGHTS, NOR THE RIGHTS OF OTHERS. THESE SPECIFICATIONS DO NOT EXPAND THE TERMS OF FAIRCHILD'S WORLDWIDE TERMS AND CONDITIONS, SPECIFICALLY THE WARRANTY THEREIN, WHICH COVERS THESE PRODUCTS.

AUTHORIZED USE

Unless otherwise specified in this data sheet, this product is a standard commercial product and is not intended for use in applications that require extraordinary levels of quality and reliability. This product may not be used in the following applications, unless specifically approved in writing by a Fairchild officer: (1) automotive or other transportation, (2) military/aerospace, (3) any safety critical application – including life critical medical equipment – where the failure of the Fairchild product reasonably would be expected to result in personal injury, death or property damage. Customer's use of this product is subject to agreement of this Authorized Use policy. In the event of an unauthorized use of Fairchild's product, Fairchild accepts no liability in the event of product failure. In other respects, this product shall be subject to Fairchild's Worldwide Terms and Conditions of Sale, unless a separate agreement has been signed by both Parties.

ANTI-COUNTERFEITING POLICY

Fairchild Semiconductor Corporation's Anti-Counterfeiting Policy. Fairchild's Anti-Counterfeiting Policy is also stated on our external website, www.fairchildsemi.com, under Terms of Use

Counterfeiting of semiconductor parts is a growing problem in the industry. All manufacturers of semiconductor products are experiencing counterfeiting of their parts. Customers who inadvertently purchase counterfeit parts experience many problems such as loss of brand reputation, substandard performance, failed applications, and increased cost of production and manufacturing delays. Fairchild is taking strong measures to protect ourselves and our customers from the proliferation of counterfeit parts. Fairchild strongly encourages customers to purchase Fairchild parts either directly from Fairchild or from Authorized Fairchild Distributors who are listed by country on our web page cited above. Products customers buy either from Fairchild directly or from Authorized Fairchild Distributors are genuine parts, have full traceability, meet Fairchild's quality standards for handling and storage and provide access to Fairchild's full range of up-to-date technical and product information. Fairchild and our Authorized Distributors will stand behind all warranties and will appropriately address any warranty issues that may arise. Fairchild will not provide any warranty coverage or other assistance for parts bought from Unauthorized Sources. Fairchild is committed to combat this global problem and encourage our customers to do their part in stopping this practice by buying direct or from authorized distributors.

PRODUCT STATUS DEFINITIONS

Definition of Terms

Datasheet Identification	Product Status	Definition
Advance Information	Formative / In Design	Datasheet contains the design specifications for product development. Specifications may change in any manner without notice.
Preliminary	First Production	Datasheet contains preliminary data; supplementary data will be published at a later date. Fairchild Semiconductor reserves the right to make changes at any time without notice to improve design.
No Identification Needed	Full Production	Datasheet contains final specifications. Fairchild Semiconductor reserves the right to make changes at any time without notice to improve the design.
Obsolete	Not In Production	Datasheet contains specifications on a product that is discontinued by Fairchild Semiconductor. The datasheet is for reference information only.

Rev. I77

ON Semiconductor and  are trademarks of Semiconductor Components Industries, LLC dba ON Semiconductor or its subsidiaries in the United States and/or other countries. ON Semiconductor owns the rights to a number of patents, trademarks, copyrights, trade secrets, and other intellectual property. A listing of ON Semiconductor's product/patent coverage may be accessed at www.onsemi.com/site/pdf/Patent-Marking.pdf. ON Semiconductor reserves the right to make changes without further notice to any products herein. ON Semiconductor makes no warranty, representation or guarantee regarding the suitability of its products for any particular purpose, nor does ON Semiconductor assume any liability arising out of the application or use of any product or circuit, and specifically disclaims any and all liability, including without limitation special, consequential or incidental damages. Buyer is responsible for its products and applications using ON Semiconductor products, including compliance with all laws, regulations and safety requirements or standards, regardless of any support or applications information provided by ON Semiconductor. "Typical" parameters which may be provided in ON Semiconductor data sheets and/or specifications can and do vary in different applications and actual performance may vary over time. All operating parameters, including "Typicals" must be validated for each customer application by customer's technical experts. ON Semiconductor does not convey any license under its patent rights nor the rights of others. ON Semiconductor products are not designed, intended, or authorized for use as a critical component in life support systems or any FDA Class 3 medical devices or medical devices with a same or similar classification in a foreign jurisdiction or any devices intended for implantation in the human body. Should Buyer purchase or use ON Semiconductor products for any such unintended or unauthorized application, Buyer shall indemnify and hold ON Semiconductor and its officers, employees, subsidiaries, affiliates, and distributors harmless against all claims, costs, damages, and expenses, and reasonable attorney fees arising out of, directly or indirectly, any claim of personal injury or death associated with such unintended or unauthorized use, even if such claim alleges that ON Semiconductor was negligent regarding the design or manufacture of the part. ON Semiconductor is an Equal Opportunity/Affirmative Action Employer. This literature is subject to all applicable copyright laws and is not for resale in any manner.

PUBLICATION ORDERING INFORMATION

LITERATURE FULFILLMENT:

Literature Distribution Center for ON Semiconductor
19521 E. 32nd Pkwy, Aurora, Colorado 80011 USA
Phone: 303-675-2175 or 800-344-3860 Toll Free USA/Canada
Fax: 303-675-2176 or 800-344-3867 Toll Free USA/Canada
Email: orderlit@onsemi.com

N. American Technical Support: 800-282-9855 Toll Free
USA/Canada
Europe, Middle East and Africa Technical Support:
Phone: 421 33 790 2910
Japan Customer Focus Center
Phone: 81-3-5817-1050

ON Semiconductor Website: www.onsemi.com
Order Literature: <http://www.onsemi.com/orderlit>
For additional information, please contact your local
Sales Representative