



**APPLICATION
MANUAL**

**Genesis™ NP and NPX
Series**



The logo for Genesis, featuring the word "genesis" in a bold, lowercase, sans-serif font. A red swoosh underline starts under the 'g' and loops around the 's'. A small "TM" trademark symbol is positioned to the upper right of the 's'.

Today's Genesis™ NP Series is the culmination of more than ten decades of battery manufacturing experience. High energy density, leak proof construction, excellent performance in either float or cyclic applications and long service life combine to make the Genesis NP Series the most reliable and versatile maintenance free rechargeable sealed lead acid batteries available.

Table of contents

Introduction	2
Technical Features	3
Applications	4
Battery Construction	4
General Specifications NP Series	5
Terminal Configurations	6
Battery Capacity Selection Charts	7
Discharge	7-9
Discharge Characteristics	
Over-Discharge (Deep Discharge)	
Storage, Self-Discharge, and Shelf Life	9
Self-Discharge	
Shelf Life	
Recharging Batteries in Storage	
Impedance	9-10
Temperature Characteristics	
Charging	10-13
Constant Current Charging	
Two Step Constant Voltage Charging	
Charging Voltage	
Initial Charge Current Limit	
Top Charging	
Temperature Compensation	
Charging Efficiency	
Solar Powered Charging	
Service Life	13
Cyclic Service Life	
Float Service Life	
Tips & Precautions	14
Glossary	14-15
Limited Warranty	16



Technical Features	Benefit
Construction	The construction and sealing techniques of the Genesis NP battery guarantee leakproof operation in any position with no adverse effect to capacity or service life.
Electrolyte Suspension System	All Genesis NP batteries utilize an electrolyte suspension system consisting of a high porosity, glass fiber material which in conjunction with plates, totally absorb and contain the electrolyte. No silica gels or any other contaminants are used.
Gas Generation	Genesis NP batteries incorporate a built-in design that controls gas generation and induces recombination of more than 99% of gases generated during float usage.
Maintenance Free Operation	There is no need to check specific gravity of the electrolyte or add water to Genesis NP batteries during float service life. In fact, there is no provision for this type of maintenance.
Low Pressure Valve Regulated System	All Genesis NP batteries are equipped with safety release valves, designed to operate between 2 and 5 psi and automatically reseal. Hence, there is never an excessive accumulation of gas within the battery.
Heavy Duty Grids	Heavy duty lead calcium tin alloy grids provide an extra margin of performance and service life in either float or cyclic applications, even after repeated over discharges.
Cyclic Service Life	More than 1000 discharge/recharge cycles can be realized from Genesis NP batteries, dependent on the average depth of discharge.
Float Service Life	Genesis NP Series batteries have an expected life span of 3 to 5 years in float service applications.
Self Discharge - Shelf Life	The self discharge rate of the Genesis NP series at room temperature is approximately 3% of rated capacity per month.
Operating Temperature	Genesis NP Batteries may be operated over a broad range of ambient temperatures.
Deep Discharge Recovery	Genesis NP batteries recover their capacities even after repeated deep discharges.

Applications

A partial list of common applications include:

Float Service

- Burglar and Fire Alarm
- Office Machines
- Cash Registers
- Solar Power Devices
- Telecommunications
- Uninterrupted Power Supply (UPS) Equipment
- Emergency Lighting
- Computers

Cyclic Service

- Audio and Video Equipment
- Portable Lights
- Electric Wheelchairs
- Test Equipment
- Geophysical Equipment

Float/Cyclic Service

- Medical Equipment
- Communications
- Cellular Telephones

Genesis NP Battery Construction

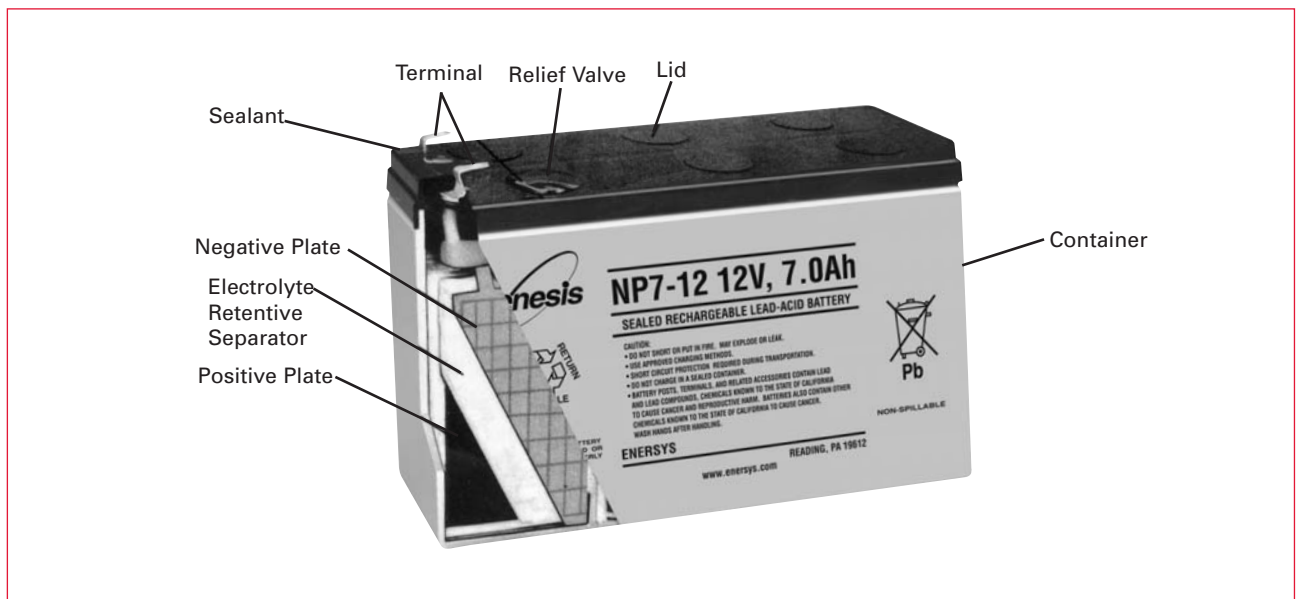

General Specifications NP Series

GENESIS NPH SERIES

Type	FR Type*	Volts	Nominal Capacity (10 hr rate - Ah)	Length		Width		Overall Height Incl. Terminals		Weight		Layout	Terminals
				mm.	(in.)	mm	(in.)	mm.	(in.)	kgs.	(lbs.)		
NPH2-12	NPH2-12FR	12	2.0	68.0	2.68	51.0	2.01	88.0	3.46	0.84	1.85	2	A
NPH3.2-12	NPH3.2-12FR		3.2	134.0	5.28	67.0	2.64	64.0	2.52	1.40	3.09	3	A

GENESIS NP SERIES

Type	FR Type*	Volts	Nominal Capacity (20 hr rate - Ah)	Length		Width		Overall Height Incl. Terminals		Weight		Layout	Terminals
				mm.	(in.)	mm	(in.)	mm.	(in.)	kgs.	(lbs.)		
NP1.2-6	NP1.2-6FR	6	1.2	97.0	3.82	25.0	0.98	54.5	2.15	0.30	0.66	1	A
NP2.8-6	NP2.8-6FR		2.8	67.0	2.64	34.0	1.34	105.0	4.13	0.59	1.30	5	A/D
NP3-6	-		3.0	134.0	5.28	34.0	1.33	64.0	2.52	0.65	1.43	1	A
NP4-6	-		4.0	70.0	2.76	47.0	1.85	105.5	4.15	0.85	1.87	5	A
NP4.5-6	-		4.5	70.0	2.76	47.0	1.85	107.0	4.21	0.87	1.92	5	A
NP5-6	NP5-6FR		5.0	70.0	2.76	47.0	1.85	107.0	4.21	0.93	2.05	5	A
NP7-6	NP7-6FR		7.0	151.0	5.95	64.0	1.33	97.5	3.84	1.35	2.98	1	A/D
NP8.5-6	-		8.5	98.0	3.86	56.0	2.21	118.0	4.65	1.60	3.53	9	A
NP10-6	NP10-6FR		10.0	151.0	5.95	50.0	1.97	97.5	3.84	2.00	4.41	1	A/D
NP12-6	NP12-6FR		12.0	151.0	5.95	50.0	1.97	101.0	3.98	2.07	4.56	1	A/D
NP0.8-12	NP0.8-12FR**	12	0.8	96.0	3.78	25.0	0.98	61.5	2.42	0.35	0.77	7	I/L
NP1.2-12	-		1.2	97.0	3.82	48.0	1.89	54.5	2.15	0.57	1.25	3	A
NP2-12	-		2.0	150.0	5.91	20.0	0.79	89.0	3.50	0.70	1.54	8	B
NP2-12-C	-		2.3	182.0	7.17	23.5	0.90	61.0	2.40	0.73	1.61	6	TU
-	NP2.3-12FR		2.3	178.0	7.01	34.0	1.34	64.0	2.52	0.94	2.07	1	A
-	NP2.6-12FR		2.6	134.0	5.28	67.0	2.64	64.0	2.52	1.12	2.47	3	A
NP2.9-12	NP2.9-12FR		2.9	132.0	5.20	33.0	1.30	104.0	4.09	1.16	0.56	1	A/D
NP3-12	NP3-12FR		3.0	132.0	5.20	33.0	1.30	104.5	4.11	1.20	2.65	1	A/D
NP3.4-12	NP3.4-12FR		3.4	134.0	5.28	67.0	2.64	67.0	2.64	1.37	3.02	3	A/D
NP4-12	NP4-12FR		4.0	90.0	3.54	70.0	2.76	106.0	4.17	1.70	3.74	1	A/D
NP5-12	NP5-12FR		5.0	90.0	3.54	70.0	2.76	106.0	4.17	2.00	4.41	1	A/D
NP7-12	NP7-12FR		7.0	151.0	5.94	65.0	2.56	97.5	3.84	2.65	6.17	4	A/D
NP12-12	NP12-12FR		12.0	151.0	5.94	98.0	3.86	97.5	3.84	4.00	8.82	4	D
NP18-12B	NP18-12BFR		17.2	181.0	7.13	76.2	2.99	167.0	6.57	6.20	13.64	2	E
NP24-12	NP24-12FR		24.0	166.0	6.54	175.0	6.89	125.0	4.92	8.65	19.05	2	C
NP33-12	NP33-12FR		32.9	195.3	7.69	132.6	5.22	155.2'	6.11'	10.90	24.00	1	M
-	NP38-12B		38.0	197.0	7.74	165.0	6.50	175.0	6.89	13.80	30.40	2	J
-	NP38-12R		38.0	197.0	7.74	165.0	6.50	175.0	6.89	13.80	30.40	2	K
NP55-12	NP55-12FR		56.3	250.4	9.86	139.1	5.48	207.0'	8.15'	18.70	41.10	1	M
NP65-12	NP65-12FR		65.0	350.0	13.78	166.0	6.54	174.0	6.85	22.80	50.20	2	G
NP75-12	NP75-12FR	77.5	281.6	11.09	169.2	6.66	207.0'	8.15'	24.90	54.70	1	M	
NP90-12	NP90-12FR	90.0	304.0	11.97	168.0	6.61	229.0	9.12	30.50	67.24	1	G	
NP100-12	NP100-12FR	91.6	330.9	13.03	169.2	6.66	207.0'	8.15'	29.80	65.70	1	M	
NP120-12	NP120-12FR	120.0	407.0	16.02	173.0	6.81	234.5	9.23	41.30	91.05	1	G	
NP150-12	NP150-12FR	150.0	483.0	19.02	170.0	6.69	241.0	9.49	46.80	103.17	1	G	
NP200-12	NP200-12FR	200.0	520.0	20.47	260.0	10.24	240.0	9.45	74.00	163.10	3	G	

DATASAFE NPX SERIES

Type	FR Type*	Volts	W/Cell to 1.67 End Voltage (15 Min Rate)	Length		Width		Overall Height Incl. Terminals		Weight		Layout	Terminals
				mm.	(in.)	mm	(in.)	mm.	(in.)	kgs.	(lbs.)		
NPX-50	NPX-50FR	6	50W/Cell	151.0	5.95	50.0	1.97	97.5	3.84	2.00	4.41	1	A/D
NPX-25	NPX-25FR		23W/Cell	90.0	3.54	70.0	2.75	106.0	4.17	2.00	4.41	1	D
NPX-35	NPX-35FR		35W/Cell	151.0	5.94	65.0	2.56	97.5	3.84	2.67	6.24	4	A/D
NPX-80	NPX-80FR		80W/Cell	181.0	7.13	76.2	2.99	167.0	6.57	6.60	14.50	2	E
-	NPX-100B		95W/Cell	166.0	6.54	125.0	4.92	175.0	6.89	9.30	20.80	2	J
-	NPX-100R		95W/Cell	166.0	6.54	125.0	4.92	175.0	6.89	9.30	20.80	2	K
-	NPX-150B		150W/Cell	197.0	7.76	165.0	6.50	175.0	6.89	15.50	34.10	2	J
-	NPX-150R		150W/Cell	197.0	7.76	165.0	6.50	175.0	6.89	15.50	34.10	2	K

FOOTNOTES:

* FR: UL94-VO, Flame Retardant Case and Cover (Oxygen index: 30)

† Height is to top cover. Overall height, including terminal is dependent on terminal configuration.

** FR: UL94-V2, Flame Retardant Case and Cover (Oxygen index: 30)

Recognized by UL File No. MH16464

Range Summary

• LAYOUT

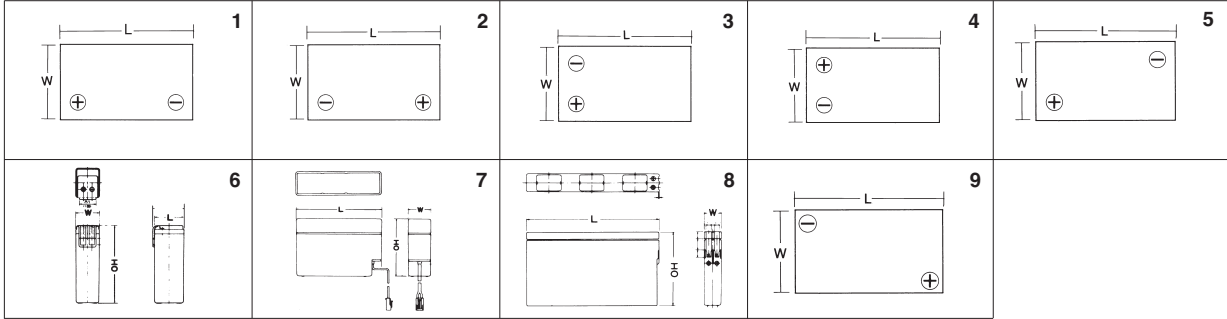

• TERMINAL

<p>Faston tab: 187 A</p> <table border="1"> <thead> <tr> <th colspan="2">INCH = MM</th> </tr> </thead> <tbody> <tr><td>.250</td><td>6.35</td></tr> <tr><td>.185</td><td>4.70</td></tr> <tr><td>.124</td><td>3.15</td></tr> <tr><td>.098</td><td>2.50</td></tr> <tr><td>.059</td><td>1.50</td></tr> <tr><td>.031</td><td>0.80</td></tr> <tr><td>.020</td><td>0.50</td></tr> <tr><td>.004</td><td>0.10</td></tr> </tbody> </table>	INCH = MM		.250	6.35	.185	4.70	.124	3.15	.098	2.50	.059	1.50	.031	0.80	.020	0.50	.004	0.10	<p>Faston tab: 187 B</p> <table border="1"> <thead> <tr> <th colspan="2">INCH = MM</th> </tr> </thead> <tbody> <tr><td>0.472</td><td>12.00</td></tr> <tr><td>0.250</td><td>6.35</td></tr> <tr><td>0.236</td><td>6.00</td></tr> <tr><td>0.185</td><td>4.70</td></tr> <tr><td>0.079</td><td>2.00</td></tr> <tr><td>0.020</td><td>0.50</td></tr> </tbody> </table>	INCH = MM		0.472	12.00	0.250	6.35	0.236	6.00	0.185	4.70	0.079	2.00	0.020	0.50	<p>Faston tab: 250 C</p> <table border="1"> <thead> <tr> <th colspan="2">INCH = MM</th> </tr> </thead> <tbody> <tr><td>.250</td><td>6.35</td></tr> <tr><td>.124</td><td>3.15</td></tr> <tr><td>.098</td><td>2.50</td></tr> <tr><td>.059</td><td>1.50</td></tr> <tr><td>.031</td><td>0.80</td></tr> <tr><td>.020</td><td>0.50</td></tr> </tbody> </table>	INCH = MM		.250	6.35	.124	3.15	.098	2.50	.059	1.50	.031	0.80	.020	0.50	<p>Faston tab: 250 D</p> <table border="1"> <thead> <tr> <th colspan="2">INCH = MM</th> </tr> </thead> <tbody> <tr><td>.310</td><td>7.90</td></tr> <tr><td>.250</td><td>6.35</td></tr> <tr><td>.16</td><td>4.0</td></tr> <tr><td>.031</td><td>0.8</td></tr> <tr><td>.020</td><td>0.5</td></tr> </tbody> </table>	INCH = MM		.310	7.90	.250	6.35	.16	4.0	.031	0.8	.020	0.5
INCH = MM																																																													
.250	6.35																																																												
.185	4.70																																																												
.124	3.15																																																												
.098	2.50																																																												
.059	1.50																																																												
.031	0.80																																																												
.020	0.50																																																												
.004	0.10																																																												
INCH = MM																																																													
0.472	12.00																																																												
0.250	6.35																																																												
0.236	6.00																																																												
0.185	4.70																																																												
0.079	2.00																																																												
0.020	0.50																																																												
INCH = MM																																																													
.250	6.35																																																												
.124	3.15																																																												
.098	2.50																																																												
.059	1.50																																																												
.031	0.80																																																												
.020	0.50																																																												
INCH = MM																																																													
.310	7.90																																																												
.250	6.35																																																												
.16	4.0																																																												
.031	0.8																																																												
.020	0.5																																																												
<p>Bolt fastened terminal E</p> <table border="1"> <thead> <tr> <th colspan="2">INCH = MM</th> </tr> </thead> <tbody> <tr><td>.472</td><td>12.00</td></tr> <tr><td>.453</td><td>11.50</td></tr> <tr><td>.433</td><td>11.00</td></tr> <tr><td>.216</td><td>5.50</td></tr> <tr><td>.079</td><td>2.00</td></tr> </tbody> </table>	INCH = MM		.472	12.00	.453	11.50	.433	11.00	.216	5.50	.079	2.00	<p>Bolt fastened terminal G</p> <table border="1"> <thead> <tr> <th colspan="2">INCH = MM</th> </tr> </thead> <tbody> <tr><td>0.24</td><td>6</td></tr> <tr><td>0.27</td><td>7</td></tr> <tr><td>0.37</td><td>9.5</td></tr> <tr><td>0.71</td><td>18</td></tr> <tr><td>0.768</td><td>19.5</td></tr> </tbody> </table>	INCH = MM		0.24	6	0.27	7	0.37	9.5	0.71	18	0.768	19.5	<p>JST No. VHR-2N I</p> <p>WIRE AWG \approx 20 UL 1007</p> <p>JST VHR-2N (TERMINAL)</p> <p>JST SVH-21T-P1.1</p>	<p>Bolt fastened terminal J</p> <p>(Lug) TERMINAL (inches)</p>																																		
INCH = MM																																																													
.472	12.00																																																												
.453	11.50																																																												
.433	11.00																																																												
.216	5.50																																																												
.079	2.00																																																												
INCH = MM																																																													
0.24	6																																																												
0.27	7																																																												
0.37	9.5																																																												
0.71	18																																																												
0.768	19.5																																																												
<p>Threaded Receptacle K</p> <p>UNF#10-32</p>	<p>Tyco. 1-480318-0 L</p>	<p>Terminal height above cover</p> <table border="1"> <thead> <tr> <th>Terminal Type</th> <th>NP33-12 mm</th> <th>ins</th> <th>NP55/75/100-12 mm</th> <th>ins</th> </tr> </thead> <tbody> <tr><td>B</td><td>5.1</td><td>0.20</td><td>3.3</td><td>0.13</td></tr> <tr><td>NB</td><td>22.8</td><td>0.90</td><td>21.1</td><td>0.83</td></tr> <tr><td>MJ</td><td>28.4</td><td>1.12</td><td>26.9</td><td>1.06</td></tr> <tr><td>AP</td><td>22.8</td><td>0.90</td><td>21.1</td><td>0.83</td></tr> <tr><td>MG</td><td>38.1</td><td>1.50</td><td>36.3</td><td>1.43</td></tr> <tr><td>U</td><td>22.8</td><td>0.90</td><td>21.1</td><td>0.83</td></tr> </tbody> </table> <p>Note: Dimensions are in inches (mm) Tolerances are \pm 0.04 in. (\pm1mm) and \pm 0.08 in. (\pm 2mm) for height dimensions.</p>		Terminal Type	NP33-12 mm	ins	NP55/75/100-12 mm	ins	B	5.1	0.20	3.3	0.13	NB	22.8	0.90	21.1	0.83	MJ	28.4	1.12	26.9	1.06	AP	22.8	0.90	21.1	0.83	MG	38.1	1.50	36.3	1.43	U	22.8	0.90	21.1	0.83																							
Terminal Type	NP33-12 mm	ins	NP55/75/100-12 mm	ins																																																									
B	5.1	0.20	3.3	0.13																																																									
NB	22.8	0.90	21.1	0.83																																																									
MJ	28.4	1.12	26.9	1.06																																																									
AP	22.8	0.90	21.1	0.83																																																									
MG	38.1	1.50	36.3	1.43																																																									
U	22.8	0.90	21.1	0.83																																																									
<p>U Positive Terminal</p>	<p>MG Positive</p>	<p>Automotive Type AP Positive</p>	<p>NB Terminal</p>																																																										
<p>U Negative Terminal</p>	<p>MG Negative</p>	<p>Automotive Type AP Negative</p>	<p>B Terminal</p>																																																										

Charging

- Standby use: Apply constant voltage charging at 2.275 volts per cell (or 2.25–2.30VPC).
- Cyclic use: Apply constant voltage charging at 2.40-2.50 VPC. Initial charging current should be set at less than 0.25CA.
- Top charge: Product in storage (ambient temperature 25°C/77°F) requires a top charge every six months. Apply constant voltage at 2.40 volts per cell, initial charging current should be set at less than 0.1CA for 15 to 20 hours.

Discharge

- Stop operation when voltage has reached the minimum permissible voltage. Recharge immediately.
- Do not operate at 6CA or more current continuously.

Storage

- Always store battery in a fully charged condition.
- If battery is to be stored for a long period, apply a recovery top-charge every 6 months.
- Store batteries in a dry and cool location.

Temperature

- Keep within ambient temperatures of -15°C to $+50^{\circ}\text{C}$ for both charging and discharging.

Incorporating battery into equipment

- Encase battery in a well ventilated compartment.
- Avoid installing battery near heated units such as a transformer.
- House the battery in the lowest section of the equipment enclosure or rack to prevent unnecessary battery temperature rise.

Others

- Avoid terminal short circuit.
- DO NOT expose to open flame.
- Avoid setting batteries in environments which can cause direct contact to gasoline, paint thinner, organic solvents, synthetic resins, oil, etc.

Battery Capacity Selection

Figures 1 and 2 may be used to determine battery size (expressed in Ampere Hours of capacity), for a specific application. To determine the capacity of the battery, establish the discharge current for the length of discharge time required. The point where the current and time lines intersect is the minimum capacity battery needed for the application. It is recommended you refer to Figures 3, 13, & 17 before making your final decision.

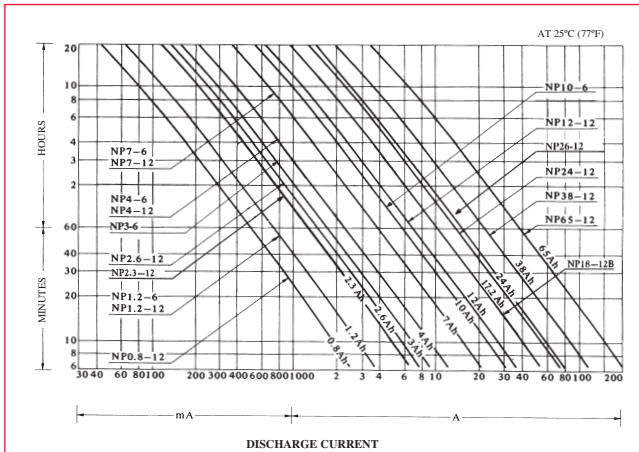

Figure 1. 20-Hour Rate Capacity Selection Chart

NPH Series Characteristics Curves

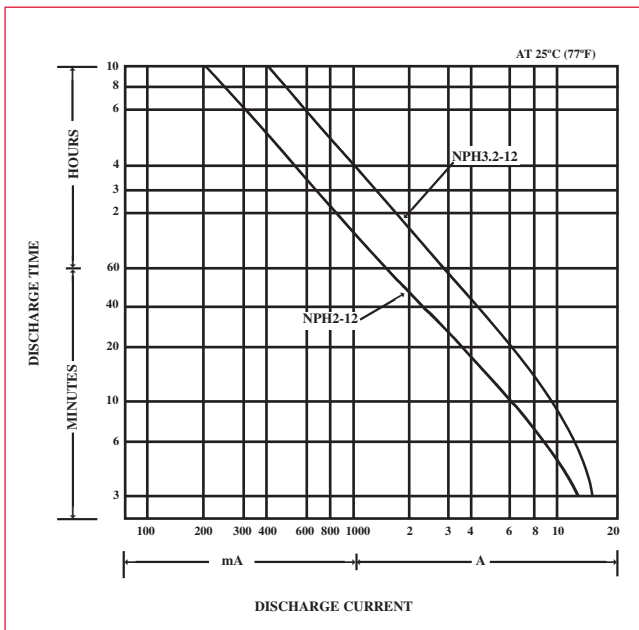

Figure 2. Capacity Selection Chart Genesis NPH Series

Discharge

Discharge Characteristics

The curves shown in Figures 1, 2, 3, & 4 and the discharge rates shown in Tables 1, 2, & 3 illustrate the typical discharge characteristics of Genesis NP and Genesis NPH batteries at an ambient temperature of 25°C (77°F). The symbol "C" expresses the nominal capacity of the Genesis NP battery, measured at a 20 hour discharge rate and the Genesis NPH at a 10 hour discharge rate. Please refer to General Specifications to determine the nominal capacity rating of the specific model.

The industry standard for designating the nominal capacity of a sealed lead acid battery involves a discharge test for a given number of hours to a final pre-set end voltage. The average current value multiplied by the hours of discharge time determines the capacity rating of that particular battery. Since manufacturers vary in their rating standards, it is always a good practice to question the rating standard.

Tables 1 and 2 show how the rated nominal capacity decreases when the discharge load is higher than the 20 hour rate. These tables should be consulted when selecting a battery for a high discharge application.

The discharge rates depicted in Table 2.5 reference watts per cell of the DataSafe NPX series of batteries. These batteries are designed for Uninterruptible Power Supply (UPS) applications where high rate discharge performance (under 30 minutes) is typical. To determine the battery kilowatt rating required for a UPS system, refer to the following formula: $KVA \text{ rating of UPS} \times \text{Power Factor (Pf)} \div \text{inverter efficiency} = \text{Total Battery Kilowatts (KWB)}$.

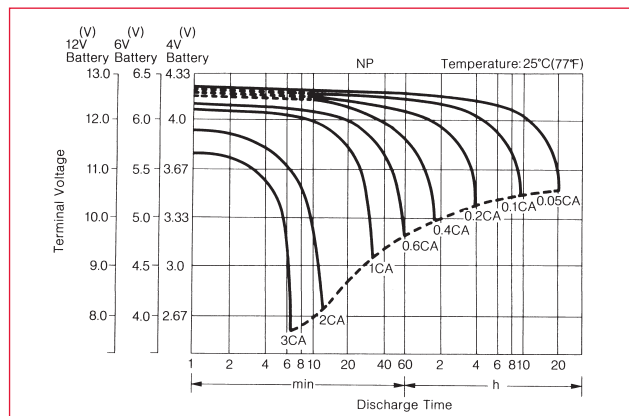

Figure 3. Discharge Characteristic Curves: Genesis NP Batteries

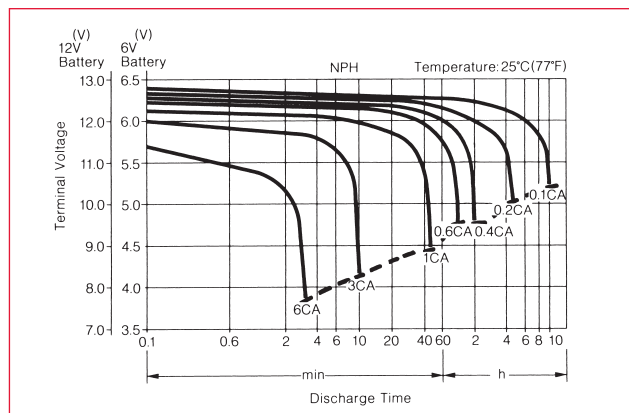

Figure 4. Discharge Characteristic Curves: Genesis NPH Batteries

Table 1. Discharge Current at Stipulated Discharge Rates

20 Hr. Capacity	Discharge Current							
	0.05C	0.1C	0.2C	0.4C	0.6C	1C	2C	3C
0.8 A	0.04 A	0.08 A	0.16 A	0.32 A	0.48 A	0.8 A	1.6 A	2.4 A
1.2	0.06	0.12	0.24	0.48	0.72	1.2	2.4	3.6
2.0	0.10	0.20	0.40	0.80	1.20	2.0	4.0	6.0
2.3	0.12	0.23	0.46	0.92	1.38	2.3	4.6	6.9
2.6	0.13	0.26	0.52	1.04	1.56	2.6	5.2	7.8
3.0	0.15	0.30	0.60	1.20	1.80	3.0	6.0	9.0
4.0	0.20	0.40	0.80	1.60	2.40	4.0	8.0	12.0
5.0	0.25	0.50	1.00	2.00	3.00	5.0	10.0	30.0
7.0	0.35	0.70	1.40	2.80	4.20	7.0	14.0	21.0
10.0	0.50	1.00	2.00	4.00	6.00	10.0	20.0	30.0
12.0	0.60	1.20	2.40	4.80	7.20	12.0	24.0	36.0
17.2	0.86	1.72	3.44	6.88	10.32	17.2	34.4	51.6
24.0	1.20	2.40	4.80	9.60	14.40	24.0	48.0	72.0
26.0	1.30	2.60	5.20	10.40	15.60	26.0	52.0	78.0
38.0	1.90	3.80	7.60	15.20	22.80	38.0	76.0	114.0
65.0	3.25	6.50	13.00	26.00	39.00	65.0	130.0	195.0

Table 2. Discharge Current at Stipulated Discharge Rates (NPH)

10 Hr. Capacity	Discharge Current							
	0.01C	0.2C	0.4C	0.6C	0.8C	1C	2C	3C
2.0	0.20	0.40	0.80	1.20	1.40	2.00	4.00	6.00
2.3	0.23	0.46	0.92	1.38	1.50	2.30	4.60	6.90
3.2	0.32	0.64	1.28	1.90	2.54	3.20	6.40	9.60

Table 2.5 NPX Watts Per Cell to 1.67 End Voltage

	5 MIN	10 MIN	15 MIN	20 MIN
NPX-25	47	31	23	18
NPX-50	94	60	50	38
NPX-35	66	45	35	29
NPX-80	155	104	80	65
NPX-100	185	125	95	75
NPX-150	285	200	150	120

Table 3. Discharge Capacity at Various Discharge Rates

20 Hr. Capacity	Discharge Capacity				
	20 Hr.	10 Hr.	5 Hr.	3 Hr.	1 Hr.
	0.05CA to 1.75 V/C	0.093CA to 1.75 V/C	0.17CA to 1.70 V/C	0.25CA to 1.67 V/C	0.60CA to 1.55 V/C
0.8 Ah	0.8 Ah	0.74 Ah	0.68 Ah	0.62 Ah	0.48 Ah
1.2	1.2	1.1	1.0	0.9	0.7
2.0	2.0	1.9	1.7	1.6	1.2
2.3	2.3	2.2	2.0	1.8	1.4
2.6	2.6	2.4	2.2	2.0	1.6
3.0	3.0	2.8	2.6	2.3	1.8
4.0	4.0	3.7	3.4	3.1	2.4
5.0	5.0	4.6	4.3	3.8	3.0
7.0	7.0	6.5	6.0	5.4	4.2
10.0	10.0	9.3	8.5	7.7	6.0
12.0	12.0	11.2	10.2	9.2	7.2
17.2	17.2	16.0	14.6	13.2	10.3
24.0	24.0	22.3	20.4	18.5	14.4
26.0	26.0	24.2	22.1	20.0	15.6
38.0	38.0	35.0	32.3	29.3	22.8
65.0	65.0	60.5	55.2	50.1	39.0

Over-Discharge (Deep Discharge)

The dotted line in Figures 3 & 4 indicates the lowest recommended voltage under load, or cut-off voltage, at various discharge rates. In general, lead acid batteries are damaged in terms of capacity and service life if discharged below the recommended cut-off voltages. It is generally recognized that all lead calcium alloy grid batteries are subject to over-discharge damage. For example, if a lead acid battery were discharged to zero and left in either open or closed circuit for a long period of time, severe sulfation and shorting would occur, thus raising the internal resistance abnormally high. In such an extreme case, the battery may not accept a charge.

Genesis NP Series batteries however, have been designed to withstand such occasional over discharge. While it is not recommended, Genesis NP batteries can recover their full capacity under normal charging conditions, even when they have been subjected to extreme over discharge.

Final discharge voltage is as shown in Table 4.

Table 4. Final Discharge Voltage

Discharge Current	Final Discharge (V/Cell)
0.1 C or below, or Intermittent discharge	1.75
0.1 7C or current close to it	1.70
0.26C or current close to it	1.67
0.6C or current close to it	1.60
From 0.6C to 3C	1.50
Current in excess of 3C	1.30

When considering discharge currents exceeding 3C, consult with an EnerSys Application Engineer.

Self-Discharge

The self-discharge rate of Genesis NP batteries is approximately 3% per month when the storage temperature is maintained at 20°C (68°F). The self-discharge rate will vary with storage temperature and the remaining capacity.

Storage, Self-Discharge and Shelf Life

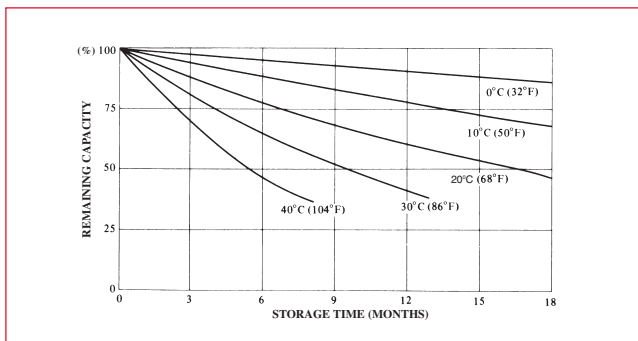

Figure 5. Self Discharge Characteristics

Shelf Life

In general, when lead acid batteries of any type are stored in a discharged condition for extended periods of time, lead sulfate is formed on the negative plates of the batteries. This phenomenon is referred to as “sulfation”. Since the lead sulfate acts as an insulator, it has a direct detrimental effect on charge acceptance. The more advanced the sulfation, the

lower the charge acceptance. “Brief storage”, i.e., a few days, at temperatures higher than the ranges recommended, will have no adverse effect on storage time or service life. However, if such use continues for more than one month, the storage time must be determined according to the new ambient temperature.

Table 5 below shows the normal storage time or shelf life at various ambient temperatures.

Table 5. Shelf Life at Various Temperatures

Temperature	Shelf Life
0°C (32°F) to 20°C (68°F)	12 months
21°C (70°F) to 30°C (86°F)	9 months
31°C (88°F) to 40°C (104°F)	5 months
41°C (106°F) to 50°C (122°F)	2.5 months

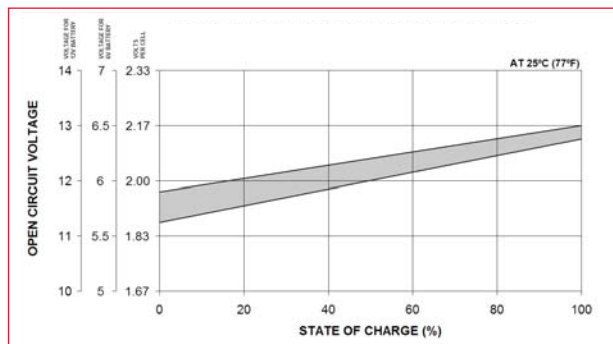

Figure 6. Open Circuit Voltage vs. State of Charge

Recharging Stored Batteries

In general, to optimize performance and service life, it is recommended that Genesis NP batteries which are to be stored for extended periods of time be given a supplementary charge, commonly referred to as a “refresh charge”, periodically. Please refer to the recommendations listed under REFRESH CHARGING.

Impedance

The internal resistance (impedance) of a battery is lowest when the battery is in a fully charged state. The internal resistance increases gradually during discharge, Figure 7 shows the internal resistance of an Genesis NP battery measured through a 1,000 Hz AC bridge.

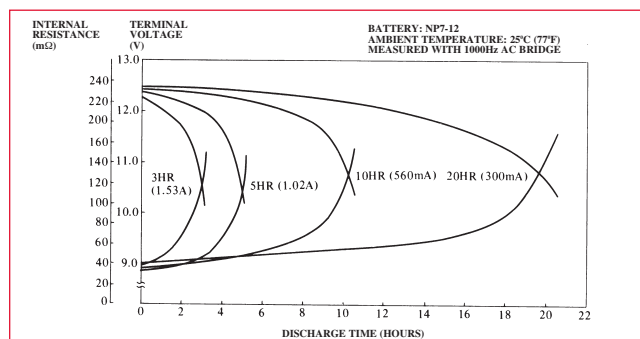

Figure 7. Internal Resistance of NP Battery

■ Temperature characteristics

At higher temperatures, the electrical capacity that can be taken out of a battery increases. At lower temperatures, the electrical capacity that can be taken out of a battery decreases. Figure 8 shows the temperature effects in relation to battery capacity.

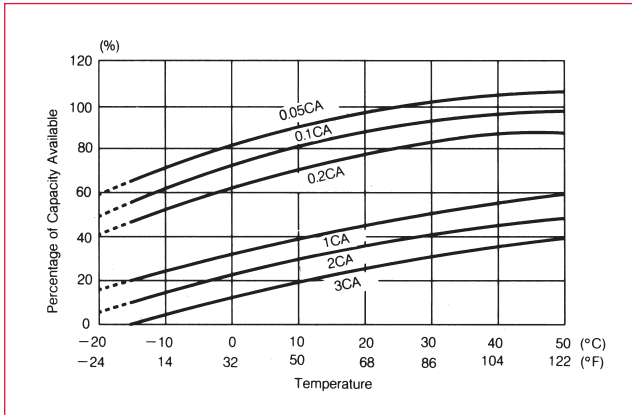

Figure 8. Temperature Effects in Relation to Battery Capacity

Charging

Proper charging is one of the most important factors to consider when using maintenance free sealed lead-acid batteries. Battery performance and service life will be directly effected by the efficiency of the charger selected. The two charging methods are:

- Constant Current Charging
- Two Step Constant-Voltage Charging

■ Constant-Current Charging

This charging method is not often utilized for sealed lead-acid batteries, but is an effective method for charging a multiple number of batteries at one time, and/or as an equalizing charge to correct variances in capacity between batteries in a group. Caution should be exercised when charging by constant current. If the charge is continued at the same rate for an extended period of time after the battery has reached a fully charged state, severe overcharge may occur, resulting in damage to the battery. Figure 9 shows the characteristics of an Genesis NP battery under continuous overcharge conditions.

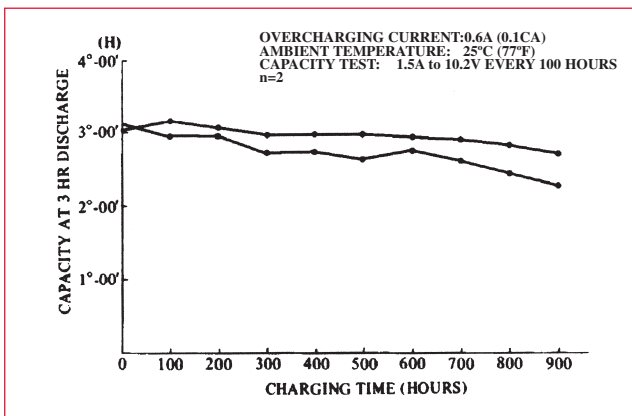

Figure 9. Overcharge Characteristics of NP7-12 Under Continuous Overcharge

■ Two Step Constant Voltage Charging

Two step constant voltage charging is the recommended method for charging a sealed lead-acid battery in a short period of time, and maintaining the battery in a fully charged standby or float condition, thereafter. Figure 10 illustrates the characteristics of a two step constant voltage charger.

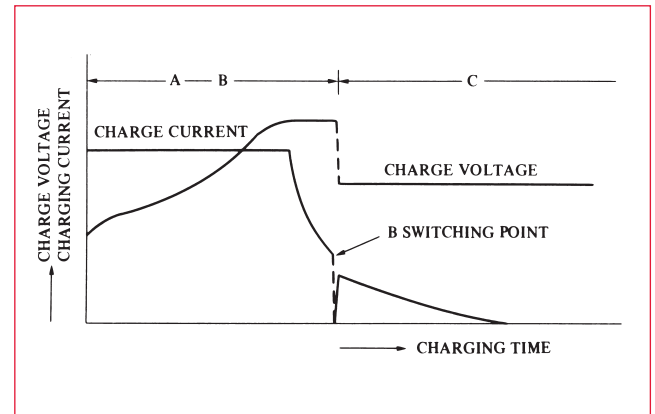

Figure 10. Charging Characteristics of a Two Step Constant-Voltage Charger

The characteristics shown in Figure 10 are those of a constant voltage, constant current charger. In the initial charging stage, the battery is charged by constant current. The charging voltage rises, as the charge continues, until it reaches 2.45 volts per cell, at which point the charging mode automatically changes to constant voltage charging. During the constant current charging stage (A-B) the charging current which has decreased to point B is sensed, and the charging voltage is switched to the float level of 2.3 volts per cell from the recovery level of 2.45 volts per cell. The switch to constant voltage trickle charging occurs after the battery has recovered approximately 80% of the rated capacity over a given period of time. This charging method is one of the most efficient. The recharge time is minimized during the initial charging stage while the battery is protected from overcharge by the system switching over to float charge at the switching point B.

■ Charging Voltage

The charging voltage should be regulated according to the type of service in which the battery will be used. Generally, the following voltages are used at 25°C (77°F).

For standby (float) use 2.25 to 2.30 volts per cell
 For cyclic use 2.40 to 2.50 volts per cell

In a constant voltage charging system, a large amount of current will flow during the initial stage of charging, and decreases as the charging progresses. When charging at 2.30 volts per cell, charging current at the final stage of charging will drop to as little as 0.002CA.

Charging voltage should be regulated in relation to the ambient temperature. When the temperature is higher, the charging voltage should be lower. When the temperature is lower, the charging voltage should be higher. For specific recommendations, please refer to the section on Temperature Compensation. Similarly, capacity (measured in ampere-hours) attainable over time will vary in direct relation to the ambient temperature. The capacity in a given period of time will be larger at higher temperatures, and smaller at lower temperatures.

■ Initial Charge Current Limit

A discharged battery will accept a high charging current at the initial stage of charging. High charging current can cause abnormal internal heating which may damage the battery. Therefore, it is recommended that the charging current be normally limited to 0.25CA. However, in standby use, Genesis NP batteries are designed so that even if the charging current is higher than the recommended limit, they will not accept more than 2CA, and the charging current will be reduced to a relatively small value in a very brief period of time. Therefore, in standby use, no current limit is required. Figure 11 shows current acceptance in Genesis NP batteries charged at constant voltage, with no current limit.

When designing a charger, it is recommended that a current limiting function be provided in the charger in order to prevent charger failure due to overheating of the transformer, or other damage resulting from mishandling, i.e., short circuiting or reversing polarity.

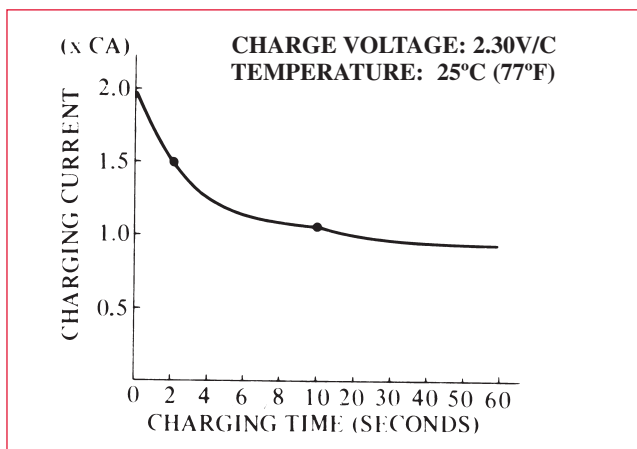

Figure 11. Constant-Voltage Charge Characteristics with no Current Limit

■ Refresh Charging

Since any battery loses capacity through self-discharge, it is recommended that a “refresh charging” be applied to any battery which has been stored for a long period of time, prior to putting the battery into service. Excepting conditions in which storage temperature have been abnormally high, refresh charging is recommended within the following parameters:

Battery Age	Refresh Charging Recommendations
Within 6 months after manufacture	4 to 6 hours at constant current of 0.1CA, or 15 to 20 hours at constant voltage of 2.40 volts per cell.
Within 12 months after manufacture	8 to 10 hours at constant current of 0.1CA, or 20 to 24 hours at constant voltage of 2.40 volts per cell.

Genesis NP batteries must not be allowed to self-discharge to less than 2.08 volts per cell on open circuit. To recover deeply discharged batteries, charge them for 24 hours using a constant voltage charger set at 2.40 volts per cell at 25°C (77°F) with a maximum current of 0.15C. A 16-hour recovery charge is possible by setting the charge voltage at 2.45 volts per cell and a maximum current of 0.25C.

In view of the above, consideration should be given to the fact that if the charging method used is constant voltage in which the charger employs current sensing for either state of charge indication or for reducing voltage (a two step charger), during the initial stage of charging an over-discharged battery the charger may give a false “full charge” indication, or may initiate charge at a float voltage.

■ Temperature Compensation

As temperature rises, electrochemical activity in a battery increases. Similarly, as temperature falls, electrochemical activity decreases. Therefore, conversely, as temperature rises, charging voltage should be reduced to prevent overcharge, and increased as temperature falls to avoid undercharge. In general, to assure optimum service life, use of a temperature compensated charger is recommended. The recommended compensation factor for Genesis NP batteries is -3mV/°C/Cell (stand by) and -4mV/°C/Cell (cyclic use). The standard center point for temperature compensation is 25°C (77°F). Figure 12 shows the relationship between temperatures and charging voltages in both cyclic and standby applications.

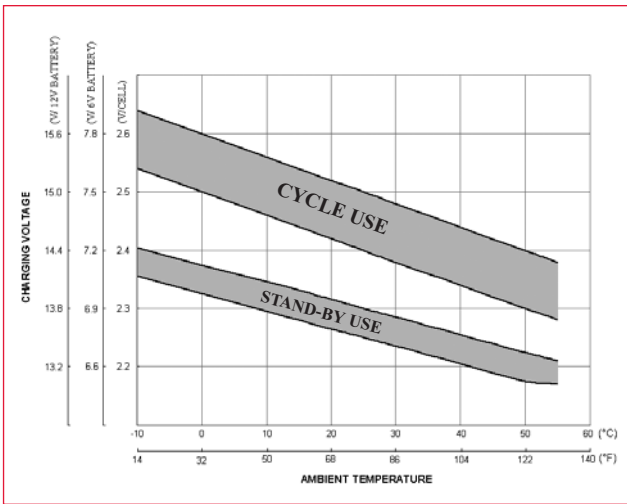

Figure 12. Relationship Between Charging Voltage and Temperature

In actual use in indoor applications (5°C to 40°C or 41°F to 104°F), it is not necessary to provide the charger with a temperature compensation function, but it is desirable to set the voltage at the value shown in Figure 12 which corresponds most closely to the average ambient temperature of the battery during service.

When designing a charger equipped with temperature compensation, the temperature sensor must sense only the temperature of the battery. Therefore, consideration should be given to isolating the battery and temperature sensor from other heat generating components of a system.

■ Charging Efficiency

The charging efficiency (η) of a battery is expressed by the following formula:

$$\eta = \frac{\text{AH Discharged After Charged}}{\text{AH Delivered To The Battery During Charge}}$$

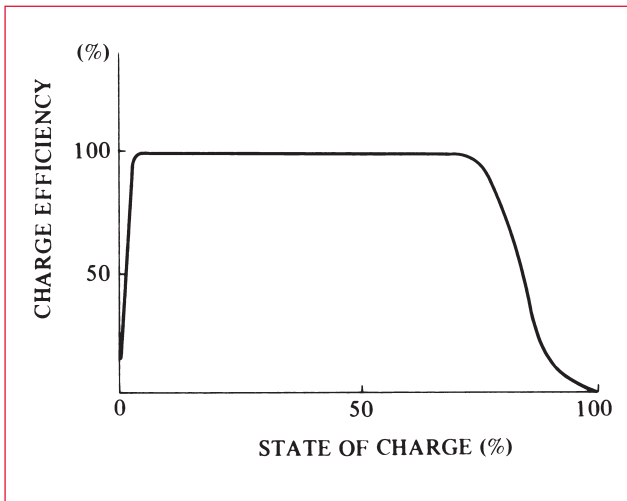

Figure 13. Charging Efficiency vs. State of Charge

The charging efficiency varies depending upon the state of charge of the battery, temperature, and charging rate. Figure 13 illustrates the concept of the state of charge and charging efficiency. As shown in Figure 14, Genesis NP batteries exhibit very high charging efficiency, even when charged at low charging rates. It is interesting to note that the charging efficiency of Genesis NP sealed lead-acid batteries is superior to that of other batteries at relatively low charge rates.

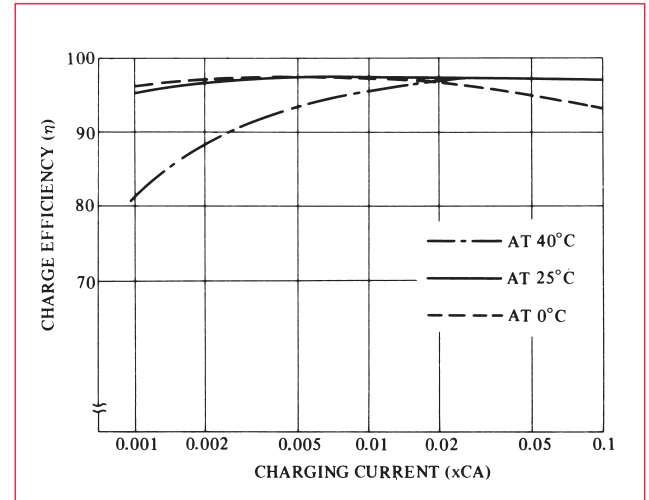

Figure 14. Charging Efficiency

■ Solar Powered Chargers

A battery is an indispensable component of any solar powered system designed for demand-energy use. Since solar cells have inherent constant voltage characteristics, Genesis NP batteries can be charged directly from the solar array using a simple diode regulated circuit as shown in Figure 15.

In designing a solar system, consideration should be given to the fact that, in addition to normal periods of darkness, weather conditions may be such that solar energy is limited, or virtually unavailable for long periods of time. In extreme cases, a system may have to operate for 10 to 20 days with little or no power available for charging. Therefore, when selecting the correct battery for a solar application, the capacity should be determined based upon maximum load conditions for the maximum period of time the system may be expected to be without adequate solar input.

In many instances the battery capacity will be 10 to 50 times greater than the maximum output of the solar panels. Under these circumstances, the maximum output of the solar array should be dedicated to charging the battery with no load-sharing or intervening control devices of any kind.

Naturally, in cases where the output of the solar array exceeds the capacity of the battery, and weather conditions are such that the potential for overcharging the battery exists, appropriate regulated charging circuitry between the solar panels and the battery is recommended.

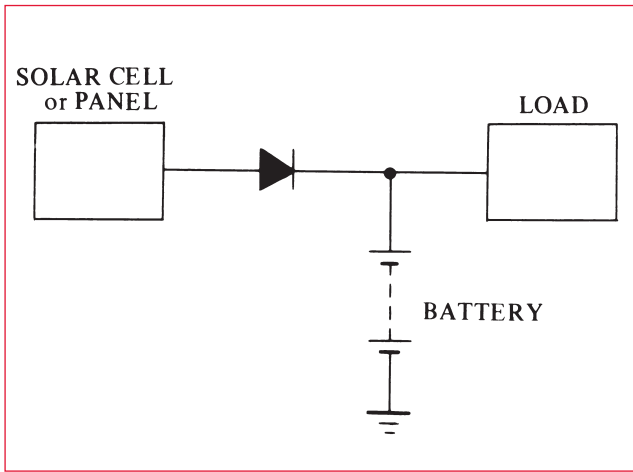

Figure 15. Block Diagram of a Solar System

Remote site, or other outdoor applications for solar systems is commonplace. When designing a solar system for this class of application, a great deal of consideration must be given to environmental conditions. For example, enclosures which may be used to house batteries and other equipment may be subject to extremely high internal temperatures when exposed to direct sunlight. Under those conditions, insulating the enclosure and/or treating the surface of the enclosure with a highly reflective, heat resistive material is recommended. In general, when designing a solar system, consultation with the solar panel manufacturer and battery manufacturer is recommended.

Expected Service Life of Genesis NP Batteries

Cyclic Service Life

There are a number of factors that will effect the length of cyclic service of a battery. The most significant are ambient operating temperature, discharge rate, depth of discharge, and the manner in which the battery is recharged. Generally speaking, the most important factor is depth of discharge. Figure 16 illustrates the effects of depth of discharge on cyclic life.

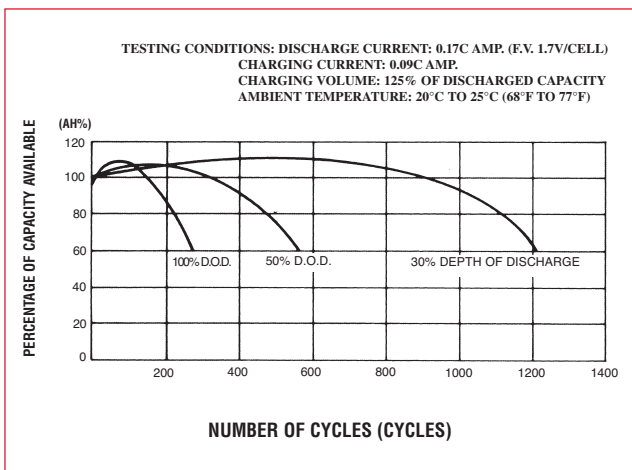

Figure 16. Cyclic Service Life in Relation to Depth of Discharge Genesis NP Series

The relationship between the number of cycles which can be

expected, and the depth of discharge is readily apparent. In relation to a specified discharge rate, if the application requires a longer cyclic life than is obtainable by selecting the battery capacity according common practice, select a battery with larger capacity. Thus, at the specified discharge rate over the specified time, the depth of discharge will be shallower and cyclic service life will be longer.

Float Service Life

Genesis NP batteries are designed to operate in standby (float) service for approximately 5 years, based upon a normal service condition in which float charge voltage is maintained between 2.25 and 2.30 volts per cell in an ambient temperature of approximately 25°C (77°F).

Figure 17 shows the float service life characteristics of Genesis NP batteries when discharged once every three (3) months to 100% depth of discharge.

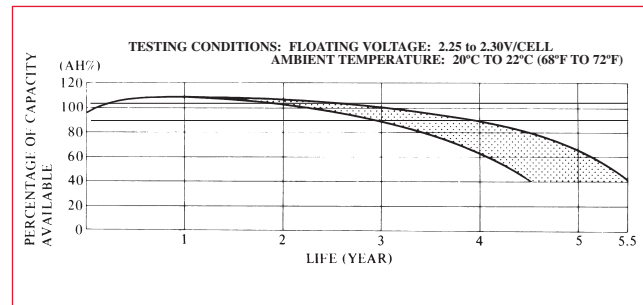

Figure 17. Float Service Life

In normal float service, where charging voltage is maintained 2.25 to 2.30 volts per cell, the gases generated inside and Genesis NP battery are continually recombined, and return to the water content of the electrolyte. Therefore, electrical capacity is not lost due to "drying up" of the electrolyte. Actually, through the gradual and very slow corrosion of the electrodes, the battery will eventually lose capacity and come to the end of service life. It should be noted that the corrosive process will be accelerated by high ambient operating temperatures and/or high charging voltage. When designing a float service system, always consider the following:

LENGTH OF SERVICE LIFE WILL BE DIRECTLY EFFECTED BY THE NUMBER OF DISCHARGE CYCLES, DEPTH OF DISCHARGE, AMBIENT TEMPERATURE, AND CHARGING VOLTAGE.

Tips and Precautions

Genesis NP Series batteries are truly efficient maintenance free electro-chemical systems and are designed to provide years of trouble free service. Their performance and service life can be greatly maximized by observing the following guidelines.

- Heat kills batteries. Avoid installation and/or operation in close proximity to heat sources of any kind. While the operating temperature range is -15°C to 50°C, and ideal service life will be realized when the battery is operated in an ambient temperature of 20°C (for cyclic service applications, a range of 5°C to 35°C is recommended).
- If the battery is to be installed in an air or water tight container, ventilation must be provided. Batteries may generate ignitable gases which must not be contained. Because of this, batteries should not be installed near spark producing equipment.
- Avoid installing the battery in an atmosphere where organic solvents or adhesives may be present. Do not clean the battery with oils, thinners or similar substances. Use water only. The case and cover of the battery is ABS plastic resin which may suffer damage from these chemicals.
- Soldering to the battery terminals is NOT recommended. If soldering is unavoidable, it must be accomplished within 3 seconds, using a maximum 100 watt soldering iron.
- If installed in a heavy vibration or shock application, the battery must be securely fastened with shock absorbing materials.
- Provide free air space between batteries when more than two are grouped together. The recommended distance is 0.2" to 0.4" (5mm to 10mm).
- Always wear insulated gloves when handling batteries; especially when series and parallel connecting groups of batteries.
- When batteries are connected together in a series-parallel arrangement, the inter-connecting cables must be of equal length and resistance to insure equalization of the load.
- For maximum life expectancy, the R.M.S. ripple current should be regulated to no more than 0.1C (10% of battery's rating).
- Do not crush, incinerate or dismantle the battery. The electrolyte contains sulfuric acid which can cause serious damage to eyes and skin. Should this occur, flush profusely with water and seek medical attention.
- Mixing batteries of different capacities, age and/or manufacture is not recommended. Please consult with an application engineer if it is unavoidably necessary.
- Battery life is dependent on its operating conditions. Please refer to the life curves published in this Applications Manual. These curves represent typical results under optimum operating conditions. Actual life will vary greatly due to variability of these conditions. To obtain optimum battery performance for standby service, EnerSys recommends that within five years of use, the NP batteries be replaced.
- Observe the external appearance of the battery. If, at any time, cracks, deformation or other damage is found on the battery case or cover, or if any leakage of the electrolyte is observed, immediately replace the battery.

Note: If a battery with any irregular appearance as stated above is used continuously, a decrease in capacity, leak age of electrolyte, short circuits and a potential for a smoke and/or fire incident may occur.

Glossary of Terms

Active Material	The active electro-chemical materials used in the manufacture of positive and negative electrodes.
Ambient Temperature	The average temperature seen by the battery.
Ambient Capacity	The capacity from the battery based on its state of charge, rate of discharge, and ambient temperature.
Battery	Two or more cells, series connected together. A single cell is some times referred to as a battery.
C-Rate	A current rate expressed in amperes or milliamperes, in direct relation to a battery's ampere hour rating. Ex: 6 Ah rating, 1C = 6 amps; 3C = 18 Amps; 0.05C = 300 milliamps.
CA	C Ampere; the C-rate of a battery measured in amperes.
Capacity Fade	Loss of capacity due to inadequate recharging.
Cell	The minimum unit of which a storage battery is composed. Note: The nominal voltage of a single lead acid cell is 2.0 volts.
Closed Circuit Voltage Test	A test method in which the battery is briefly discharged at a constant current while the voltage is measured.
Closed Voltage Test	A method of charging batteries by applying a fixed voltage and allowing the current to vary. Recommended for sealed lead acid batteries. (Also called constant potential charge).

Glossary of Terms (Continued)

Cutoff Voltage	The final voltage of a cell or battery at the end of charge or discharge.
Cycle	A single charge and discharge of a cell or battery.
Discharge Rate	Current taken from a cell or battery and expressed as a fraction of C (Ampere-hour rating of the cell or battery).
End-of-Charge Voltage	The voltage reached by the cell of battery at the end-of-charge, while the charger is still attached.
Electrolyte	Conducts ions in the cell. Lead acid batteries use a sulfuric acid solution.
Energy Density	Ratio of cell or battery energy to unit weight (pound or kilogram) or unit volume (cubic inch or cubic meter)
Gas Absorption	The ability of the negative plate to absorb oxygen gas generated within the battery; the greater this ability, the greater the charge current capability.
High-Rate Discharge	A very rapid discharge of the battery. Normally in multiples of C (Ampere-hour rating of the cell or battery).
Internal Impedance	The resistive value of the battery to an AC current, expressed in ohms. Normally measured at 1 khz at full charge.
Low Voltage Cutoff	A sensing device designed to end discharge at a predetermined voltage level.
Nominal Capacity	The nominal value of rated capacity. In sealed lead acid batteries, nominal capacity is usually measured at the 20 hour rate.
Nominal Voltage	The nominal value of rated voltage. In lead acid batteries, nominal voltage is 2 volts per cell.
Open Circuit Voltage	The measured voltage of the cell or battery without a load attached.
Overcharge	The continuous charging of a cell after it achieves 100% of capacity. Battery life is reduced by prolonged over charging.
Parallel Connection	Connection of a group of batteries by inter-connecting all terminals of the same polarity, thereby increasing the capacity of the battery group. (Note: Differing brands and/or capacities should not be connected together).
Primary Cell	A cell which can be discharged only once. Example: Manganese zinc and alkaline.
Rated Capacity	The capacity of the cell expressed in ampere hours. Commonly, a constant current for a designated number of hours to a specified depth of discharge at room temperature.
Resealable Safety Vent	The safety device built into the cell to allow the release of excess gases and prevent case rupture.
Secondary Battery	A battery which can be charged and discharged repeatedly. Example: Lead acid and nickel cadmium batteries.
Self Discharge	The loss of capacity of a battery while in stored or unused condition without external drain.
Separator	The materials which separate the electrodes. In a sealed lead acid battery, they are usually constructed of micro-porous glass fiber and additionally serve to retain the electrolyte.
Series Connection	Connection of a group of batteries by interconnecting all terminals of the opposite polarity, thereby increasing the voltage of the battery group. (Note: The same rule applies as with parallel connections).
Service Life	Expected life of a battery expressed in the number of total cycles or years of standby service to a designated remaining percentage of original capacity.
Shelf Life	The maximum period of time a battery can be stored under specific conditions, without supplementary charging.
Standby Service	A general term for an application in which the battery is maintained in a fully charged condition by trickle or float charging and always ready for use.
Trickle Charge	Continuous charging by means of a small current designed to compensate for self discharge in an unloaded battery.
Voltage Cutoff	A sensing device used to terminate a charge or discharge when the battery reaches a predetermined voltage level.

General Product Limited Warranty

EnerSys Delaware Inc. (“EnerSys”) warrants Genesis® NP, Genesis® NP-GEL and DataSafe™ NPX batteries against defective materials and workmanship for a period of one (1) full year from the date the battery was manufactured.

- A. If initial physical inspection identifies flaws in material or workmanship that would impair life of the battery, as defined by this warranty, or product performance, as defined by EnerSys’ electrical and physical specification as published at the time of shipment and these flaws are not due to transportation damage or installation abuse;

OR

- B. If on initial “Acceptance Test”, as defined in IEEE Std. 1188, “IEEE Recommended Practice for Maintenance, Testing, and Replacement of Valve Regulated Lead Acid (VRLA) Batteries for Stationary Applications”, the properly installed battery and/or string fails to meet the published performance ratings* per EnerSys’ latest published catalog data at the time of shipment;

In the event of either A or B above, then contact your nearest EnerSys sales representative to request instructions. You will be instructed either a) to return the equipment to an EnerSys factory or service center location, FOB Destination-Freight Prepaid, for examination, or b) to wait until an EnerSys representative arrives at the site to inspect the equipment.

If EnerSys determines the battery is physically or electrically unsound due to defective materials or workmanship on the part of EnerSys, the defective battery(s) will be repaired or replaced at the option of EnerSys without charge to the purchaser (user) for replacement materials. However, costs of replacement installation including but not limited to equipment, travel expenses of EnerSys representatives(s), and costs of material transportation expenses shall be borne by the purchaser (user).

* Published performance ratings. Initial capacity shall be a minimum of 90 percent of the rated string capacity upon shipment per IEEE-1188.



NON-SPILLABLE



When ordering new batteries, also remember the need to properly dispose (recycle) your old lead-acid batteries.

Most federal and state regulations require lead-acid batteries be recycled. EnerSys’ nationwide service organization can arrange pickup, transportation, and recycling to any one of our company affiliated smelters. Call 1-800-972-7372 for more information.



www.enersys.com

EnerSys
P.O. Box 14145
Reading, PA 19612-4145
USA
Tel: +1-610-208-1991
+1-800-538-3627

EnerSys EMEA
Brussels, Belgium
Tel: +32 (0)2 247 94 47
EnerSys Asia
Guangdong, China
Tel: +86 755 2689 3639

Represented by:

Printed in U.S.A.
© 2006 EnerSys. All rights reserved.
Trademarks and logos are the property of EnerSys and its affiliates unless otherwise noted.