

GHz-band, high-accuracy SAW resonators and SAW oscillators

The evolution of wireless communications and semiconductor technologies is spurring the development and commercialization of a variety of applications that use gigahertz-range frequencies.

These new applications increasingly require highly accurate and stable gigahertz-range crystal timing devices that employ a resonator's fundamental oscillation mode, without the need for a phase locked loop (PLL) referenced to high harmonic oscillations or low frequency oscillations.

Epson Toyocom responded by developing the NS-34R resonator and a pair of low-noise oscillators that employ the NS-34R, the EG-9000GC and EV-9000GB. The NS-34R is based on an original Epson Toyocom ST-cut crystal surface acoustic wave (SAW) resonator that was already proven in volume production for resonant frequencies up to 800 MHz. Epson Toyocom used its manufacturing technology to further scale down and increase the stability of IDTs (comb-shaped electrodes disposed in a regular pattern on a quartz substrate) to enable the NS-34R to support resonant frequencies as high as 2.5 GHz.

1. SAW Resonator: The NS-34R



Photo 1. NS-34R

Background: STWs (surface transverse waves), which propagate fast even for SAWs, were conventionally used to achieve GHz-range resonance at the fundamental mode. However, high-accuracy STW devices are difficult to achieve because their frequency is highly sensitive to electrode linewidth and film thickness, which makes them susceptible to the effects of variation in manufacturing processes.

Conversely, the frequency of crystal SAW resonators that use Epson Toyocom's original ST-cut substrates and that the company has mass produced at resonant frequencies up to 800 MHz is far less sensitive to electrode linewidth and film thickness than STW resonators. Moreover, these crystal SAW resonators boast a frequency-temperature coefficient that is approximately three times better than that of an STW resonator.

Given the advantages, Epson Toyocom set about applying its microfabrication and stabilization technologies in an effort to scale down the geometries of the comb-shaped electrodes and succeeded in developing the highly accurate NS-34R SAW resonator, which supports resonant frequencies up to 2.5 GHz.

Table 1. NS-34R Main Specifications

Item	Specifications
Nominal frequency range	800 MHz - 2500 MHz
Frequency stability	$\pm 200 \times 10^{-6}$
Turnover temperature	$+37.5 \text{ }^\circ\text{C} \pm 20 \text{ }^\circ\text{C}$
Parabolic coefficient	$(-0.016 \pm 0.004) \times 10^{-6} / \text{ }^\circ\text{C}^2$
Operating temperature range	0 °C to 75 °C (Products with wider temperature range under development)
External dimensions (mm)	3.8 x 3.8 x 0.98t mm

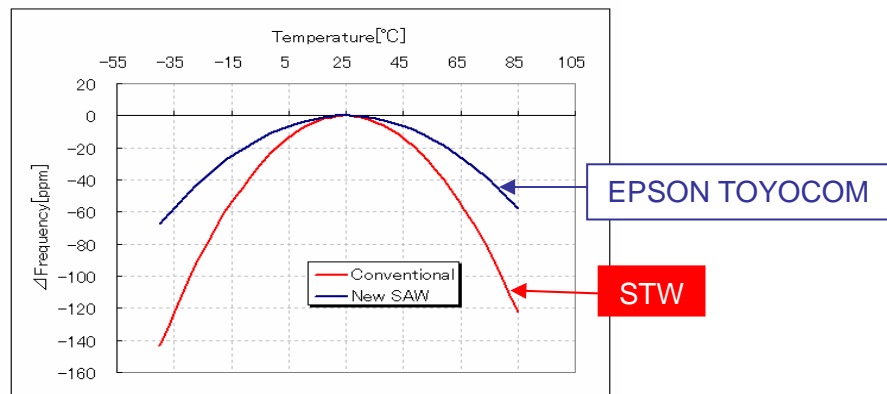

Figure 1. NS-34R temperature-frequency characteristic

Features: The NS-34R has a frequency stability of $\pm 200 \times 10^{-6}$, including initial frequency tolerance, frequency-temperature coefficient and aging. It also has a good frequency-temperature characteristic.

A resonator that uses a 2-port structure, the NS-34R's electrical characteristics include a Q value of 1000 and insertion loss of 6 dB. Furthermore, the power durability of the NS-34R is such that it can withstand the application of power in excess of +10 dBm. The use of an NS-34R makes it possible to achieve a low phase noise oscillator by propagating high-power signals within the oscillation loop while taking advantage of the NS-34R's high Q value. In addition, since the NS-34R has a VSWR of 1.5 or less at the center frequency, a matching circuit is not needed when the resonator is built into an oscillation circuit, so the NS-34R also contributes to oscillator miniaturization.

The package dimensions are 3.8 x 3.8 x 0.98t mm.

2. GHz-Band Direct-Drive SAW Oscillators: EG-9000GC & EV-9000GB

Background: Epson Toyocom used the NS-34R to develop the EG-9000GC SAW oscillator and the EV-9000GB voltage-controlled SAW Oscillator (VCSO), both of which directly excite oscillation in the GHz band.

Two common types of oscillation circuits use a SAW resonator: a Colpitts type or other negative resistance oscillation circuit and a feedback type oscillation circuit. Both the EG-9000GC and the EV-9000GB use the feedback type. The feedback type has a high part count, but since it uses a 2-port SAW resonator, it can provide a high degree of amplification even in the GHz range.



Photo 2. EV-9000GB

Photo 3. EG-9000GC

Table 2. EV-9000GB and EG-9000GC Main Specifications

	EG-9000GC	EV-9000GB (voltage-controlled model)
Frequency tolerance	$\pm 150 \times 10^{-6}$ Max.	
Frequency control range	-	TBD
Operating temperature range	-20 °C to +60 °C	
Output frequency range	800 MHz to 2.5 GHz	
Power supply voltage	3.0 V	
Current consumption	38 mA Max.	
Output waveform	sine wave	
External dimensions	10.0 x 10.0 x 2.8t mm	14.0 x 9.0 x 2.8t mm

GHz-band, high-accuracy SAW resonators and SAW oscillators

Features: Figure 2 shows an oscillation block diagram. The basic circuit configuration of the EG-9000GC consists of a SAW resonator, high-frequency amplifier, power divider, and frequency tuning circuit. In the configuration used for the EV-9000GB, a voltage controlled phase shifter, was added between the power divider and frequency tuning circuit. The blocks are 50-Ohm matched. Circuit block details are provided below.

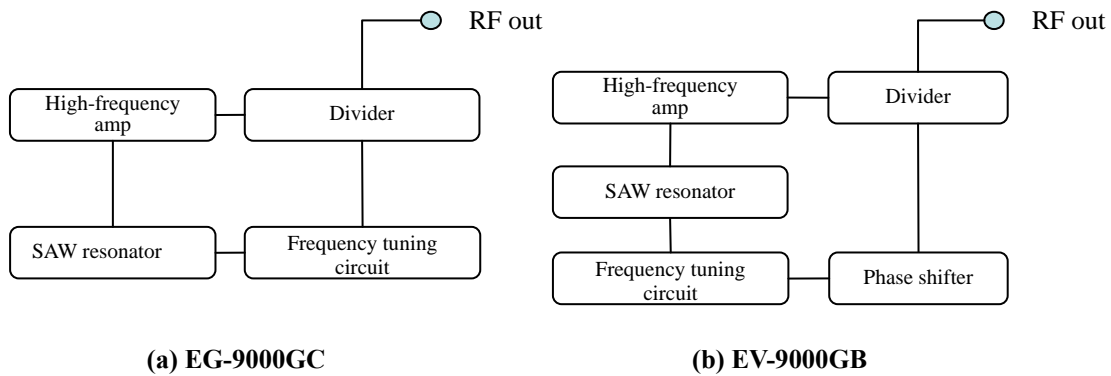

Figure 2. Oscillation circuit configuration

First, the resonator is an NS-34R, which offers a high Q, low insertion loss, high power durability and good temperature-frequency coefficient. The NS-34R's low VSWR and high power durability contribute to miniaturization of the oscillators because they do not need an external attenuator or matching circuit. Achieving low phase noise requires a high-frequency amplifier with a low NF and high saturated output power. Accordingly, a medium-output MMIC that does not need an input-output matching circuit and that provides approximately 10 dBm of saturated output power, yet possesses a low NF, was used as the high-frequency amplifier.

Next, a power divider was needed that could be connected without disrupting the matched condition on the other circuit blocks and that had good isolation against load fluctuations. A Wilkinson power divider, a type of power divider that provides a high degree of isolation, was thus selected. The power divider can be placed immediately after the amplifier to obtain high output power without an output buffer and also to contribute to miniaturization.

Finally, the phase shifter has to maintain constant input/output impedance even when control voltage is changed, so a reflective phase shifter that uses a variable capacitance diode and includes a 3 dB hybrid branch line coupler was selected.

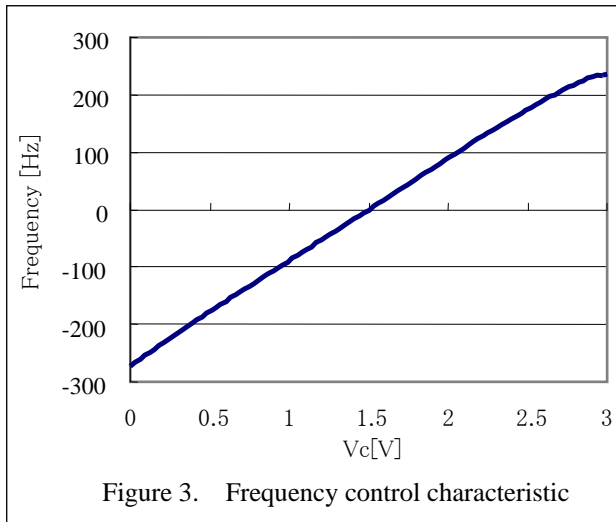

Figure 3 shows the voltage control characteristic of the EV-9000GB (oscillation frequency: 2.40 GHz). The frequency control range is about 500 ppm at a control voltage of from 0 to 3 V. Output power is approximately 6 dBm. Power fluctuations triggered by control voltage is 0.5 dBm.

Figure 4 shows the broadband spectrum characteristics of the EV-9000GB (oscillation frequency: 2.40 GHz). Because the spurious is -35 dBc or higher, the output waveform closely approximates a sine wave, and because the oscillation frequency is directly excited, the spectrum includes only high harmonics of an integral multiple of the reference wave.

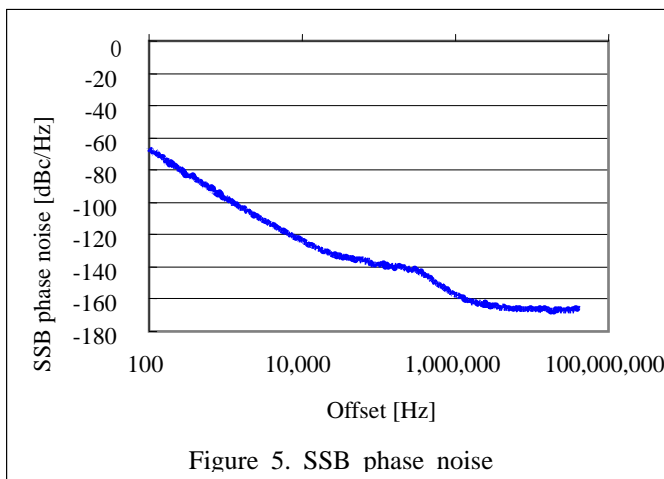
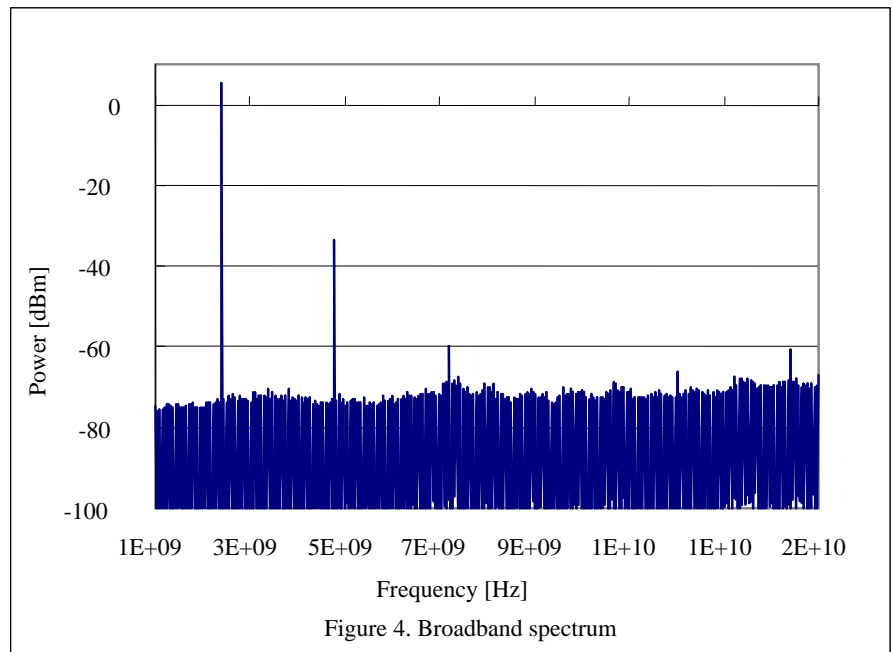

Figure 5 shows the phase noise characteristic of the EV-9000GB (oscillation frequency: 2.40 GHz). Phase noise at an offset frequency of 1 kHz is -95 dBc or less, and the noise floor is -165 dBc or less. Phase jitter at offset frequencies ranging from 12 kHz up to 20 MHz are 0.5 ps or less.

3. Fields of Application

In recent years, the communications market has been moving toward higher frequency carriers and broader modulation bandwidths to enable large volumes of data to be transferred faster and more accurately. Exemplifying this trend is research into millimeter-wave wireless personal area networks (WPAN) that use a 60-GHz band carrier and are capable of transfer speeds of 1 Gbps and beyond. Gigahertz range applications are also burgeoning in other markets. Rapid strides are being made in markets that apply 2.45-GHz microwaves to synthesize or decompose materials, as well as in automotive markets, where applications include 76-GHz millimeter-wave radar. Uses for high frequencies are expected to multiply in these and other markets going forward. (See Figure 6.)

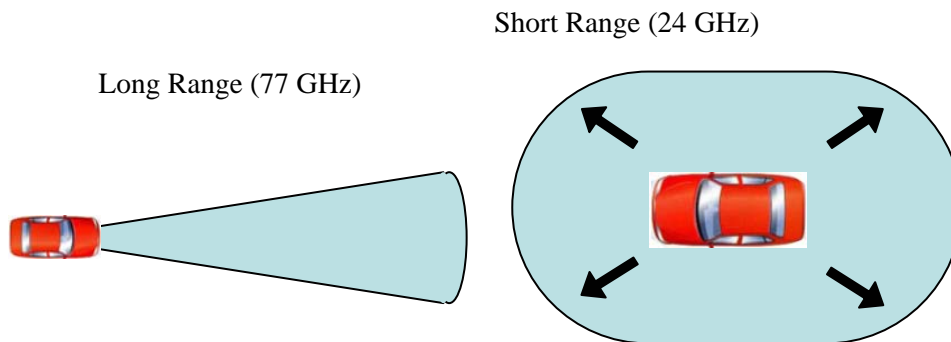
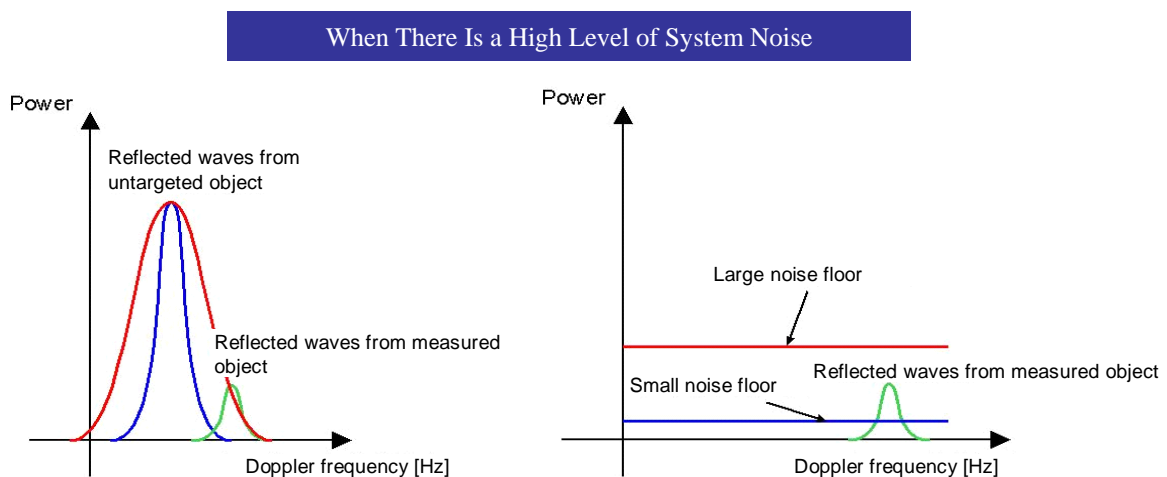

Figure 6. Sample millimeter wave radar applications

Using a reference oscillation source that is of the highest possible frequency in these applications enables low phase noise, low jitter, excellent high-speed oscillation signal startup and low power consumption. For example, in the case of millimeter-wave radar, if there is a high level of noise produced by reflected waves from untargeted objects, the waves reflected by the measured object become buried by system noise, making it difficult to receive the reflected waves from the measured object. This is why a system configuration that minimizes noise produced by reflected waves from untargeted objects is ideal (Figure 7).



Reflected waves from measured objects, shown in green, are buried below the noise floor of the system.

Figure 7. The important feature in millimeter-wave radar

Figure 8 shows the simulated result of phase noise when the system reference signal is multiplied up to 79 GHz using oscillating frequencies of 150 MHz, 300 MHz, 600 MHz and 2.5 GHz for the system's reference signal source.

This result shows that using a high frequency for the system's reference signal source can mitigate system noise and create an environment in which a measured object's reflected waves are easily received. The NS-34R crystal SAW resonator and the EG-9000GC/EV-9000GB oscillators that apply the NS-34R can help improve the performance of a variety of applications.

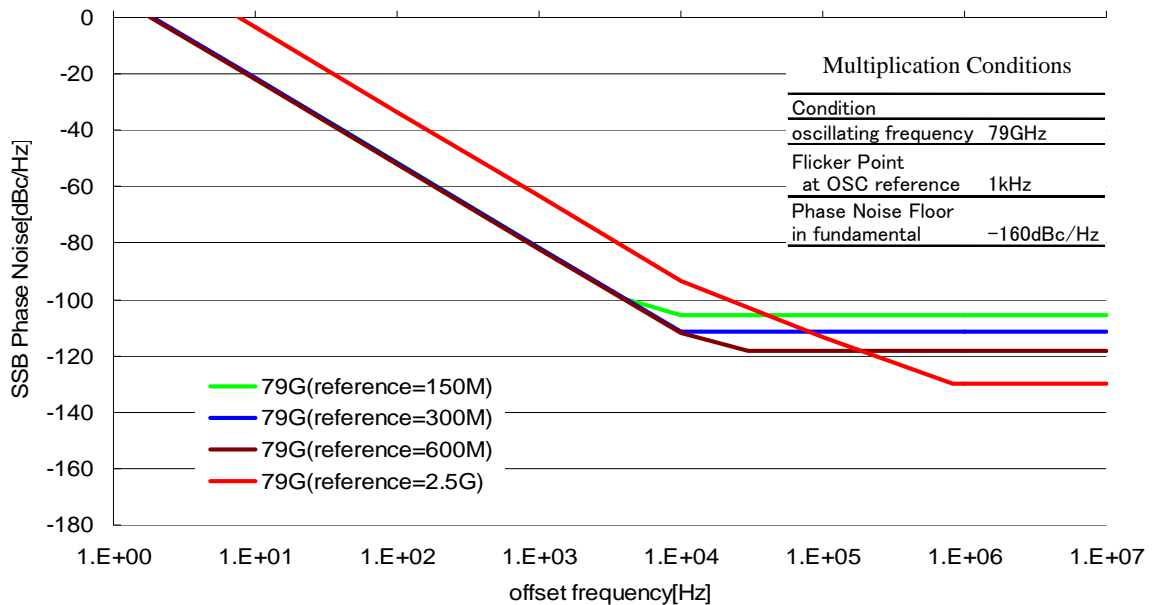

Figure 8. Phase noise at 79 GHz (simulated result)

Note: When the system's reference signal is multiplied on a PLL oscillator, the phase noise characteristics of the VCO appear at the offset frequency after the cut-off frequency of the LPF.

About Epson Toyocom

Epson Toyocom Corporation was formed through the integration of the quartz business of Seiko Epson Corporation and Toyo Communication Equipment Co., Ltd. in October 2005. Epson Toyocom follows a "3D strategy" designed to drive both horizontal growth through expansion in three device categories—timing devices, sensing devices and optical devices—and vertical growth through combinations of products in these categories. With this strategy, Epson Toyocom aims to be the leading company in the quartz device industry, selling a wide range of products to customers worldwide, from cellular phones for consumer fields, to industrial fields such as core network systems and automotive systems.

The company's timing devices are extremely accurate, stable crystal products that serve as reference signal sources in all manner of devices. The lineup currently includes products in frequencies ranging from the kilohertz band up to 2.5 GHz range. In the kilohertz range, Epson Toyocom offers tuning forks. At frequencies up to about 100 MHz, Epson Toyocom offers AT-crystal products that use thickness-shear vibration. In the hundreds of megahertz range, the company applies its AT vibration technology to provide crystal products that use an HFF (high-frequency fundamental) or SAW (surface acoustic wave).

Epson Toyocom website: <http://www.epsontoyocom.co.jp/english>

- The material is subject to change without notice.
- The information, applied circuit, program, usage etc., written in this material is just for reference. Epson Toyocom does not assume any liability for the occurrence of infringing any patent or copyright of a third party. This material does not authorize the licensing for any patent or intellectual copyrights.