

晶振

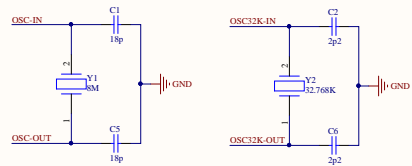

复位电路

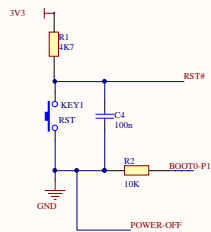

MCU 电源

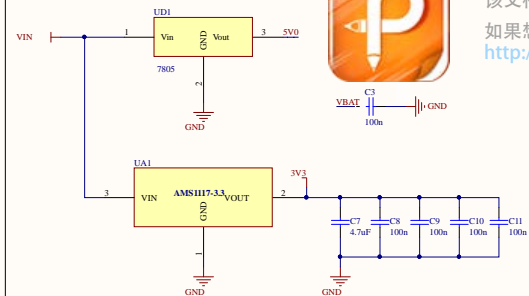

ST Link 下载接口
 该文档是极速PDF编辑器生成，
 如果想去掉提示，请访问并下载：
<http://www.jisupdfeditor.com/>

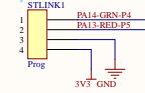

GPIO接口

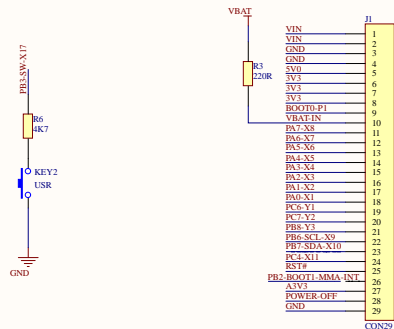

Micro USB 接口

Micro USB 接口

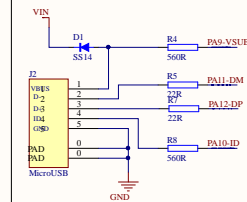

MCU

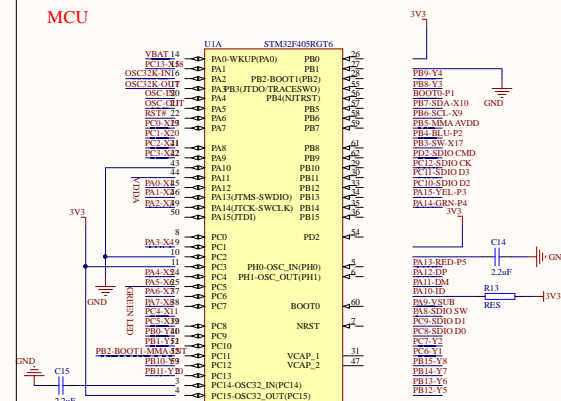

指示灯

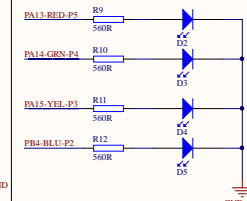

LED GREEN

