

# TFT

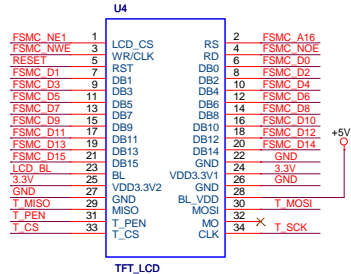

TFT\_LCD

FTFLCD-34

# JTAG/SWO

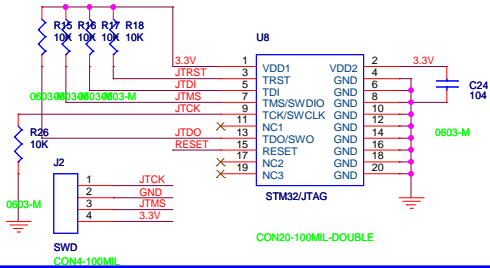

STM32JTAG

CON20-100MIL-DOUBLE

# I/O

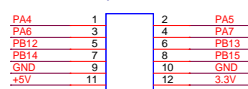

SPH1/2

CON6X2-100MIL

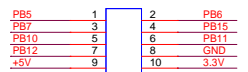

I2C1/2

CON5X2-100MIL

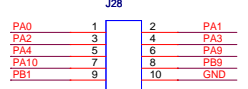

USART1/2

CON5X2-100MIL

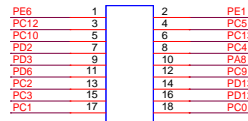

GPIO

CON9X2-100MIL

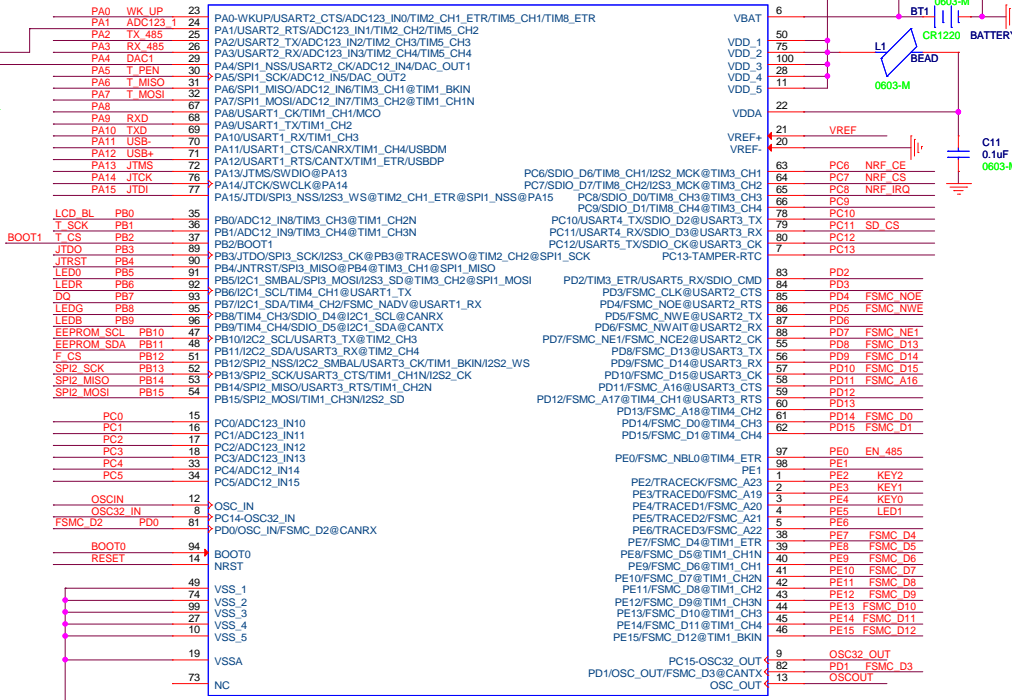
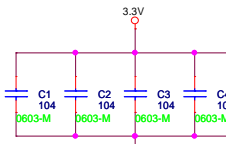

# STM32F103VC

STM32F103\_LQFP\_100P

STM32\_TQFP100

# BOOT

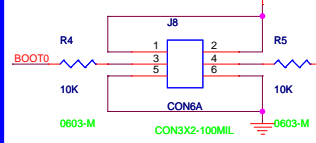

# LED

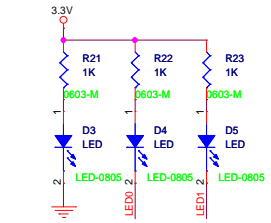

# KEY

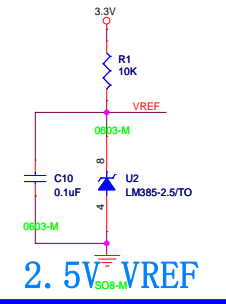
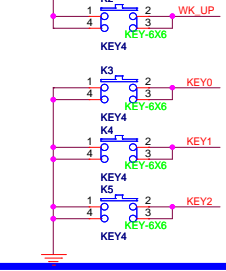

# 2.5V VREF

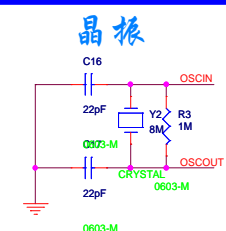
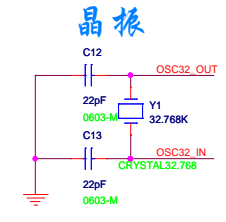

# RESET

- LEDR >>> LEDR
- LEDB >>> LEDB
- EEPROM\_SDA >>> EEPROM\_SDA
- EEPROM\_SCL >>> EEPROM\_SCL
- RX\_485 >>> RX\_485
- TX\_485 >>> TX\_485
- EN\_485 >>> EN\_485
- USB+ >>> USB+
- USB- >>> USB-
- F\_CS >>> F\_CS
- BOOT0 >>> BOOT0
- RESET >>> RESET
- TXD >>> TXD
- RXD >>> RXD
- SD\_CS >>> SD\_CS
- SPH2\_MOSI >>> SPH2\_MOSI
- SPH2\_SCK >>> SPH2\_SCK
- SPH2\_MISO >>> SPH2\_MISO
- NRF\_CE >>> NRF\_CE
- NRF\_CS >>> NRF\_CS
- NRF\_IRQ >>> NRF\_IRQ
- DQ >>> DQ

# 电子科技潮流

Model Name DZKJ	Customer Part Number <NUMBER>
Size XL Part Number Custom<Number>	Drawing Number <Doc>
Approval <Approval>	Check <Check>
Design <Design>	Rev <RevCode>
Date: Friday, February 28, 2014	Sheet 1 of 1

- EEPROM\_SDA >> EEPROM\_SDA
- EEPROM\_SCL >> EEPROM\_SCL
- RX\_485 >> RX\_485
- TX\_485 >> TX\_485
- EN\_485 >> EN\_485
- USB+ >> USB+
- USB- >> USB-
- F\_CS >> F\_CS
- BOOT0 >> BOOT0
- RESET >> RESET
- TXD >> TXD
- RXD >> RXD
- SD\_CS >> SD\_CS
- SPI2\_MOSI >> SPI2\_MOSI
- SPI2\_SCK >> SPI2\_SCK
- SPI2\_MISO >> SPI2\_MISO
- NRF\_CE >> NRF\_CE
- NRF\_CS >> NRF\_CS
- NRF\_IRQ >> NRF\_IRQ
- DQ >> DQ
- LEDR >> LEDR
- LEDG >> LEDG
- LEDB >> LEDB

### EEPROM

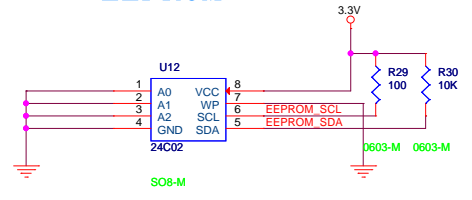

### SD\_CARD

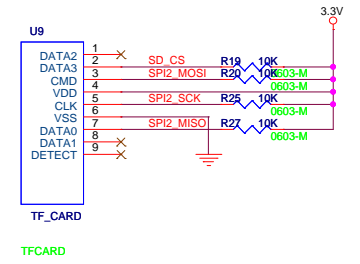

### 485

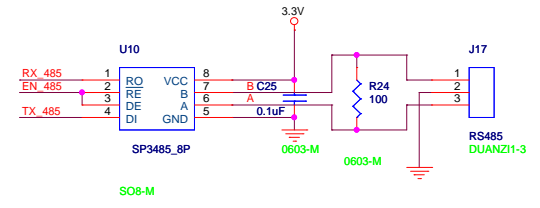

### 电源

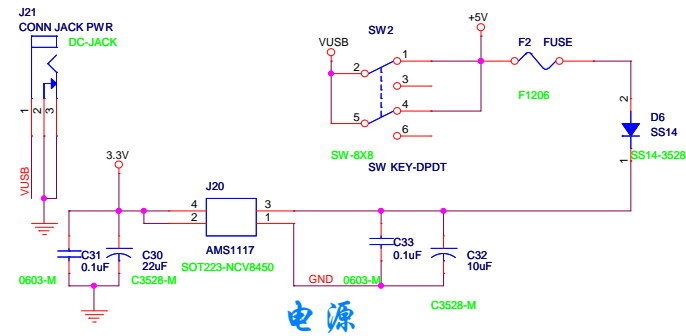

### DS18B20&DHT11

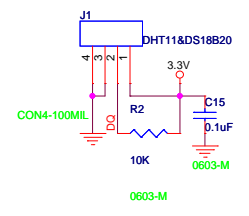

### CAN&USB

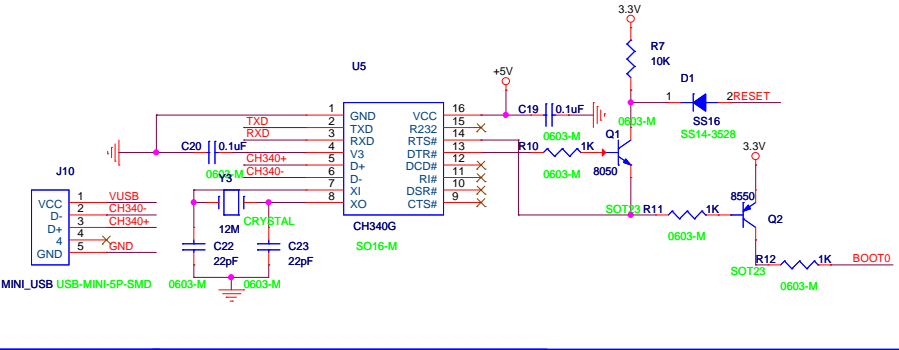
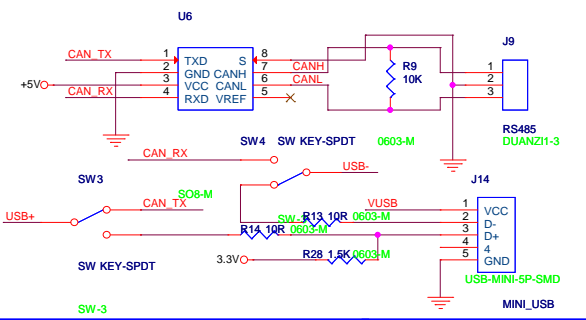

- kong1
- kong2
- 0603-M
- kong3
- kong4
- 0603-M
- KONG

### 无线

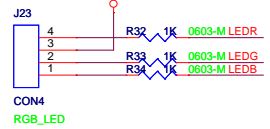
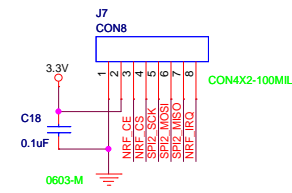

### Flash

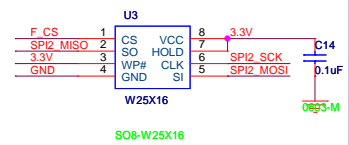

### 电子科技潮流

Model Name DZKJ		Customer Part Number <NUMBER>	
Size XL Part Number Custom<Number1>	Drawing Number <Doc>		Rev <RevCode>
Approval <Approval>	Check <Check>	Design <Design>	
Date: Monday, February 17, 2014		Sheet 1 of 1	