

系统供电稳压

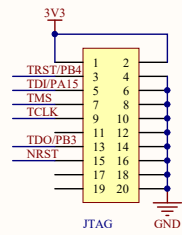

调试JTAG、SWD接口

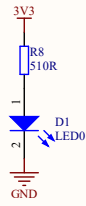
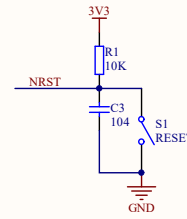

系统复位

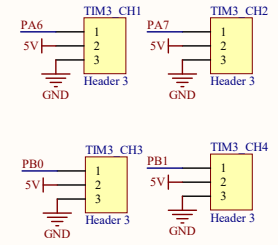

舵机接口

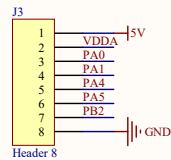
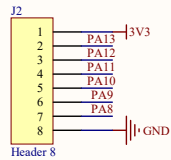
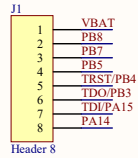

通用I/O接口

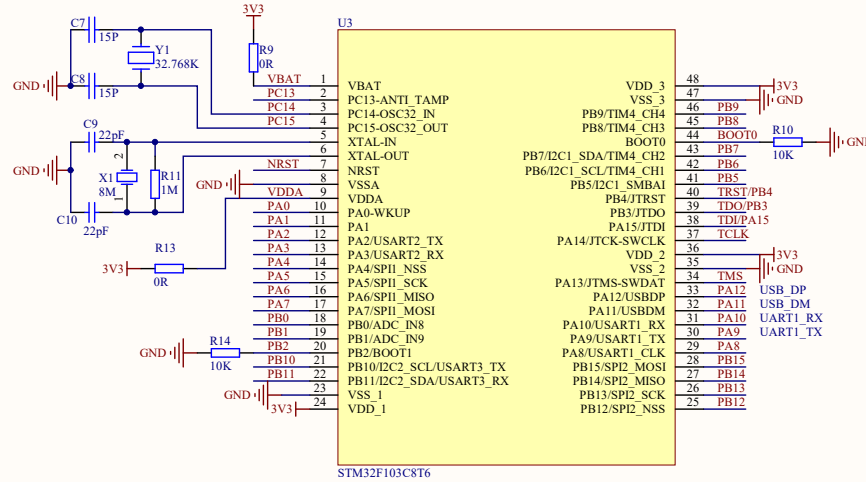

滤波

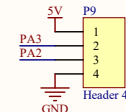

陀螺仪

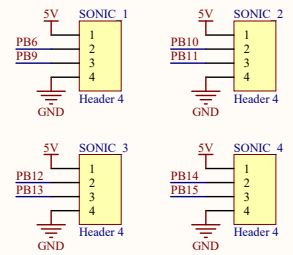

超声波接口

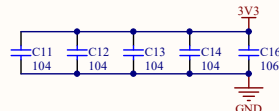

滤波

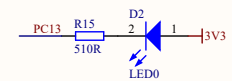

LED灯

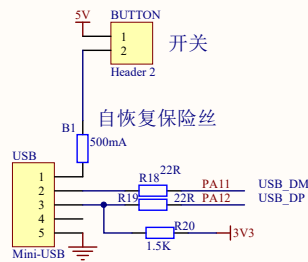

供电、开关及usb-hid



电池供电接口

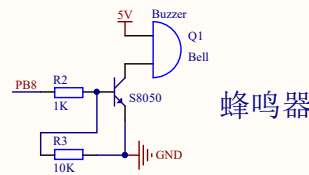

蜂鸣器

Title		
Size A3	Number	Revision
Date: 04.03.2017	Sheet of	
File: C:\Users\...\STM32F103C8T6.SchDoc	Drawn By:	