

电机

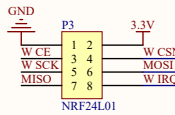

无线接收

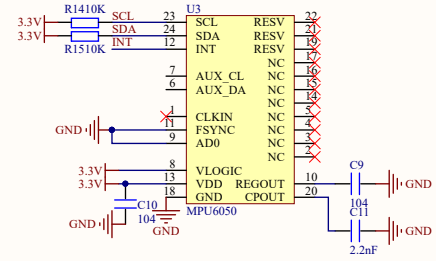

陀螺仪MPU6050

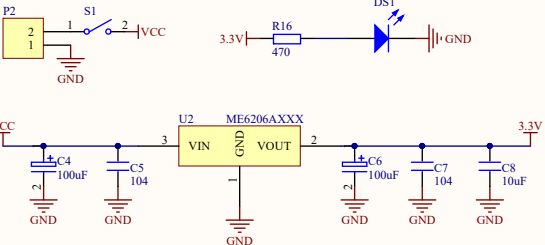

电源稳压模块

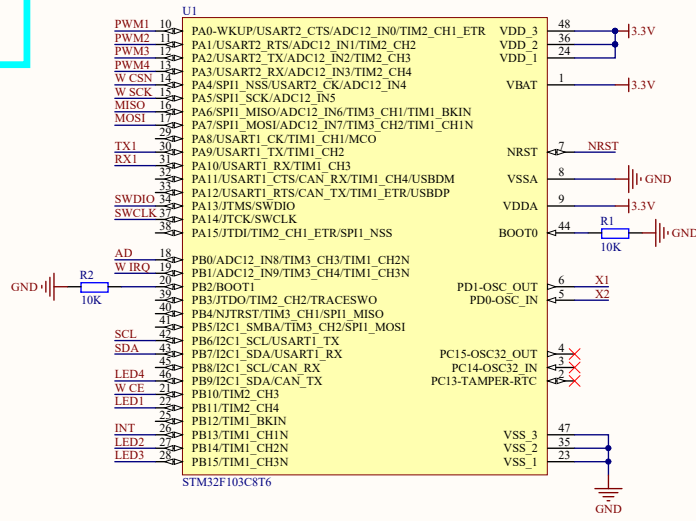

STM32F103C8T6

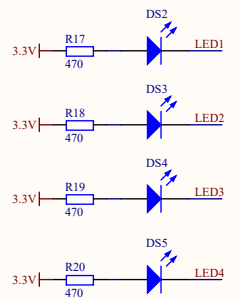

四轴指示灯

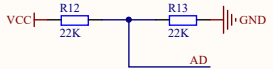

晶振

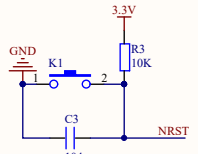
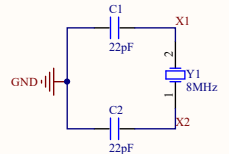

复位电路

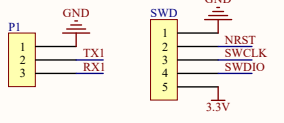

程序下载电路

Title		
Size	Number	Revision
A3		
Date:	2016/6/11	Sheet of
File:	F:\PCB制图\M32_SchDoc	Drawn By:

