

## Throttle Position Sensor in Hall Effect Technology Hollow and D-Shaft Versions

**DESIGN SUPPORT TOOLS**
[click logo to get started](#)
**3D**  
Models  
Available

**FEATURES**

- Accurate linearity down to:  $\pm 0.5\%$
- Easy mounting principle
- Non contacting technology: Hall effect
- Model dedicated to all applications in harsh environments
- Spring loaded types available
- Material categorization: for definitions of compliance please see [www.vishay.com/doc?99912](http://www.vishay.com/doc?99912)

**RoHS**  
COMPLIANT

| QUICK REFERENCE DATA |                                     |
|----------------------|-------------------------------------|
| Sensor type          | ROTATIONAL, single turn hall effect |
| Output type          | Wires                               |
| Market appliance     | Industrial                          |
| Dimensions           | 47 mm x 22 mm                       |

| ELECTRICAL SPECIFICATIONS           |  |  |
|-------------------------------------|--|--|
| PARAMETER                           | STANDARD   | SPECIAL  |
| Electrical angle                    | 90°, 120°, 180°, 270°, 360°  | Any other angle upon request                       |
| Linearity                           | $\pm 1\%$  | $\pm 0.5\%$  |
| Supply voltage                      | 5 V <sub>DC</sub> $\pm 10\%$   | Other upon request                                 |
| Supply current                      | 10 mA typical / 16 mA max.   | 16 mA for PWM output                               |
| Output signal                       | Analog ratiometric 10 % to 90 % of V <sub>supply</sub> or PWM 1 kHz, 10 % to 90 % duty cycle | Other upon request                                 |
| Over voltage protection             |  | +20 V <sub>DC</sub>                                |
| Reverse voltage protection          |  | -10 V <sub>DC</sub>                                |
| Load resistance recommended         |  | Min. 1 k $\Omega$ for analog output and PWM output |
| Hysteresis static (D-shaft version) |  | < 0.3°   |

| MECHANICAL SPECIFICATIONS |  |
|---------------------------|--|
| PARAMETER                 |  |
| Mechanical travel         | 360° continuous, stops upon request: 124° $\pm 3^\circ$        |
| Bearing type              | Sleeve bearing   |
| Standard                  | IP 50; other on request  |
| Weight                    | 19 g $\pm 2$ g hollow shaft model/22 g $\pm 2$ g D-shaft model |

| ORDERING INFORMATION/DESCRIPTION |   |                |                  |             |                 |               |   |                  |             |
|----------------------------------|---|----------------|------------------|-------------|-----------------|---------------|---|------------------|-------------|
| 981HE                            | 0   | A              | 1                | W           | A               | 1F16          | XXXX  | BO 10            | e1          |
| MODEL                            | FEATURES                                    | LINEARITY      | ELECTRICAL ANGLE | OUTPUT TYPE | OUTPUT SIGNAL   | SHAFT TYPE    | SPECIAL REQUEST                                   | PACKAGING        | LEAD FINISH |
| 0:                               | continuous rotation                         | A: $\pm 1\%$   | 1: 90°           | W: wires    | A: analog CW    | 1: 6.35 mm    |   | Box of 10 pieces |             |
| 1:                               | mechanical stops                            | B: $\pm 0.5\%$ | 2: 180°          | Z: custom   | B: analog CCW   | 9: special    |   |                  |             |
| 2:                               | spring return CW                            |                | 3: 270°          |             | C: PWM CW       | P: plain      |   |                  |             |
| 3:                               | spring return CCW                           |                | 4: 360°          |             | D: PWM CCW      | F: flatted    |   |                  |             |
|                                  |   |                | 5: 120°          |             | Z: other output | S: slotted    |   |                  |             |
|                                  | For 1, 2, 3: max. electrical angle is: 120° |                | 9: other angles  |             |                 | Z: other type |   |                  |             |
|                                  |   |                |                  |             |                 |               | Shaft length from mounting face (standard: 16 mm) |                  |             |
|                                  |   |                |                  |             |                 |               | 8H00 hollow shaft                                 |                  |             |
|                                  |   |                |                  |             |                 |               | 8H01 hollow D-shaft                               |                  |             |

| SAP PART NUMBERING GUIDELINES |                     |           |                  |             |               |            |                 |
|-------------------------------|---------------------|-----------|------------------|-------------|---------------|------------|-----------------|
| 981HE                         | 1                   | B         | 9                | Z           | C             | 8H01       | XXXX            |
| MODEL                         | MECHANICAL FEATURES | LINEARITY | ELECTRICAL ANGLE | OUTPUT TYPE | OUTPUT SIGNAL | SHAFT TYPE | SPECIAL REQUEST |
|                               |                     |           |                  |             |               |            |                 |



**V<sub>OUT</sub> ANALOG**

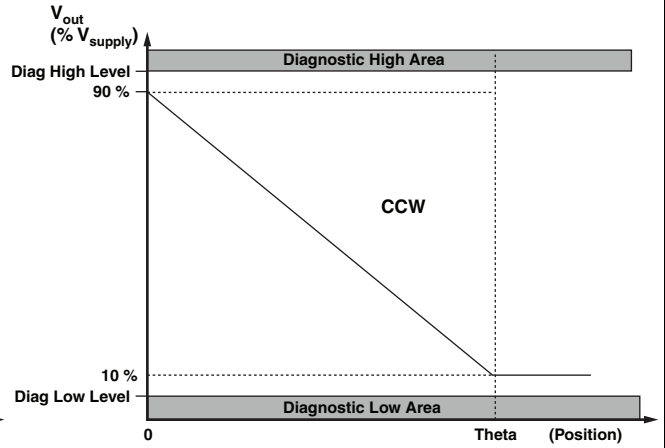
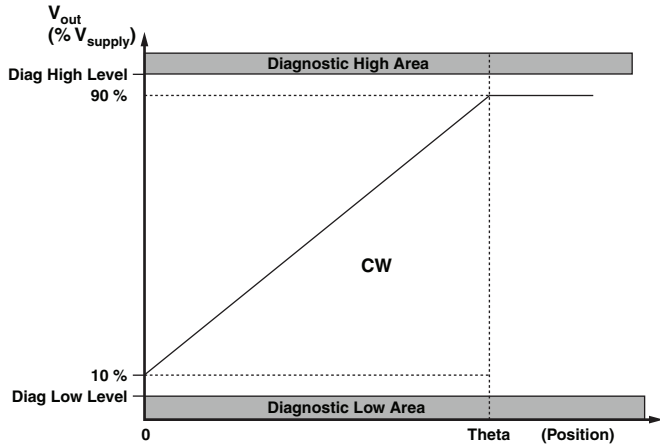

**V<sub>OUT</sub> PWM**



| DIAGNOSTIC MODES                          |                                   |                                     |  |
|---|-----------------------------------|-------------------------------------|--|
| FAILURE                                   | $V_{out}$ ANALOG<br>$R_{pull-up}$ | $V_{out}$ ANALOG<br>$R_{pull-down}$ | $V_{out}$ PWM<br>$R_{pull-up} = 1\text{ k}\Omega$<br>$V_{pull-up} = V_{supply} = 5\text{ V}$ |
| 1: Broken GND                             | Diagnostic high area              | Diagnostic low area                 | $> 97\% V_{supply}$<br>without modulation  |
| 2: Broken $V_{out}$                       | Diagnostic high area              | Diagnostic low area                 | $> 97\% V_{supply}$<br>without modulation  |
| 3: Broken $V_{supply}$                    | Diagnostic high area              | Diagnostic low area                 | $> 97\% V_{supply}$<br>without modulation  |
| Over voltage $V_{supply} > 7\text{ V}$    | Diagnostic high area              | Diagnostic low area                 | $> 97\% V_{supply}$<br>without modulation  |
| Under voltage $V_{supply} < 2.7\text{ V}$ | Diagnostic high area              | Diagnostic low area                 | $> 97\% V_{supply}$<br>without modulation  |

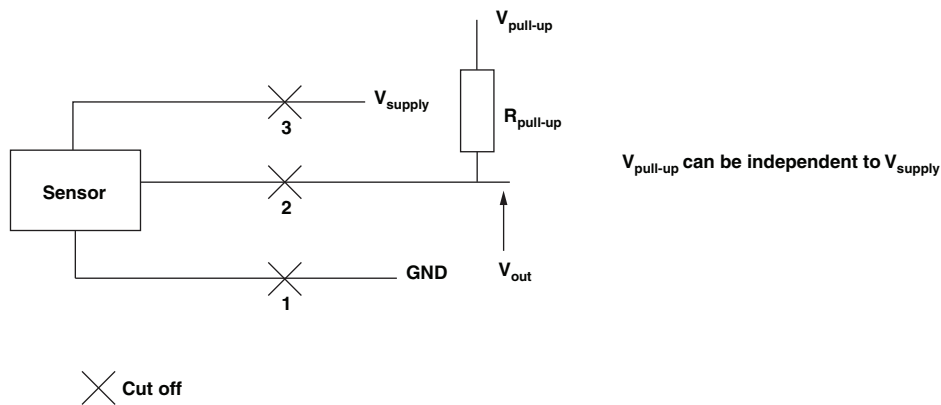

| ENVIRONMENTAL SPECIFICATIONS                      |  |
|---|--|
| Vibrations  | 20 g from 10 Hz to 2000 Hz, EN 60068-2-6   |
| Shocks  | 3 shocks/axis; 50 g half a sine 11 ms, EN 60068-2-7  |
| Operating temperature range                       | -45 °C to +125 °C  |
| Life (in cycles)                                  | $> 5\text{ M}$ for hollow shaft model / $> 10\text{ M}$ for D-shaft model                  |
| Rotational speed (max.)                           | 120 rpm  |
| Immunity to radiated electromagnetic disturbances | 200 V/m 150 kHz/1 GHz, IEC 62132-2 part 2 (level A)  |
| Immunity to power frequency magnetic field        | 200 A/m 50 Hz / 60 Hz, EN 61000-4-8 (level A)  |
| Radiated electromagnetic emissions                | 30 MHz / 1 GHz $< 30\text{ dB}\mu\text{V/m}$ , EN 61000-6-4 (level A)                      |
| Electrostatic discharges                          | Contact discharges: $\pm 8\text{ kV}$<br>Air discharges: $\pm 15\text{ kV}$ , EN 61000-4-2 |
| MATERIALS   |  |
| Housing   | Thermoplastic housing  |
| Shaft   | Stainless steel  |
| Output  | 3 lead wires   |

**Note**

- Nothing stated herein shall be construed as a guarantee of quality or durability



**DIMENSIONS** in millimeters

**VARIOUS POSSIBLE TYPES OF MODEL 981 HE  
IN D-SHAFT VERSION**

① 981 HE D-Shaft  
Spring return CCW  
Shaft:  $\varnothing$  6.35 flatted length 16 mm FMF  
Model: 981HE-3-x-x-W-x-1F16

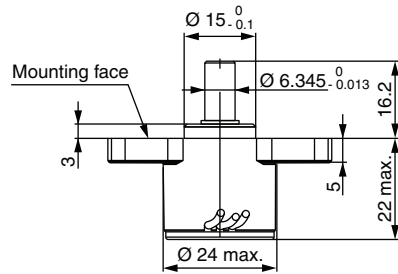
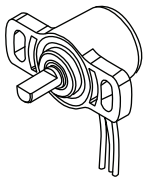

② 981 HE D-Shaft  
Spring return CW  
Shaft:  $\varnothing$  6.35 flatted 16 mm FMF  
Model: 981HE-2-x-x-W-x-1F16

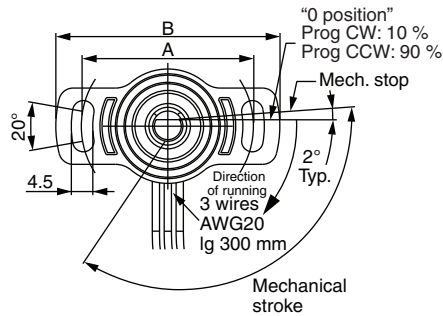
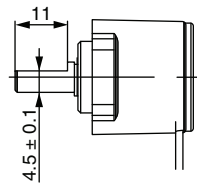
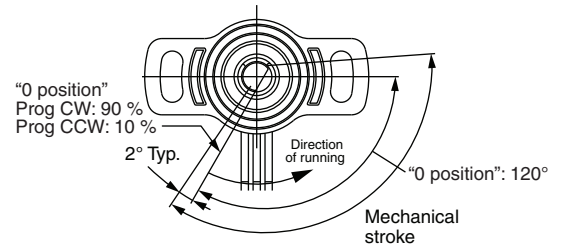

③ 981 HE D-Shaft  
Continuous rotation  
Shaft:  $\varnothing$  6.35 flatted 16 mm FMF  
Model: 981HE-0-x-x-W-x-1F16

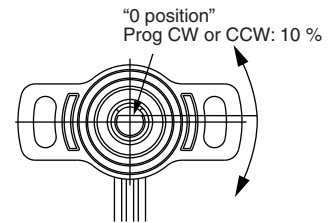

| Dimension | Standard | Option | Wires                        |
|-----------|----------|--------|------------------------------|
| A         | 36       | 38     | Yellow GND (-)<br>Red Signal |
| B         | 47       | 48     | Green V <sub>CC</sub> (+)    |



### DIMENSIONS in millimeters

#### VARIOUS POSSIBLE TYPES OF MODEL 981 HE IN HOLLOW SHAFT VERSION

④ 981 HE Hollow shaft  
Spring return CCW  
Shaft:  $\varnothing 8$   
Model: 981HE-3-x-x-W-x-8H00

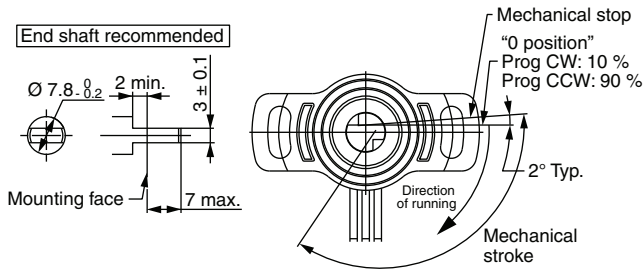

⑥ 981 HE Hollow D-Shaft  
Continuous rotation  
Shaft:  $\varnothing 8$   
Model: 981HE-0-x-x-W-x-8H01

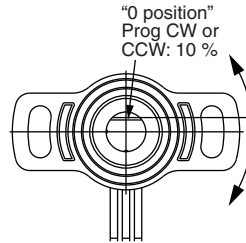

⑦ 981 HE Hollow D-Shaft  
CW  
Shaft:  $\varnothing 8$   
Model: 981HE-1-x-x-W-x-8H01

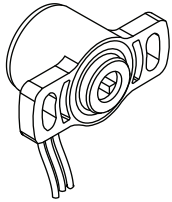
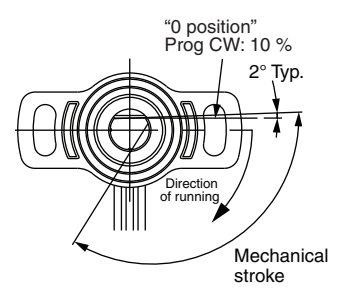

⑤ 981 HE Hollow shaft  
Spring return CW  
Shaft:  $\varnothing 8$   
Model: 981HE-2-x-x-W-x-8H00

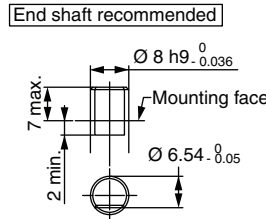
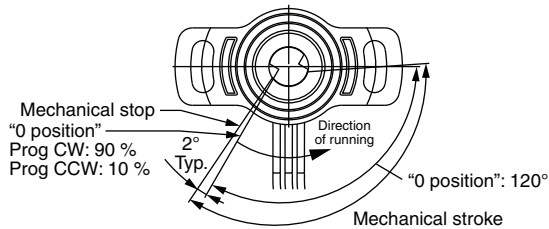

⑧ 981 HE Hollow D-Shaft  
CCW  
Shaft:  $\varnothing 8$   
Model: 981HE-1-x-x-W-x-8H01

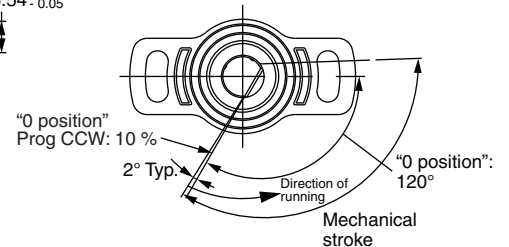



## **Disclaimer**

ALL PRODUCT, PRODUCT SPECIFICATIONS AND DATA ARE SUBJECT TO CHANGE WITHOUT NOTICE TO IMPROVE RELIABILITY, FUNCTION OR DESIGN OR OTHERWISE.

Vishay Intertechnology, Inc., its affiliates, agents, and employees, and all persons acting on its or their behalf (collectively, "Vishay"), disclaim any and all liability for any errors, inaccuracies or incompleteness contained in any datasheet or in any other disclosure relating to any product.

Vishay makes no warranty, representation or guarantee regarding the suitability of the products for any particular purpose or the continuing production of any product. To the maximum extent permitted by applicable law, Vishay disclaims (i) any and all liability arising out of the application or use of any product, (ii) any and all liability, including without limitation special, consequential or incidental damages, and (iii) any and all implied warranties, including warranties of fitness for particular purpose, non-infringement and merchantability.

Statements regarding the suitability of products for certain types of applications are based on Vishay's knowledge of typical requirements that are often placed on Vishay products in generic applications. Such statements are not binding statements about the suitability of products for a particular application. It is the customer's responsibility to validate that a particular product with the properties described in the product specification is suitable for use in a particular application. Parameters provided in datasheets and / or specifications may vary in different applications and performance may vary over time. All operating parameters, including typical parameters, must be validated for each customer application by the customer's technical experts. Product specifications do not expand or otherwise modify Vishay's terms and conditions of purchase, including but not limited to the warranty expressed therein.

Except as expressly indicated in writing, Vishay products are not designed for use in medical, life-saving, or life-sustaining applications or for any other application in which the failure of the Vishay product could result in personal injury or death. Customers using or selling Vishay products not expressly indicated for use in such applications do so at their own risk. Please contact authorized Vishay personnel to obtain written terms and conditions regarding products designed for such applications.

No license, express or implied, by estoppel or otherwise, to any intellectual property rights is granted by this document or by any conduct of Vishay. Product names and markings noted herein may be trademarks of their respective owners.