

GENERAL DESCRIPTION

The PSR05 has been specifically designed to protect sensitive components which are connected to data and transmission lines from overvoltages caused by ESD (electrostatic discharge), EFT (electrical fast transients), and lightning.

FEATURES

- Protects two I/O lines
- Max. peak pulse power : $P_{pp} = 350W$ at $t_p = 8/20$ us
- Low Capacitance : 5pF Typical
- Low clamping voltage
- IEC 61000-4-2, level 4 (ESD), $> \pm 15KV$ (air) ; $> \pm 8KV$ (contact)
- IEC 61000-4-5 (Lightning) , 5A (8/20 us)

APPLICATION

- USB Power & Data Line Protection
- Ethernet 10BaseT
- Video Line Protection
- T1/E1 secondary IC Side Protection
- Portable Electronics
- WAN/LAN Equipment

MECHANICAL DATA

- Case material: "Green" molding compound UL flammability classification 94V-0 (No Br, Sb, Cl)
- Terminals: Lead Free Plating (Matte Tin Finish), solderable per J-STD-002 and JESD22-B/02.
- Moisture Sensitivity: Level 1 per J-STD-020C
- Component in accordance to RoHS 2011/65/EU

MAXIMUM RATINGS AND ELECTRICAL CHARACTERISTICS

Ratings at 25°C ambient temperature unless otherwise specified.

ABSOLUTE RATINGS

PARAMETER	SYMBOL	VALUE	UNIT
Peak pulse power (8/20us waveform)	P_{PP}	350	W
Peak pulse current (8/20us waveform)	I_{PP}	12	A
Operating junction temperature range	T_J	-55 to +125	°C
Storage temperature range	T_{STG}	-55 to +150	°C
Soldering temperature, $t_{max} = 10s$	T_L	260	°C

ELECTRICAL CHARACTERISTICS

PARAMETER	TEST CONDITIONS	SYMBOL	MIN.	TYP.	MAX	UNIT
Reverse standoff voltage	--	V_{DRM}	--	--	5	V
Breakdown voltage	$I_t = 1mA$	V_{BR}	6	--	--	V
Reverse leakage current	$V_{DRM} = 5V$	I_{RM}	--	--	5	uA
Junction capacitance	$V_R = 0V, f = 1MHz,$ Between I/O pins and Ground	C_J	--	5	10	pF
	$V_R = 0V, f = 1MHz,$ Between I/O pins		--	3	5	
Clamping voltage	$I_{PP} = 1A$ (8/20 us)	V_C	--	--	8.8	V
	$I_{PP} = 25A$ (8/20 us)		--	--	18	

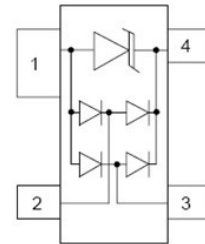
SOT-143

PIN ASSIGNMENT	
1	Ground
2, 3	Input Lines
4	VCC

RATING AND CHARACTERISTIC CURVES

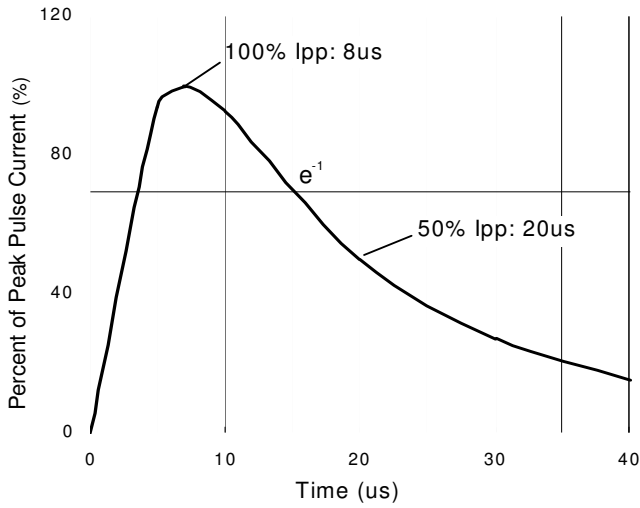

Figure 1. 8/20 us pulse waveform according to IEC 61000-4-5

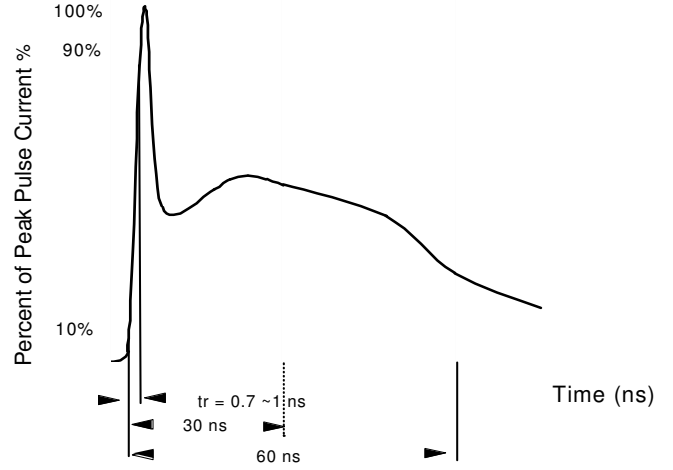

Figure 2. ESD pulse waveform according to IEC 61000-4-2

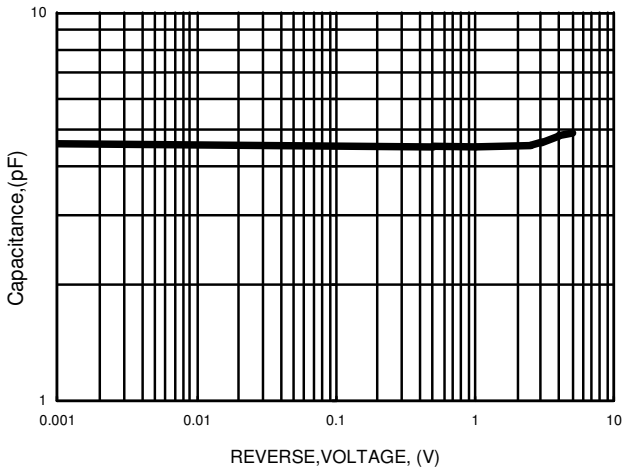

Figure 3. Typical Junction Capacitance

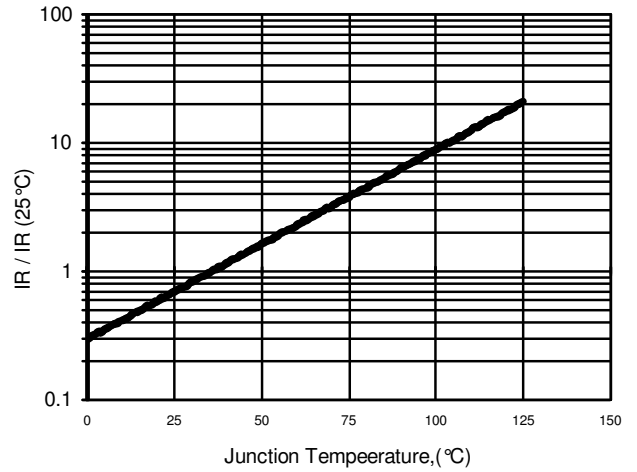

Figure 4. Reverse Leakage Current versus TJ

RATING AND CHARACTERISTIC CURVES

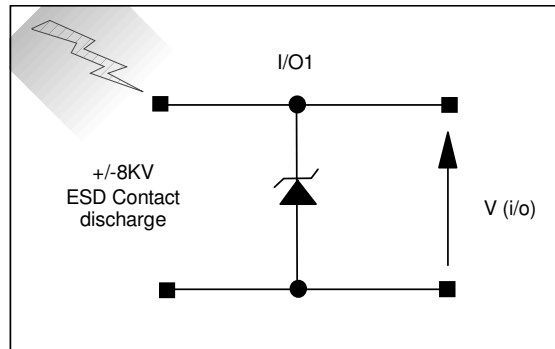

Figure 7. ESD Test Configuration

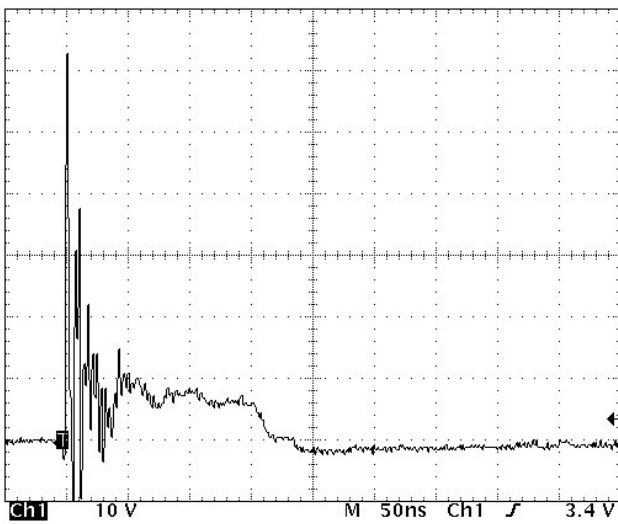

Figure 8. Clamped +8 kV ESD voltage waveform

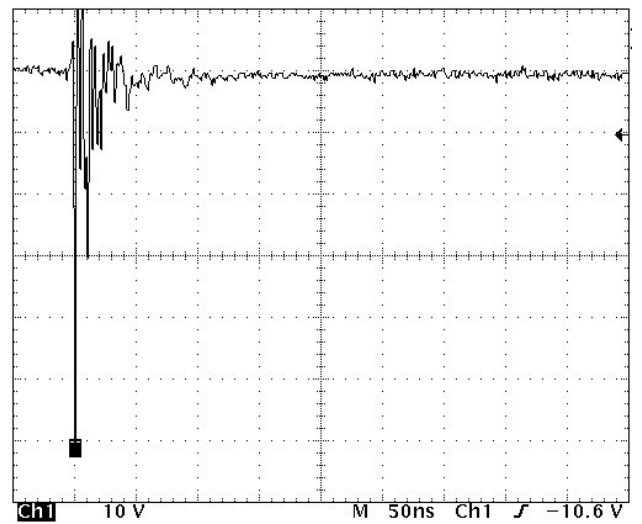
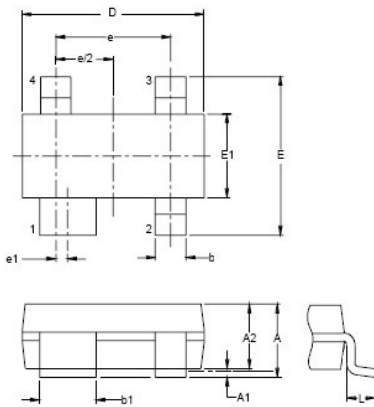

Figure 9. Clamped -8 kV ESD voltage waveform

PACKAGE OUTLINE

SOT-143



SOT-143		
DIM.	MIN.	MAX.
A	0.80	1.22
A1	0.013	0.15
A2	0.75	1.07
b	0.30	0.51
b1	0.76	0.94
D	2.80	3.04
E	2.10	2.64
E1	1.20	1.4
e	1.92 BSC	
e1	0.20 BSC	
L	0.40	0.60
All Dimensions in millimeter		

SOT-143 Soldering Pad Layout :

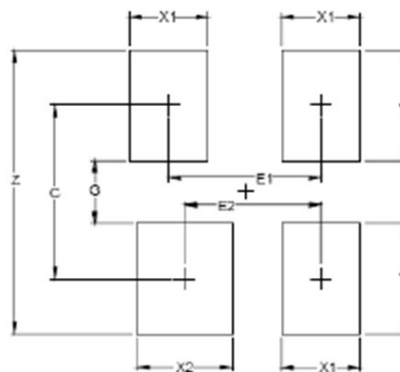

Dim.	Millimeters	Inches
C	(2.20)	(0.086)
E1	1.92	0.075
E2	1.72	0.067
G	0.80	0.031
X1	1.00	0.039
X2	1.20	0.047
Y	1.40	0.055
Z	3.60	0.141