

NPN Silicon Epitaxial Planar Transistor

FEATURES

- Low saturation.
- Complementary To FMMT591.
- Excellent H_{FE} Linearity.

APPLICATIONS

- Switching application.

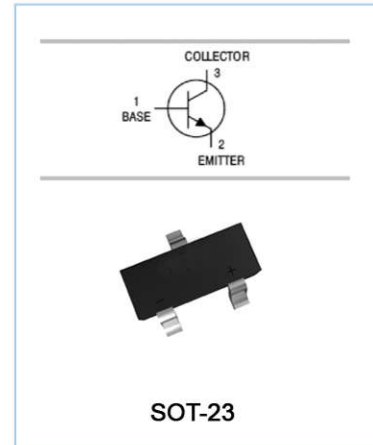

ORDERING INFORMATION

Type No.	Marking	Package Code
FMMT491	491	SOT-23

MAXIMUM RATING @ $T_a=25^\circ\text{C}$ unless otherwise specified

Symbol	Parameter	Value	Units
V_{CBO}	Collector-Base Voltage	80	V
V_{CEO}	Collector-Emitter Voltage	60	V
V_{EBO}	Emitter-Base Voltage	5	V
I_C	Collector Current -Continuous	1000	mA
P_C	Collector Dissipation	500	mW
T_j, T_{stg}	Junction and Storage Temperature	-55~150	$^\circ\text{C}$



ELECTRICAL CHARACTERISTICS @ $T_a=25^\circ\text{C}$ unless otherwise specified

Parameter	Symbol	Test conditions	MIN	TYP	MAX	UNIT
Collector-base breakdown voltage	$V_{(BR)CBO}$	$I_C=100\mu\text{A}, I_E=0$	80			V
Collector-emitter breakdown voltage	$V_{(BR)CEO}$	$I_C=10\text{mA}, I_B=0$	60			V
Emitter-base breakdown voltage	$V_{(BR)EBO}$	$I_E=100\mu\text{A}, I_C=0$	5			V
Collector cut-off current	I_{CBO}	$V_{CB}=60\text{V}, I_E=0$			0.1	μA
Emitter cut-off current	I_{EBO}	$V_{EB}=4\text{V}, I_C=0$			0.1	μA
DC current gain	h_{FE}	$V_{CE}=5\text{V}, I_C=1\text{mA}$	100			
		$V_{CE}=5\text{V}, I_C=500\text{mA}$	100		300	
		$V_{CE}=5\text{V}, I_C=1\text{A}$	80			
		$V_{CE}=5\text{V}, I_C=2\text{A}$	30			
Collector-emitter saturation voltage	$V_{CE(sat)}$	$I_C=500\text{mA}, I_B=50\text{mA}$ $I_C=1\text{A}, I_B=100\text{mA}$			0.25 0.5	V
Base-emitter saturation voltage	$V_{BE(sat)}$	$I_C=1\text{A}, I_B=100\text{mA}$			1.1	V
Transition frequency	f_T	$V_{CE}=10\text{V}, I_C=50\text{mA}$ $f=100\text{MHz}$	150			MHz
Collector output capacitance	C_{ob}	$V_{CB}=10\text{V}, f=1\text{MHz}$			10	pF



TYPICAL CHARACTERISTICS @ Ta=25°C unless otherwise specified

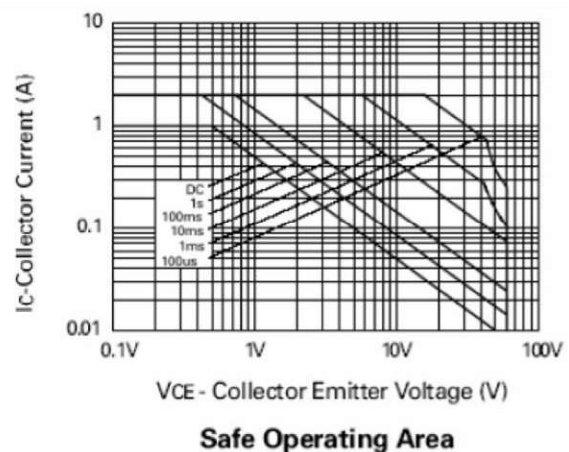
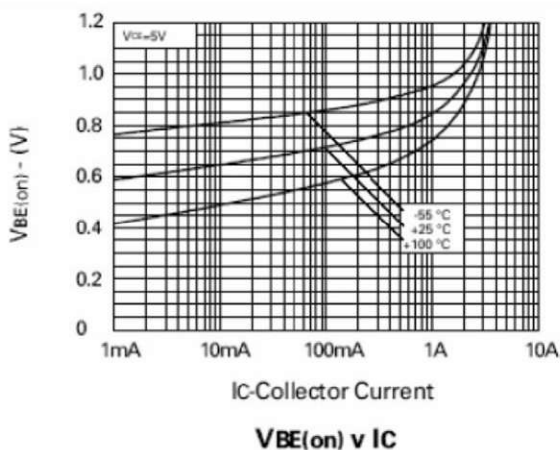
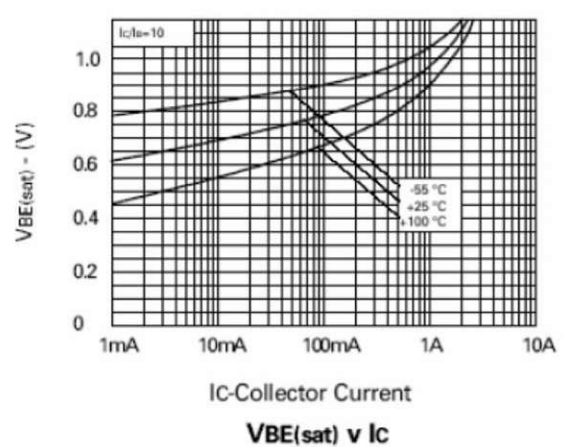
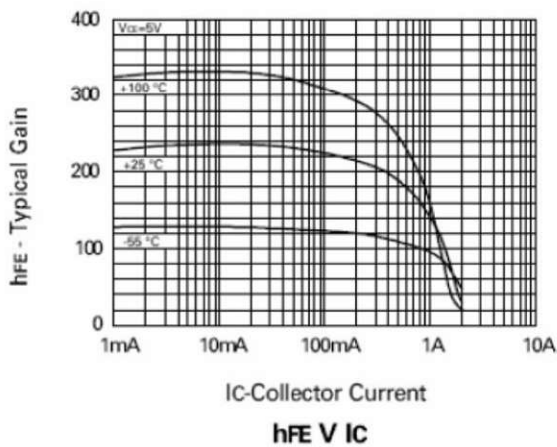
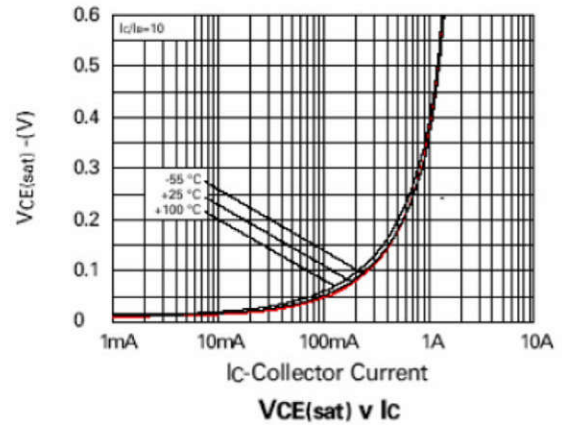
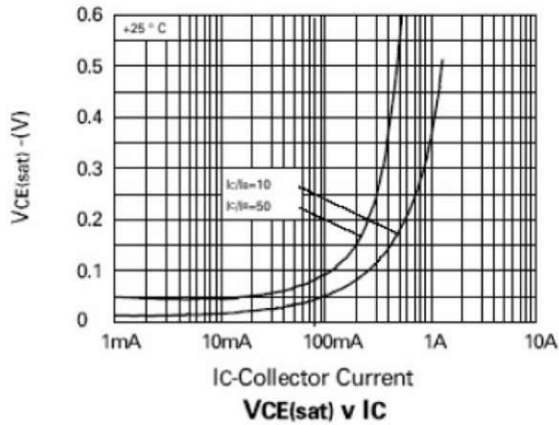

PACKAGE OUTLINE

Plastic surface mounted package

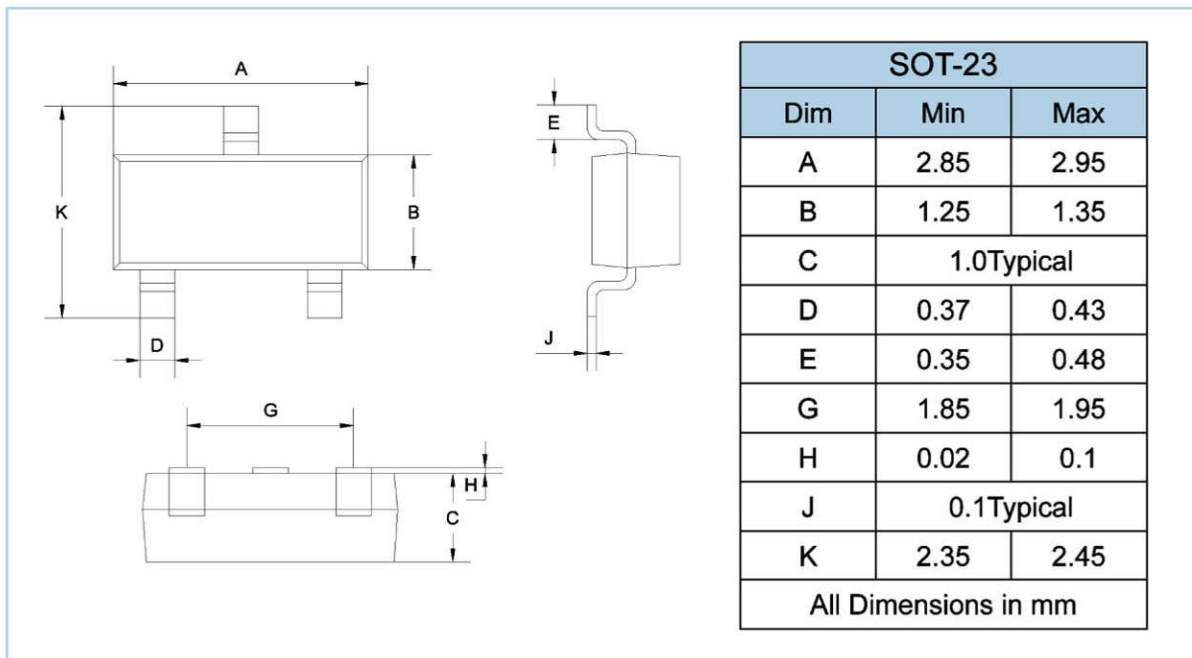

SOLDERING FOOTPRINT

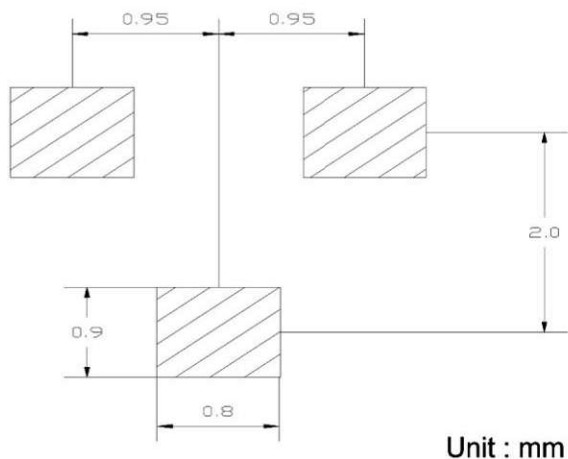

PACKAGE INFORMATION

Device	Package	Shipping
FMMT491	SOT-23	3000/Tape&Reel

