

APPROVAL SHEET

**WK25S WK20S WK10S WK12S WK08S
WK06S**

±5%, ±10%, ±20%

Thick Film Power Surge Chip Resistors

Size 2512 , 2010 , 1210, 1206 , 0805, 0603

*Contents in this sheet are subject to change without prior notice.

FEATURE

1. High power rating and compact size
2. High reliability and stability
3. Reduced size of final equipment
4. High anti-surge protection
5. Halogen free

APPLICATION

- Power supply
- Measurement instrument
- Automotive industry
- Medical or Military equipment

DESCRIPTION

The resistors are constructed in a high grade ceramic body (aluminum oxide). Internal electrodes are added at each end and connected by a resistive paste that is applied to the top surface of the substrate. The composition of the paste is adjusted to request resistance to nominal value within tolerance which controlled by printing process in this resistive layer.

The resistive layer is covered with a protective coat. Finally, the two external end terminations are added. For ease of soldering the outer layer of these end terminations is a Tin (Pb free) alloy.

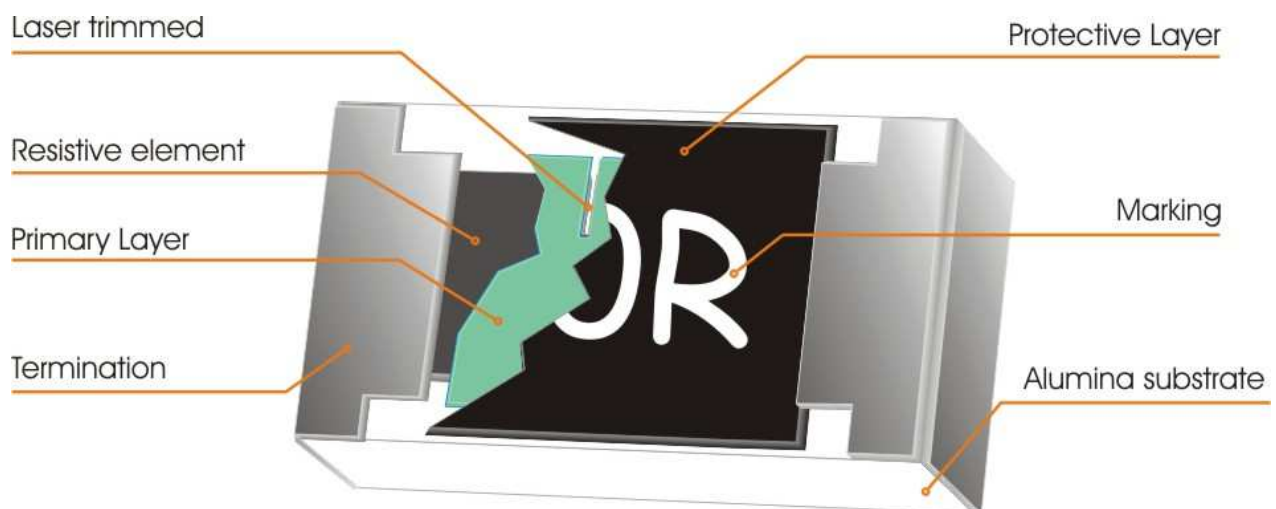

Fig 1. Construction of Chip-R WKxxS

QUICK REFERENCE DATA

Item	General Specification					
Series No.	WK25S	WK20S	WK10S	WK12S	WK08S	WK06S
Size code	2512(6432)	2010 (5025)	1210 (3225)	1206 (3216)	0805 (2012)	0603 (1608)
Resistance Tolerance	±5% ±10% ±20% (E24)					
Resistance Range	0.27Ω ~ 22MΩ					1Ω ~ 1MΩ
TCR (ppm/°C)	± 200 ppm /°C					10 - 1MΩ: ± 100 ppm /°C
1.1MΩ ~ 22MΩ	± 100 ppm /°C					1 - 9.1Ω: ± 200 ppm /°C
1Ω ~ 1MΩ	± 200 ppm /°C					
0.27Ω ~ 0.91Ω						
Max. dissipation at T _{amb} =70°C	1 W	3/4W	1/2W	1/3W	1/4W	1/4W
Max. Operation Voltage	200V	200V	200V	200V	150V	150V
Max. Overload Voltage	400V	400V	400V	400V	300V	300V
Operation temperature	- 55 ~ +155°C					

Note :

- This is the maximum voltage that may be continuously supplied to the resistor element, see "IEC publication 60115-8"
- Max. Operation Voltage : So called RCWV (Rated Continuous Working Voltage) is determined by

$$RCWV = \sqrt{\text{Rated Power} \times \text{Resistance Value}} \text{ or Max. RCWV listed above, whichever is lower.}$$

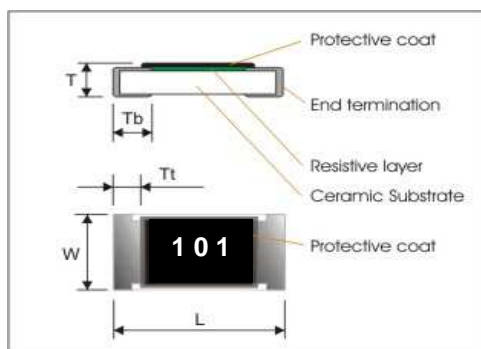
MECHANICAL DATA(unit : mm)

Symbol	WK25S	WK20S	WK10S	WK12S	WK08S	WK06S
L	6.30±0.15	5.00±0.15	3.10±0.15	3.10±0.15	2.00 ± 0.10	1.60 ± 0.10
W	3.20±0.15	2.50±0.15	2.50±0.15	1.60±0.15	1.25 ± 0.10	0.80 +0.15/-0.05
T	0.55±0.15	0.55±0.15	0.55±0.15	0.55±0.10	0.55 ± 0.10	0.45 ± 0.10
Tt	0.30±0.15	0.30±0.15	0.30±0.20	0.30±0.20	0.30 ± 0.20	0.30 ± 0.20
Tb	0.60±0.20	0.60±0.20	0.50±0.25	0.50±0.25	0.40 ± 0.20	0.30 ± 0.10

MARKING

1. Each resistor is marked with a three-digit code on the protective coating to designate the nominal resistance value.

Single pulse limiting power chart

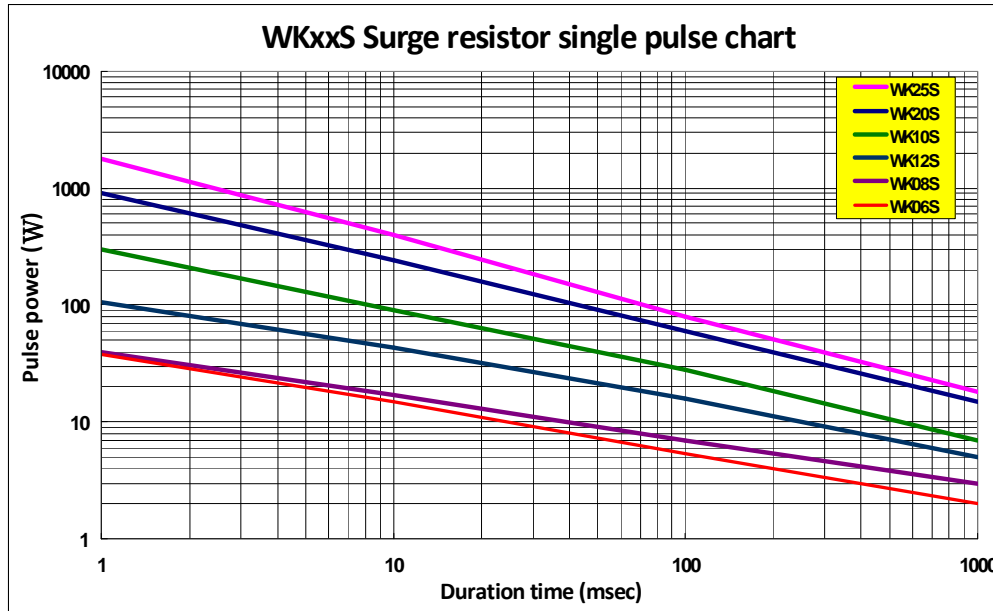

De-rating curve

The power that the resistor can dissipate depends on the operating temperature; see Fig.2

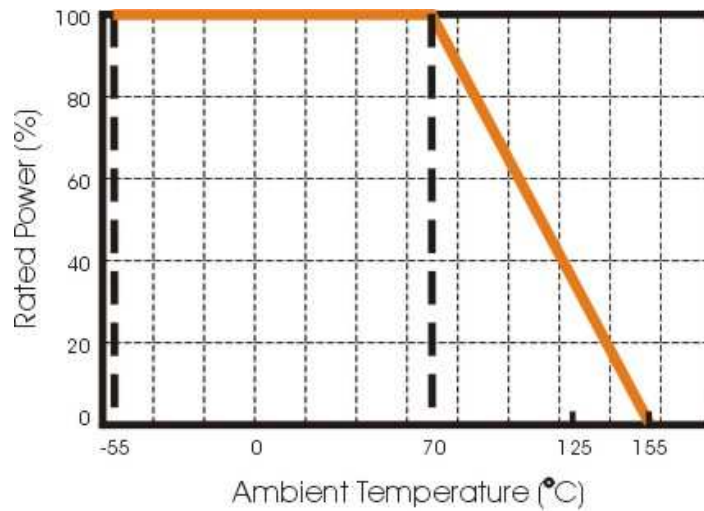

Fig.2 Maximum dissipation in percentage of rated power
As a function of the ambient temperature

MOUNTING

Due to their rectangular shapes and small tolerances, Surface Mountable Resistors are suitable for handling by automatic placement systems.

Chip placement can be on ceramic substrates and printed-circuit boards (PCBs).

Electrical connection to the circuit is by individual soldering condition.

The end terminations guarantee a reliable contact.

SOLDERING CONDITION

The robust construction of chip resistors allows them to be completely immersed in a solder bath of 260°C for 10 seconds. Therefore, it is possible to mount Surface Mount Resistors on one side of a PCB and other discrete components on the reverse (mixed PCBs).

Surface Mount Resistors are tested for solderability at 235°C during 2 seconds. The test condition for no leaching is 260°C for 30 seconds. Typical examples of soldering processes that provide reliable joints without any damage are given in Fig 3.

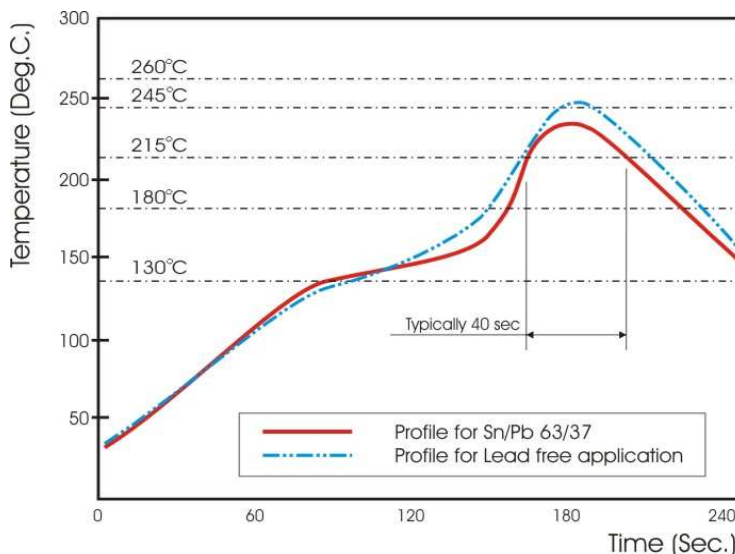

Fig 3. Infrared soldering profile for Chip Resistors

CATALOGUE NUMBERS

The resistors have a catalogue number starting with .

WK25	S	472_	J	T	L
Size code	Type code	Resistance code	Tolerance	Packaging code	Termination code
WK25 : 2512 WK20 : 2010 WK10 : 1210 WK12 : 1206 WK08 : 0805 WK06 : 0603	S : surge	E24 : 3 significant digits followed by no. of zeros and a blank 472 = 4K7ohm R820 = 0.82ohm	J: ±5% K: ±10% M: ±20%	T : 7" Reeled taping	L = Sn base (lead free)

Taping quantity

- 1210, 1206, 0805, 0603 Chip resistors 5,000 pcs paper tape per reel.
- 2010, 2512 Chip resistors 4,000 pcs plastic tape per reel.

TEST AND REQUIREMENTS(JIS C 5201-1 : 1998)

TEST	PROCEDURE	REQUIREMENT
Temperature Coefficient of Resistance(T.C.R) Clause 4.8	Natural resistance change per change in degree centigrade. $\frac{R_2 - R_1}{R_1(t_2 - t_1)} \times 10^6 \text{ (ppm/}^\circ\text{C)}$ $t_1 : 20^\circ\text{C}+5^\circ\text{C}-1^\circ\text{C}$ R_1 : Resistance at reference temperature R_2 : Resistance at test temperature	Refer to "QUICK REFERENCE DATA"
Short time overload (S.T.O.L) Clause 4.13	Permanent resistance change after a 2 second application of a voltage 2.5 times RCWV or the maximum overload voltage specified in the above list, whichever is less.	$\Delta R/R$ max. $\pm(1\%+0.05\Omega)$ no visible damage
Resistance to soldering heat(R.S.H) Clause 4.18	Un-mounted chips completely immersed for 10 ± 1 second in a solder bath at $260^\circ\text{C} \pm 5^\circ\text{C}$	no visible damage $\Delta R/R$ max. $\pm(1\%+0.05\Omega)$
Solderability Clause 4.17	Un-mounted chips completely immersed for 2 ± 0.5 second in a solder bath at $235^\circ\text{C} \pm 5^\circ\text{C}$	good tinning (>95% covered) no visible damage
Temperature cycling Clause 4.19	30 minutes at $-55^\circ\text{C} \pm 3^\circ\text{C}$, 2~3 minutes at $20^\circ\text{C}+5^\circ\text{C}-1^\circ\text{C}$, 30 minutes at $+155^\circ\text{C} \pm 3^\circ\text{C}$, 2~3 minutes at $20^\circ\text{C}+5^\circ\text{C}-1^\circ\text{C}$, total 5 cycles	no visible damage $\Delta R/R$ max. $\pm(1\%+0.05\Omega)$
Load life (endurance) Clause 4.25	$70 \pm 2^\circ\text{C}$, 1000 hours, loaded with RCWV or V_{max} , 1.5 hours on and 0.5 hours off	$\Delta R/R$ max. $\pm(5\%+0.1\Omega)$ no visible damage
Load life in Humidity Clause 4.24	1000 hours, at rated continuous working voltage in humidity chamber controller at $40^\circ\text{C} \pm 2^\circ\text{C}$ and 90~95% relative humidity, 1.5hours on and 0.5 hours off	$\Delta R/R$ max. $\pm(5\%+0.1\Omega)$ no visible damage
Endurance at high temperature Clause 4.25.3	155°C , no load, 1000hours	$\Delta R/R$ max. $\pm(5\%+0.1\Omega)$ no visible damage
Bending strength Clause 4.33	Resistors mounted on a 90mm glass epoxy resin PCB(FR4); 2512, 2010 bending : 1 mm, once for 10 seconds 1210, 1206, 0805 bending : 3 mm, once for 10 seconds	$\Delta R/R$ max. $\pm(1\%+0.05\Omega)$
Adhesion Clause 4.32	Pressurizing force: 5N, Test time: 10 ± 1 sec.	No remarkable damage or removal of the terminations
Insulation Resistance Clause 4.6	Apply the maximum overload voltage (DC) for 1 minute	$R \geq 1\text{G}\Omega$
Dielectric Withstand Voltage Clause 4.7	Apply the maximum overload voltage (AC) for 1 minute	No breakdown or flashover

PACKAGING

Tape specifications (unit :mm)

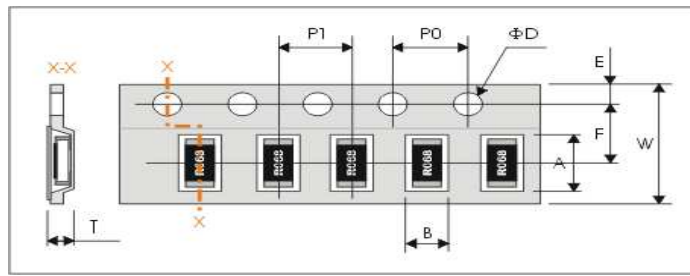

Series No.	A	B	W	F	E
WK25S	6.90±0.20	3.60±0.20	12.00±0.30	5.50±0.05	1.75±0.10
WK20S	5.50±0.20	3.100±0.20			
WK10S	3.50±0.20	2.85±0.20	8.00±0.30	3.50±0.05	1.75±0.10
WK12S	3.60±0.20	2.00±0.15	8.00±0.20	3.50±0.05	1.75±0.10
WK08S	2.50±0.20	1.65±0.15			
WK06S	1.90±0.20	1.15±0.15	8.00±0.30	3.50±0.05	1.75±0.10

Series No.	P1	P0	ΦD	T
WK25S	4.00±0.10	4.00±0.10	Φ1.50 ^{+0.1} _{-0.0}	1.1±0.15
WK20S				1.0±0.20
WK10S				Max. 1.0
WK12S				Max. 1.0
WK08S				Max. 1.0
WK06S				Max. 0.8

Reel dimensions

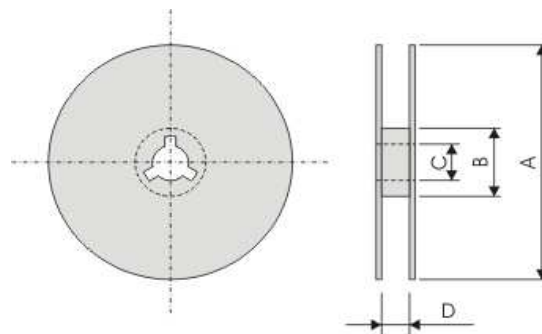

Reel / Tape	A	B	C	D
7" reel for 8mm tape	Φ180.0+0/-1.5	Φ60.0+1/0	13.0±0.2	9+1.0/0
7" reel for 12mm tape				13+1.0/0

Taping quantity

- 1210, 1206 0805, 0603 Chip resistors 5,000 pcs paper tape per reel.
- 2010, 2512 Chip resistors 4,000 pcs plastic tape per reel.