

## Specifications

Current rating:3A AC,DC  
Voltage rating:250V AC,DC  
Temperature range:-40°C~+105°C  
Contact resistance:10mΩMax.  
Insulation resistance:1000MΩMin.  
Withstanding voltage:800V AC/minute  
\*Compliant with RoHS and REACH\*  
\*Meet the HF/Halogen Free,need to customize\*  
\*Contact CJT for details\*

## Standards



## Assembly layout

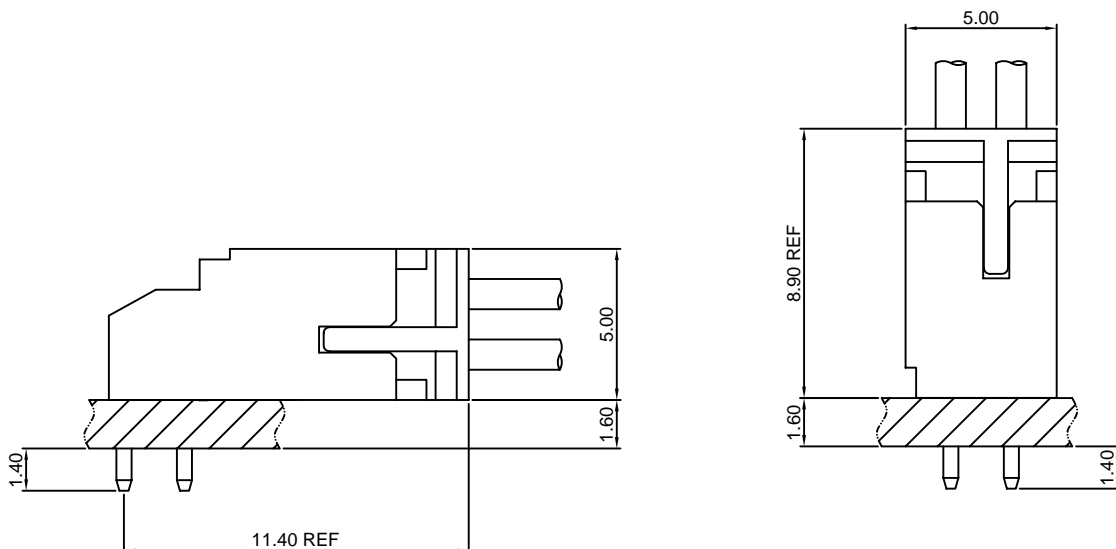

**A2006-T**

2.00mm pitch Crimp Terminal

**Reference Informations:**

\*Used in CJT A2006H,HA-2xXP,A2012H-XP series Housing

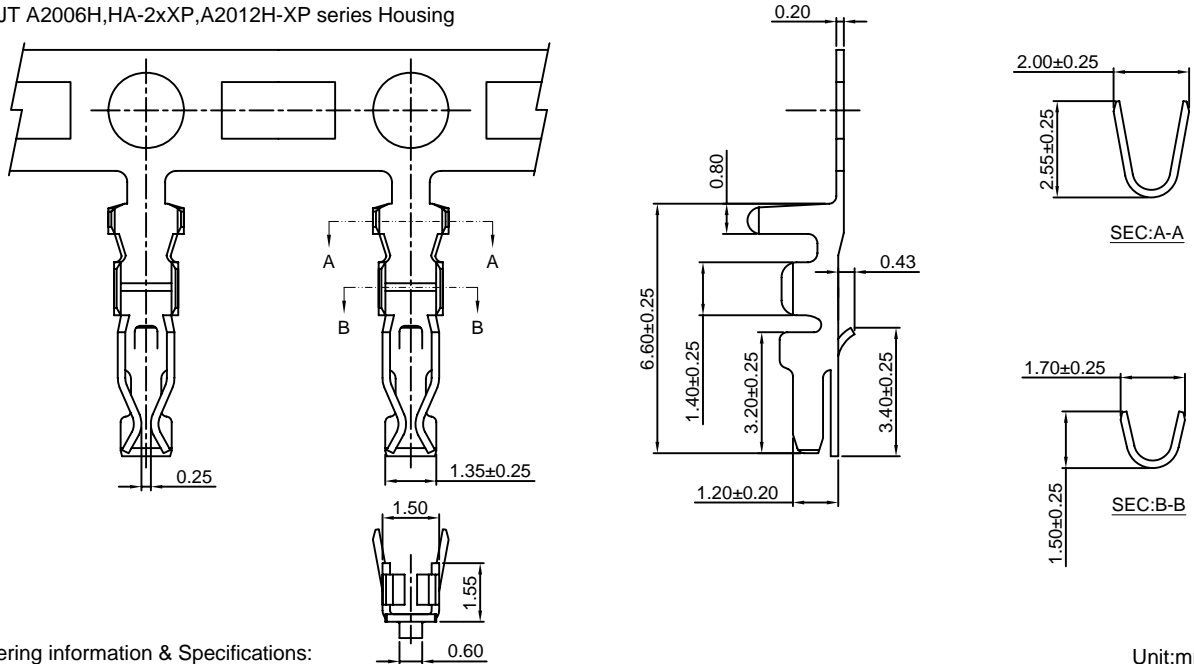

Ordering information & Specifications:

Unit:mm

Part NO.	Wire Range	Insulation O.D.	Material	Finish	Qty/reel
A2006-TP	AWG#22-#28	1.50mm(max)	Phosphor Bronze	Tin over Nickel	10,000 PCS
A2006-GP	AWG#22-#28	1.50mm(max)	Phosphor Bronze	Gold over flash	10,000 PCS

Optional Gold plating available but MOQ requested

**A2006-T-B**

2.00mm pitch Crimp Terminal

**Reference Informations:**

\*Used in CJT A2006HB-2xXP series Housing

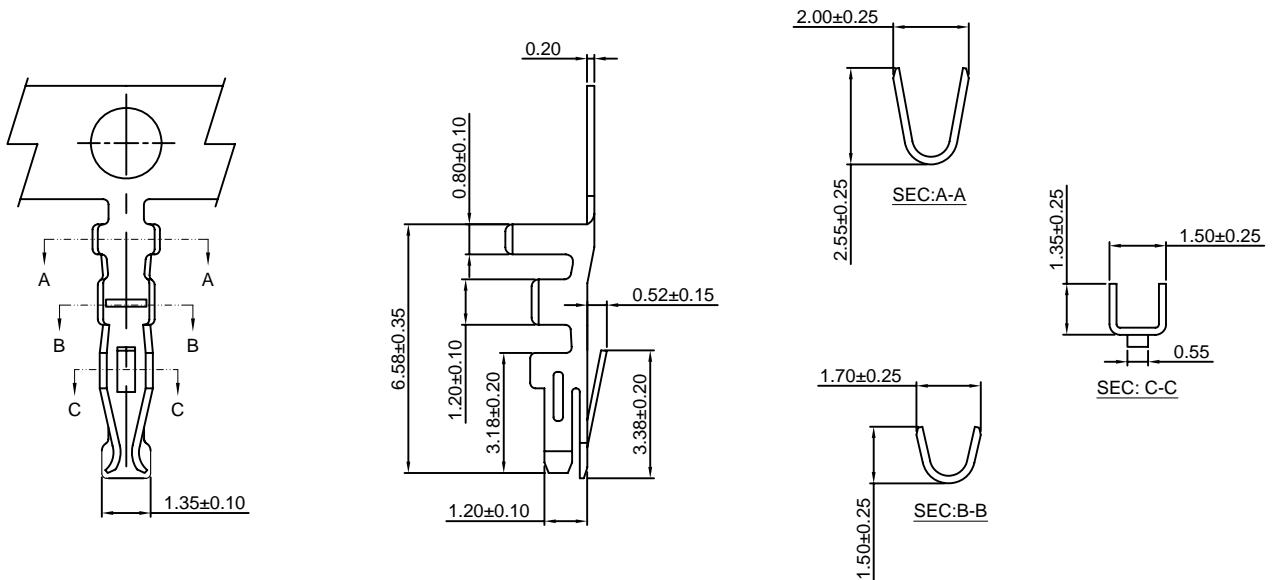

Ordering information & Specifications:

Unit:mm

Part NO.	Wire Range	Insulation O.D.	Material	Finish	Qty/reel
A2006-TP-B	AWG#22-#28	1.50mm(max)	Phosphor Bronze	Tin over Nickel	10,000 PCS
A2006-GP-B	AWG#22-#28	1.50mm(max)	Phosphor Bronze	Gold over flash	10,000 PCS

Optional Gold plating available but MOQ requested

# A2006-T-U

2.00mm pitch Crimp Terminal

#### Reference Informations:

\*Used in CJT A2006HU-2xXP series Housing

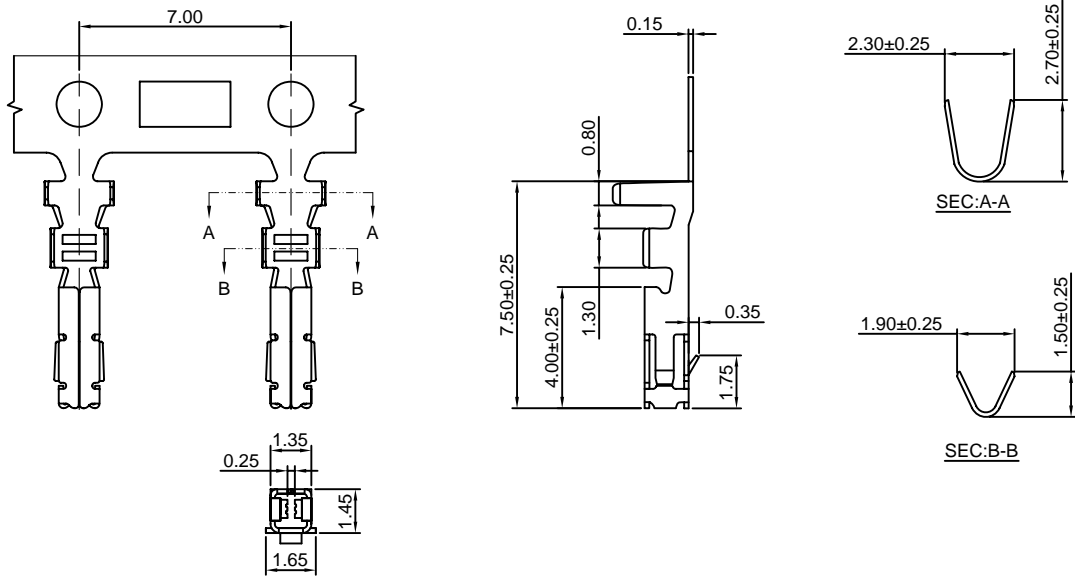

Ordering information & Specifications:

Unit:mm

Part NO.	Wire Range	Insulation O.D.	Material	Finish	Qty/reel
A2006-TP-U	AWG#22-#28	1.50mm(max)	Phosphor Bronze	Tin over Nickel	10,000 PCS
A2006-GP-U	AWG#22-#28	1.50mm(max)	Phosphor Bronze	Gold over flash	10,000 PCS

Optional Gold plating available but MOQ requested

# A2006H-2xXP

2.00mm pitch Dual Row Housing

#### Reference Informations:

\*Material:Nylon 66,UL94V-0

\*Suitable CJT A2006-T series Terminal

\*Mates with CJT A2006WV,WR,WV-S,WV-S-F-2xXP series Dual Row Wafer

\*Color:White

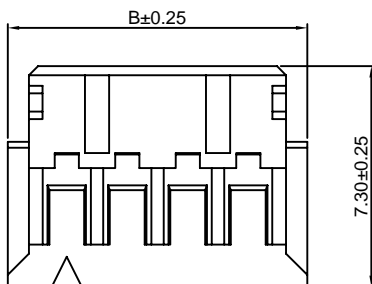
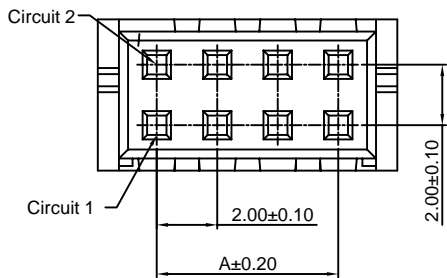
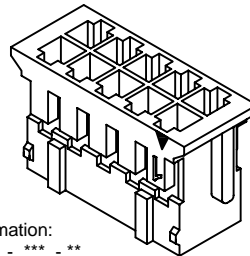

#### Ordering Information:

A2006H-2xXP - \*\*\* - \*\*  
1 2 3

1.Part No.

2.Material:

(Blank):Nylon 66,UL94V-0

GWT:Nylon 66,UL94V-0,GWT 750 °C

3.Color:

(Blank):White

BK:Black

RD:Red

YL:Yellow

BL:Blue

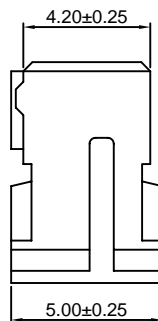

#### Ordering Information & Dimensions:

PART NO.	Dimensions	
	A	B
2x2P	2.00	5.90
2x3P	4.00	7.90
2x4P	6.00	9.90
2x5P	8.00	11.90
2x6P	10.00	13.90
2x7P	12.00	15.90
2x8P	14.00	17.90
2x9P	16.00	19.90
2x10P	18.00	21.90
2x11P	20.00	23.90
2x12P	22.00	25.90
2x13P	24.00	27.90
2x14P	26.00	29.90
2x15P	28.00	31.90
2x16P	30.00	33.90
2x17P	32.00	35.90
2x18P	34.00	37.90
2x19P	36.00	39.90
2x20P	38.00	41.90
2x21P	40.00	43.90
2x22P	42.00	45.90
2x23P	44.00	47.90
2x24P	46.00	49.90
2x25P	48.00	51.90

Unit: mm

## A2006HA-2xXP

2.00mm pitch Dual Row Housing

### Reference Informations:

- \*Material:Nylon 66,UL94V-0
- \*Suitable CJT A2006-T series Terminal
- \*Mates with CJT A2006WVA,WRA-2xXP series Dual Row Wafer
- \*Color:White

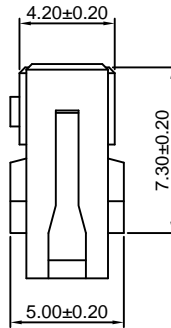
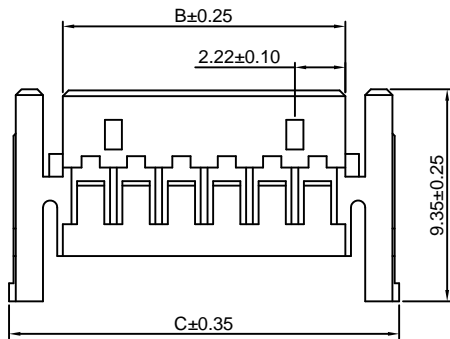
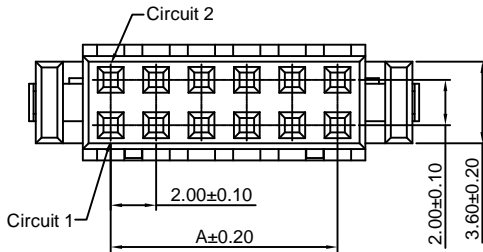

### Ordering Information:

A2006HA-2xXP - \*\*\* - \*\*  
1 2 3

- 1.Part No.
- 2.Material:  
(Blank):Nylon 66,UL94V-0  
GWT:Nylon 66,UL94V-0,GWT 750 °C
- 3.Color:  
(Blank):White  
BK:Black  
RD:Red  
YL:Yellow  
BL:Blue

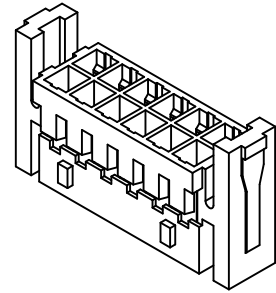

### Ordering Information & Dimensions:

PART NO.	Dimensions		
	A	B	C
2x3P	4.00	6.45	11.60
2x4P	6.00	8.45	13.60
2x5P	8.00	10.45	15.60
2x6P	10.00	12.45	17.60
2x7P	12.00	14.45	19.60
2x8P	14.00	16.45	21.60
2x9P	16.00	18.45	23.60
2x10P	18.00	20.45	25.60
2x11P	20.00	22.45	27.60
2x12P	22.00	24.45	29.60
2x13P	24.00	26.45	31.60
2x14P	26.00	28.45	33.60
2x15P	28.00	30.45	35.60
2x16P	30.00	32.45	37.60
2x17P	32.00	34.45	39.60
2x18P	34.00	36.45	41.60
2x19P	36.00	38.45	43.60
2x20P	38.00	40.45	45.60

Unit: mm

## A2006HB-2xXP

2.00mm pitch Dual Row Housing

### Reference Informations:

- \*Material:Nylon 66,UL94V-0
- \*Suitable CJT A2006-T-B series Terminal
- \*Mates with CJT A2006WVB ,WRB-2xXP series Dual Row Wafer
- \*Color:White

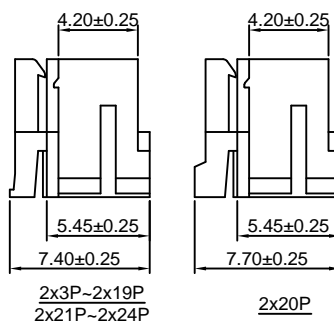
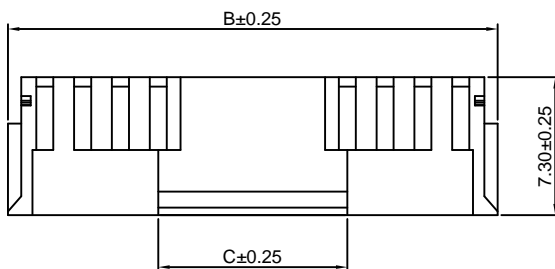
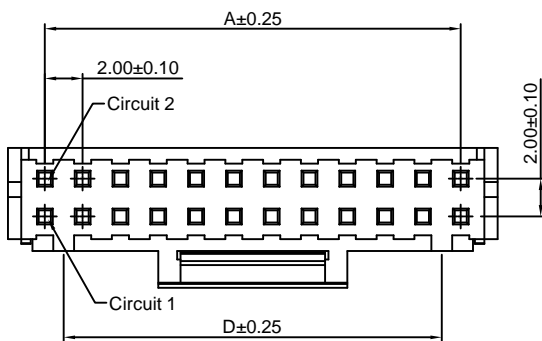

### Ordering Information:

A2006HB-2xXP - \*\*\* - \*\*  
1 2 3

- 1.Part No.
- 2.Material:  
(Blank):Nylon 66,UL94V-0  
GWT:Nylon 66,UL94V-0,GWT 750 °C
- 3.Color:  
(Blank):White  
BK:Black  
RD:Red  
YL:Yellow  
BL:Blue

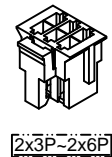
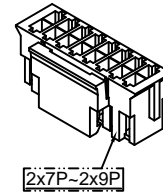
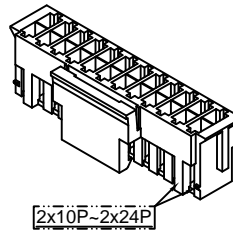

### Ordering Information & Dimensions:

PART NO.	Dimensions			
	A	B	C	D
2x3P	4.00	7.90	5.25	----
2x4P	6.00	9.90	7.35	----
2x5P	8.00	11.90	9.35	----
2x6P	10.00	13.90	10.00	----
2x7P	12.00	15.90	10.00	12.00
2x8P	14.00	17.90	10.00	14.00
2x9P	16.00	19.90	10.00	16.00
2x10P	18.00	21.90	10.00	18.00
2x11P	20.00	23.90	10.00	20.00
2x12P	22.00	25.90	10.00	22.00
2x13P	24.00	27.90	10.00	24.00
2x14P	26.00	29.90	10.00	26.00
2x15P	28.00	31.90	10.00	28.00
2x16P	30.00	33.90	10.00	30.00
2x17P	32.00	35.90	10.00	32.00
2x18P	34.00	37.90	10.00	34.00
2x19P	36.00	39.90	10.00	36.00
2x20P	38.00	41.90	15.00	38.00
2x21P	40.00	43.90	10.00	40.00
2x22P	42.00	45.90	10.00	42.00
2x23P	44.00	47.90	10.00	44.00
2x24P	46.00	49.90	10.00	46.00

Unit: mm

### A2006HU-2xXP

2.00mm pitch Dual Row Housing

**Reference Informations:**

- \*Material:Nylon 66,UL94V-0
- \*Suitable CJT A2006-T-U series Terminal
- \*Mates with CJT A2006WVU,WRU-2xXP series Dual Row Wafer
- \*Color:Natural

**Ordering Information:**

A2006HU-2xXP - \*\*\* - \*\*  
 1                    2                    3

- 1.Part No.
- 2.Material:  
 (Blank):Nylon 66,UL94V-0  
 GWT:Nylon 66,UL94V-0,GWT 750 °C
- 3.Color:  
 (Blank):Natural  
 BK:Black  
 RD:Red  
 YL:Yellow  
 BL:Blue

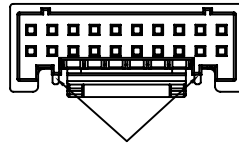
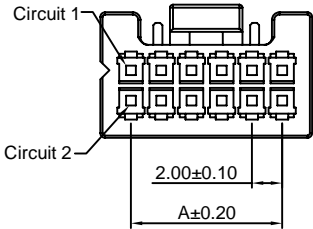
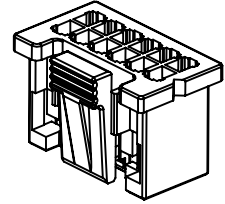

2x4P~2x7P Without Guide bulge  
 2x8P~2x20P With Guide bulge

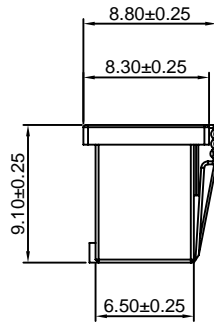
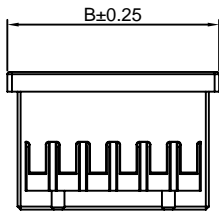

**Ordering Information & Dimensions:**

PART NO.	Dimensions	
	A	B
2x4P	6.00	10.00
2x5P	8.00	12.00
2x6P	10.00	14.00
2x7P	12.00	16.00
2x8P	14.00	18.00
2x9P	16.00	20.00
2x10P	18.00	22.00
2x11P	20.00	24.00
2x12P	22.00	26.00
2x13P	24.00	28.00
2x14P	26.00	30.00
2x15P	28.00	32.00
2x16P	30.00	34.00
2x17P	32.00	36.00
2x18P	34.00	38.00
2x19P	36.00	40.00
2x20P	38.00	42.00

Unit: mm

### A2006WV-2xXP

2.00mm pitch 180° Dual Row Wafer

**Reference Informations:**

- \*Material:Pin:Brass/Tin over Nickel  
 Insulator:Nylon 66,UL94V-0
- \*Mates with CJT A2006H-2xXP,A2009H-2xXP series Dual Row Housing
- \*Color:Ivory

**Ordering Information:**

A2006WV-2xXP - \*\*\* - \*\* - \*\*  
 1                    2                    3                    4

- 1.Part No.
- 2.Material:  
 (Blank):Nylon 66,UL94V-0  
 GWT:Nylon 66,UL94V-0,GWT 750 °C
- 3.Color:  
 (Blank):Ivory  
 BK:Black  
 RD:Red  
 YL:Yellow  
 BL:Blue
- 4.Finish:  
 (Blank):Tin over Nickel  
 G:Gold over Nickel

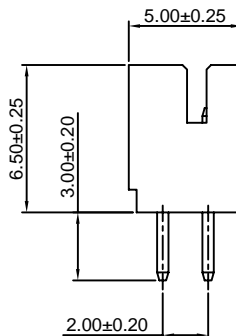
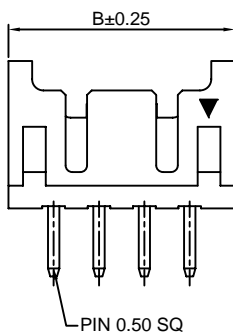
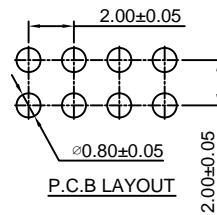
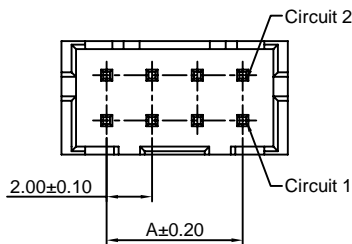

**Ordering Information & Dimensions:**

PART NO.	Dimensions	
	A	B
2x2P	2.00	5.90
2x3P	4.00	7.90
2x4P	6.00	9.90
2x5P	8.00	11.90
2x6P	10.00	13.90
2x7P	12.00	15.90
2x8P	14.00	17.90
2x9P	16.00	19.90
2x10P	18.00	21.90
2x11P	20.00	23.90
2x12P	22.00	25.90
2x13P	24.00	27.90
2x14P	26.00	29.90
2x15P	28.00	31.90
2x16P	30.00	33.90
2x17P	32.00	35.90
2x18P	34.00	37.90
2x19P	36.00	39.90
2x20P	38.00	41.90
2x21P	40.00	43.90
2x22P	42.00	45.90
2x23P	44.00	47.90
2x24P	46.00	49.90
2x25P	48.00	51.90

Unit: mm

### A2006WR-2xXP

2.00mm pitch 90° Dual Row Wafer

**Reference Informations:**

- \*Material: Pin: Brass/Tin over Nickel  
Insulator: Nylon 66, UL94V-0
- \*Mates with CJT A2006H-2xXP, A2009H-2xXP series Dual Row Housing
- \*Color: Ivory

**Ordering Information:**

A2006WR-2xXP - <sup>\*\*\*</sup>/<sub>1</sub> - <sup>\*\*</sup>/<sub>2</sub> - <sup>\*\*</sup>/<sub>3</sub> - <sup>\*\*</sup>/<sub>4</sub>

1. Part No.
2. Material:  
(Blank): Nylon 66, UL94V-0  
GWT: Nylon 66, UL94V-0, GWT 750°C
3. Color:  
(Blank): Ivory  
BK: Black  
RD: Red  
YL: Yellow  
BL: Blue
4. Finish:  
(Blank): Tin over Nickel  
G: Gold over Nickel

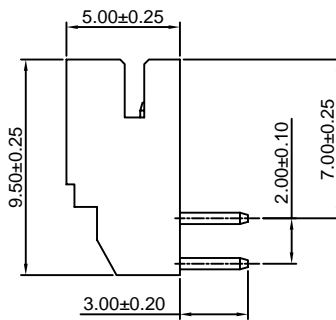
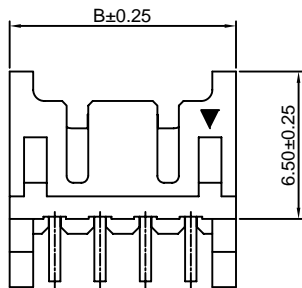
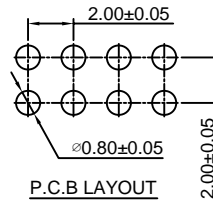
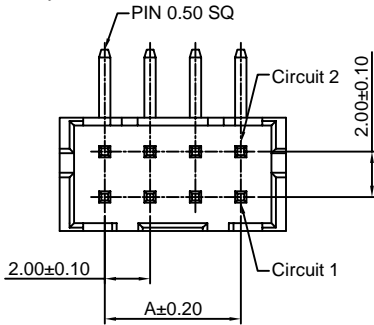

**Ordering Information & Dimensions:**

PART NO.	Dimensions	
	A	B
2x2P	2.00	5.90
2x3P	4.00	7.90
2x4P	6.00	9.90
2x5P	8.00	11.90
2x6P	10.00	13.90
2x7P	12.00	15.90
2x8P	14.00	17.90
2x9P	16.00	19.90
2x10P	18.00	21.90
2x11P	20.00	23.90
2x12P	22.00	25.90
2x13P	24.00	27.90
2x14P	26.00	29.90
2x15P	28.00	31.90
2x16P	30.00	33.90
2x17P	32.00	35.90
2x18P	34.00	37.90
2x19P	36.00	39.90
2x20P	38.00	41.90
2x21P	40.00	43.90
2x22P	42.00	45.90
2x23P	44.00	47.90
2x24P	46.00	49.90
2x25P	48.00	51.90

Unit: mm

### A2006WVA-2xXP

2.00mm pitch 180° Dual Row Wafer

**Reference Informations:**

- \*Material: Pin: Brass/Tin over Nickel  
Insulator: Nylon 66, UL94V-0
- \*Mates with CJT A2006HA-2xXP series Dual Row Housing
- \*Color: Ivory

**Ordering Information:**

A2006WVA-2xXP - <sup>\*\*\*</sup>/<sub>1</sub> - <sup>\*\*</sup>/<sub>2</sub> - <sup>\*\*</sup>/<sub>3</sub> - <sup>\*\*</sup>/<sub>4</sub>

1. Part No.
2. Material:  
(Blank): Nylon 66, UL94V-0  
GWT: Nylon 66, UL94V-0, GWT 750°C
3. Color:  
(Blank): Ivory  
BK: Black  
RD: Red  
YL: Yellow  
BL: Blue
4. Finish:  
(Blank): Tin over Nickel  
G: Gold over Nickel

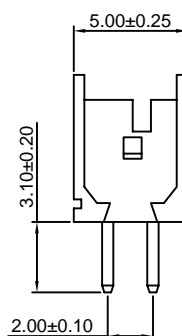
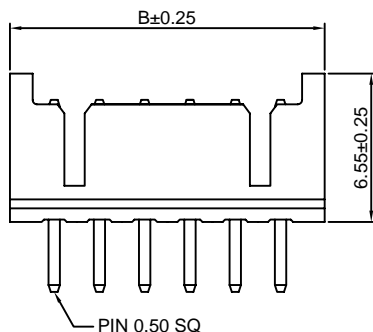
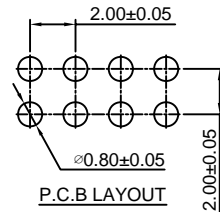
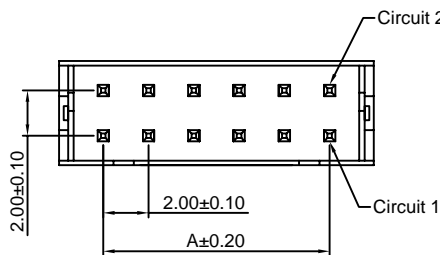

**Ordering Information & Dimensions:**

PART NO.	Dimensions	
	A	B
2x2P	2.00	8.00
2x3P	4.00	10.00
2x4P	6.00	12.00
2x5P	8.00	14.00
2x6P	10.00	16.00
2x7P	12.00	18.00
2x8P	14.00	20.00
2x9P	16.00	22.00
2x10P	18.00	24.00
2x11P	20.00	26.00
2x12P	22.00	28.00
2x13P	24.00	30.00
2x14P	26.00	32.00
2x15P	28.00	34.00
2x16P	30.00	36.00
2x17P	32.00	38.00
2x18P	34.00	40.00
2x19P	36.00	42.00
2x20P	38.00	44.00

Unit: mm

### A2006WRA-2xXP

2.00mm pitch 90° Dual Row Wafer

#### Reference Informations:

- \*Material: Pin: Brass/Tin over Nickel  
Insulator: Nylon 66, UL94V-0
- \*Mates with CJT A2006HA-2xXP series Dual Row Housing
- \*Color: Ivory

#### Ordering Information:

A2006WRA-2xXP - \*\*\* - \*\* - \*\*  
1 2 3 4

- Part No.
- Material:  
(Blank): Nylon 66, UL94V-0  
GWT: Nylon 66, UL94V-0, GWT 750°C
- Color:  
(Blank): Ivory  
BK: Black  
RD: Red  
YL: Yellow  
BL: Blue
- Finish:  
(Blank): Tin over Nickel  
G: Gold over Nickel

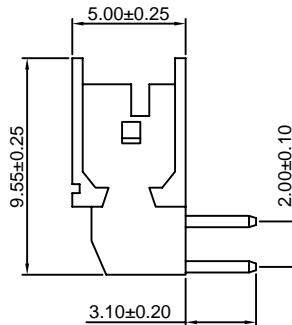
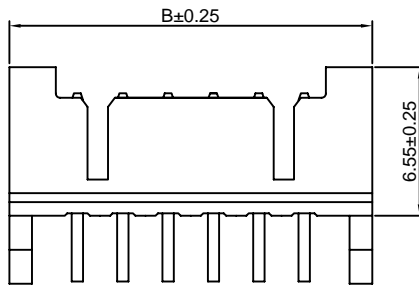
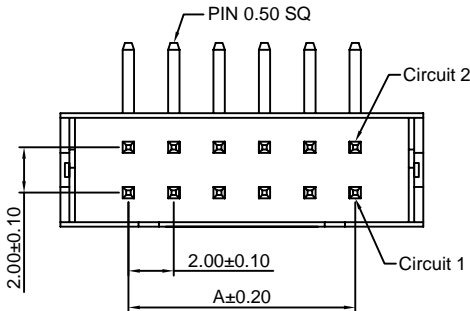
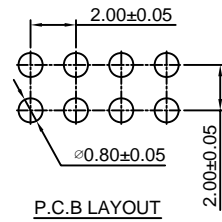

#### Ordering Information & Dimensions:

PART NO.	Dimensions	
	A	B
2x2P	2.00	8.00
2x3P	4.00	10.00
2x4P	6.00	12.00
2x5P	8.00	14.00
2x6P	10.00	16.00
2x7P	12.00	18.00
2x8P	14.00	20.00
2x9P	16.00	22.00
2x10P	18.00	24.00
2x11P	20.00	26.00
2x12P	22.00	28.00
2x13P	24.00	30.00
2x14P	26.00	32.00
2x15P	28.00	34.00
2x16P	30.00	36.00
2x17P	32.00	38.00
2x18P	34.00	40.00
2x19P	36.00	42.00
2x20P	38.00	44.00

Unit: mm

### A2006WV-S-2xXP

2.00mm pitch 180° Dual Row Wafer - SMT TYPE

#### Reference Informations:

- \*Material: Pin: Brass/Tin over Nickel  
Insulator: Nylon 6T, UL94V-0
- \*Mates with CJT A2006H-2xXP, A2009H-2xXP series Dual Row Housing
- \*Color: Ivory

#### Ordering Information:

A2006WV-S-2xXP - \*\*\* - \*\* - \*\*  
1 2 3 4

- Part No.
- Material:  
(Blank): Nylon 6T, UL94V-0  
GWT: Nylon 6T, UL94V-0, GWT 750°C
- Color:  
(Blank): Ivory  
BK: Black  
RD: Red  
YL: Yellow  
BL: Blue
- Finish:  
(Blank): Tin over Nickel  
G: Gold over Nickel

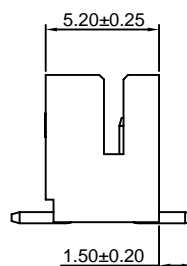
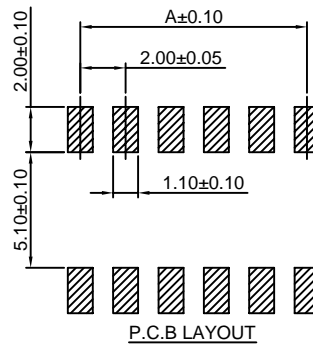
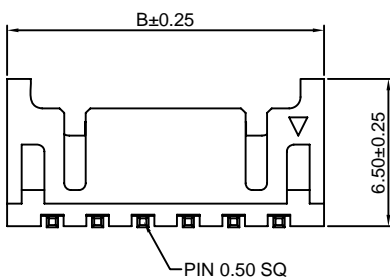
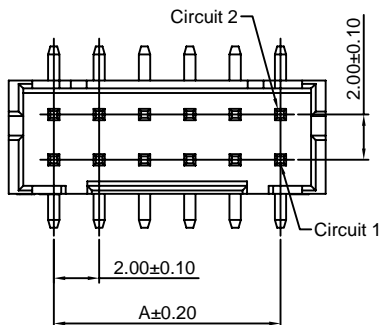
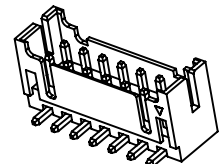

#### Ordering Information & Dimensions:

PART NO.	Dimensions	
	A	B
2x2P	2.00	6.00
2x3P	4.00	8.00
2x4P	6.00	10.00
2x5P	8.00	12.00
2x6P	10.00	14.00
2x7P	12.00	16.00
2x8P	14.00	18.00
2x9P	16.00	20.00
2x10P	18.00	22.00
2x11P	20.00	24.00
2x12P	22.00	26.00
2x13P	24.00	28.00
2x14P	26.00	30.00
2x15P	28.00	32.00
2x16P	30.00	34.00
2x17P	32.00	36.00
2x18P	34.00	38.00
2x19P	36.00	40.00
2x20P	38.00	42.00
2x21P	40.00	44.00
2x22P	42.00	46.00
2x23P	44.00	48.00
2x24P	46.00	50.00
2x25P	48.00	52.00

Unit: mm

### A2006WV-S-F-2xXP

2.00mm pitch 180° Dual Row Wafer - SMT TYPE

#### Reference Informations:

- \*Material: Pin: Brass/Tin over Nickel  
Insulator: Nylon 6T, UL94V-0
- \*Mates with CJT A2006H-2xXP, A2009H-2xXP series Dual Row Housing
- \*Color: Ivory

#### Ordering Information:

A2006WV-S-F-2xXP -  $\frac{***}{1} - \frac{**}{2} - \frac{**}{3} - \frac{**}{4}$

- Part No.
- Material:  
(Blank): Nylon 6T, UL94V-0  
GWT: Nylon 6T, UL94V-0, GWT 750 °C
- Color:  
(Blank): Ivory  
BK: Black  
RD: Red  
YL: Yellow  
BL: Blue
- Finish:  
(Blank): Tin over Nickel  
G: Gold over Nickel

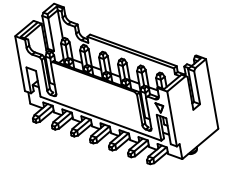

#### Ordering Information & Dimensions:

PART NO.	Dimensions		
	A	B	C
2x2P	2.00	6.00	4.00
2x3P	4.00	8.00	6.00
2x4P	6.00	10.00	8.00
2x5P	8.00	12.00	10.00
2x6P	10.00	14.00	12.00
2x7P	12.00	16.00	14.00
2x8P	14.00	18.00	16.00
2x9P	16.00	20.00	18.00
2x10P	18.00	22.00	20.00
2x11P	20.00	24.00	22.00
2x12P	22.00	26.00	24.00
2x13P	24.00	28.00	26.00
2x14P	26.00	30.00	28.00
2x15P	28.00	32.00	30.00
2x16P	30.00	34.00	32.00
2x17P	32.00	36.00	34.00
2x18P	34.00	38.00	36.00
2x19P	36.00	40.00	38.00
2x20P	38.00	42.00	40.00
2x21P	40.00	44.00	42.00
2x22P	42.00	46.00	44.00
2x23P	44.00	48.00	46.00
2x24P	46.00	50.00	48.00
2x25P	48.00	52.00	50.00

Unit: mm

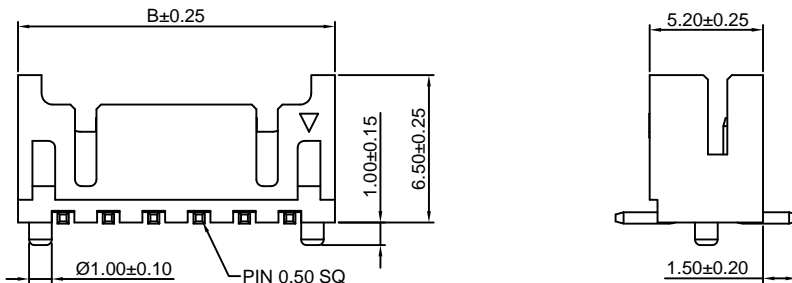
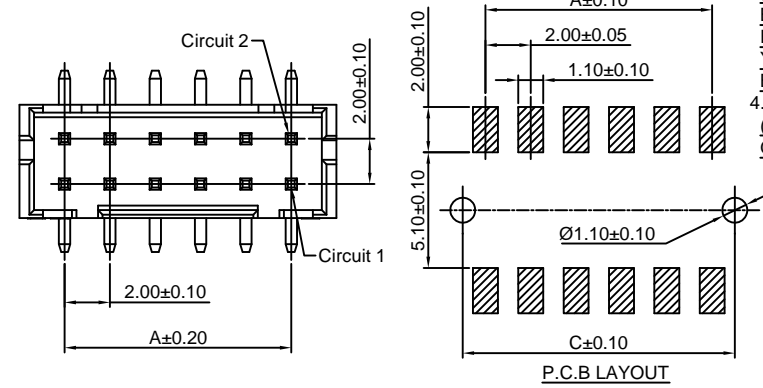

### A2006WVB-2xXP

2.00mm pitch 180° Dual Row Wafer

#### Reference Informations:

- \*Material: Pin: Brass/Tin over Nickel  
Insulator: Nylon 66, UL94V-0
- \*Mates with CJT A2006HB-2xXP series Dual Row Housing
- \*Color: White

#### Ordering Information:

A2006WVB-2xXP -  $\frac{***}{1} - \frac{**}{2} - \frac{**}{3} - \frac{**}{4}$

- Part No.
- Material:  
(Blank): Nylon 66, UL94V-0  
GWT: Nylon 66, UL94V-0, GWT 750 °C
- Color:  
(Blank): White  
BK: Black  
RD: Red  
YL: Yellow  
BL: Blue
- Finish:  
(Blank): Tin over Nickel  
G: Gold over Nickel

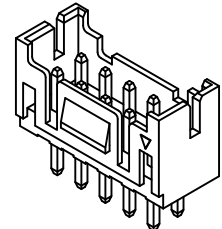

#### Ordering Information & Dimensions:

PART NO.	Dimensions	
	A	B
2x2P	2.00	6.00
2x3P	4.00	8.00
2x4P	6.00	10.00
2x5P	8.00	12.00
2x6P	10.00	14.00
2x7P	12.00	16.00
2x8P	14.00	18.00
2x9P	16.00	20.00
2x10P	18.00	22.00
2x11P	20.00	24.00
2x12P	22.00	26.00
2x13P	24.00	28.00
2x14P	26.00	30.00
2x15P	28.00	32.00
2x16P	30.00	34.00
2x17P	32.00	36.00
2x18P	34.00	38.00
2x19P	36.00	40.00
2x20P	38.00	42.00

Unit: mm

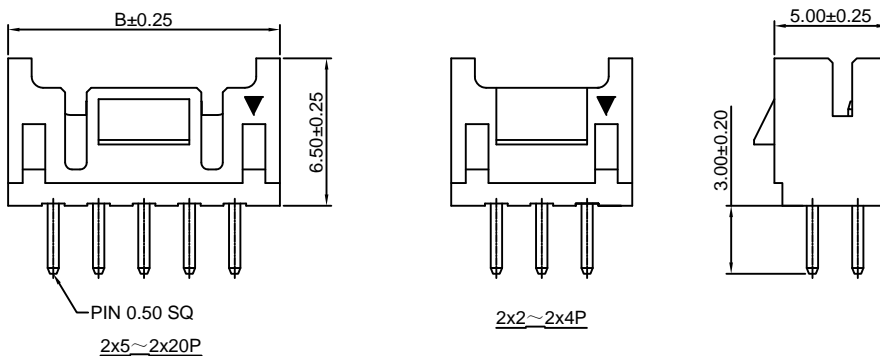
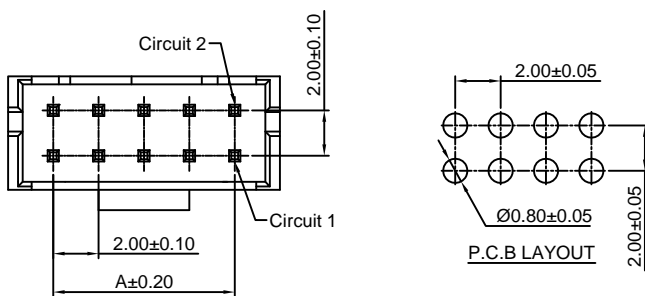



### A2006WRB-2xXP

2.00mm pitch 90° Dual Row Wafer

#### Reference Informations:

- \*Material:Pin:Brass/Tin over Nickel  
Insulator:Nylon 66,UL94V-0
- \*Mates with CJT A2006HB-2xXP series Dual Row Housing
- \*Color:White

#### Ordering Information:

A2006WRB-2xXP - \*\*\* - \*\* - \*\*  
1 2 3 4

- Part No.
- Material:  
(Blank):Nylon 66,UL94V-0  
GWT:Nylon 66,UL94V-0,GWT 750 °C
- Color:  
(Blank):White  
BK:Black  
RD:Red  
YL:Yellow  
BL:Blue
- Finish:  
(Blank):Tin over Nickel  
G:Gold over Nickel

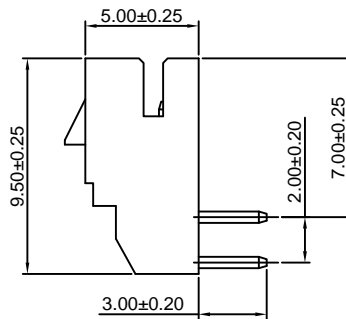
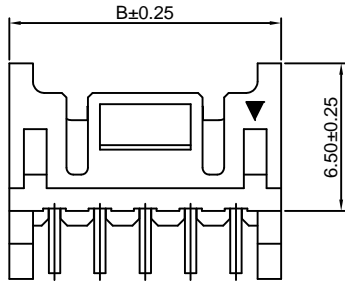
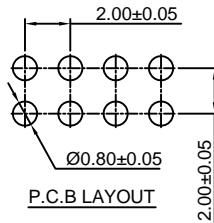
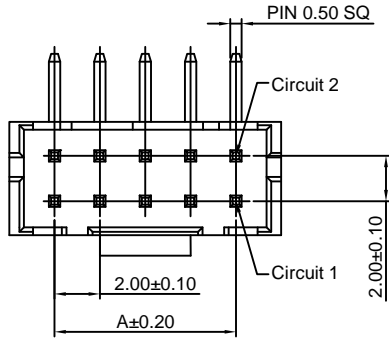
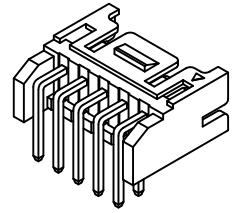

#### Ordering Information & Dimensions:

PART NO.	Dimensions	
	A	B
2x2P	2.00	6.00
2x3P	4.00	8.00
2x4P	6.00	10.00
2x5P	8.00	12.00
2x6P	10.00	14.00
2x7P	12.00	16.00
2x8P	14.00	18.00
2x9P	16.00	20.00
2x10P	18.00	22.00
2x11P	20.00	24.00
2x12P	22.00	26.00
2x13P	24.00	28.00
2x14P	26.00	30.00
2x15P	28.00	32.00
2x16P	30.00	34.00
2x17P	32.00	36.00
2x18P	34.00	38.00
2x19P	36.00	40.00
2x20P	38.00	42.00

Unit: mm

### A2006WVU-2xXP

2.00mm pitch 180° Dual Row Wafer

#### Reference Informations:

- \*Material:Pin:Brass/Tin over Nickel  
Insulator:PA4T,UL94V-0
- \*Mates with CJT A2006HU-2xXP series Dual Row Housing
- \*Color:Natural

#### Ordering Information:

A2006WVU-2xXP - \*\*\* - \*\* - \*\*  
1 2 3 4

- Part No.
- Material:  
(blank):PA4T,UL94V-0  
GWT:PA4T,UL94V-0,GWT 750 °C
- Color:  
(Blank):Natural  
BK:Black  
RD:Red  
YL:Yellow  
BL:Blue
- Finish:  
(Blank):Tin over Nickel  
G:Gold over Nickel

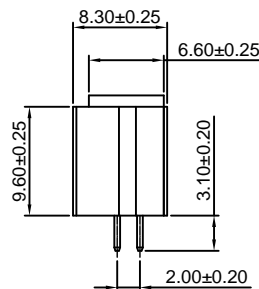
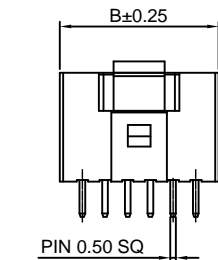
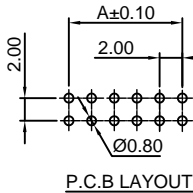
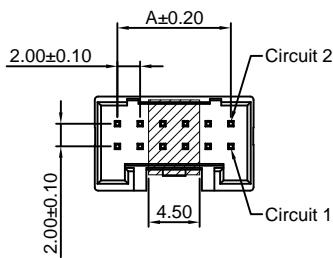
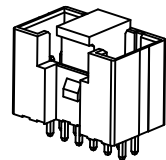

#### Ordering Information & Dimensions:

PART NO.	Dimensions	
	A	B
2x4P	6.00	10.00
2x5P	8.00	12.00
2x6P	10.00	14.00
2x7P	12.00	16.00
2x8P	14.00	18.00
2x9P	16.00	20.00
2x10P	18.00	22.00
2x11P	20.00	24.00
2x12P	22.00	26.00
2x13P	24.00	28.00
2x14P	26.00	30.00
2x15P	28.00	32.00
2x16P	30.00	34.00
2x17P	32.00	36.00
2x18P	34.00	38.00
2x19P	36.00	40.00
2x20P	38.00	42.00

Unit: mm

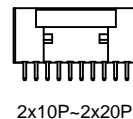
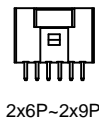
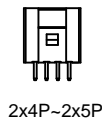
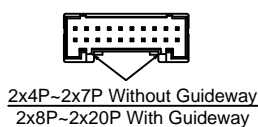

### A2006WVU-F-2xXP

2.00mm pitch 180° Dual Row Wafer

#### Reference Informations:

- \*Material:Pin:Brass/Tin over Nickel  
Insulator:PA4T,UL94V-0
- \*Mates with CJT A2006HU-2xXP series Dual Row Housing
- \*Color:Natural

#### Ordering Information:

A2006WVU-F-2xXP - <sup>\*\*\*</sup> - <sup>\*\*</sup> - <sup>\*\*</sup>  
1 2 3 4

- 1.Part No.
- 2.Material:  
(blank):PA4T,UL94V-0  
GWT:PA4T,UL94V-0,GWT 750 °C
- 3.Color:  
(Blank):Natural  
BK:Black  
RD:Red  
YL:Yellow  
BL:Blue
- 4.Finish:  
(Blank):Tin over Nickel  
G:Gold over Nickel

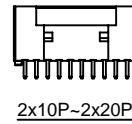
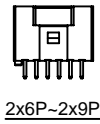
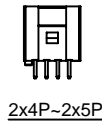
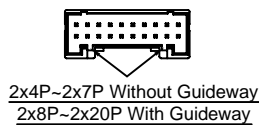
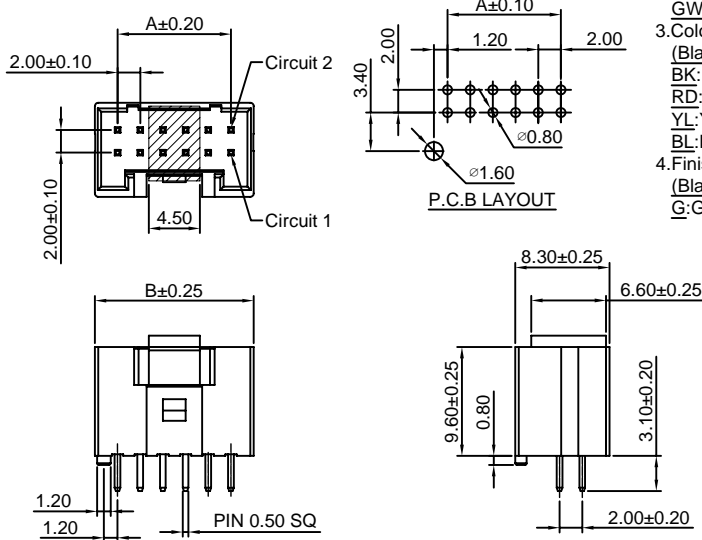
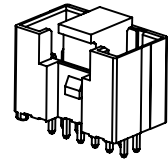

#### Ordering Information & Dimensions:

PART NO.	Dimensions	
	A	B
2x4P	6.00	10.00
2x5P	8.00	12.00
2x6P	10.00	14.00
2x7P	12.00	16.00
2x8P	14.00	18.00
2x9P	16.00	20.00
2x10P	18.00	22.00
2x11P	20.00	24.00
2x12P	22.00	26.00
2x13P	24.00	28.00
2x14P	26.00	30.00
2x15P	28.00	32.00
2x16P	30.00	34.00
2x17P	32.00	36.00
2x18P	34.00	38.00
2x19P	36.00	40.00
2x20P	38.00	42.00

Unit: mm

### A2006WRU-F-2xXP

2.00mm pitch 90° Dual Row Wafer

#### Reference Informations:

- \*Material:Pin:Brass/Tin over Nickel  
Insulator:PA4T,UL94V-0
- \*Mates with CJT A2006HU-2xXP series Dual Row Housing
- \*Color:Natural

#### Ordering Information:

A2006WRU-F-2xXP - <sup>\*\*\*</sup> - <sup>\*\*\*</sup> - <sup>\*\*</sup> - <sup>\*\*</sup>  
1 2 3 4 5

- 1.Part No.
- 2.Size(L):  
(blank):3.00mm  
L18:1.80mm
- 3.Material:  
(blank):PA4T,UL94V-0  
GWT:PA4T,UL94V-0,GWT 750 °C
- 4.Color:  
(Blank):Natural  
BK:Black  
RD:Red  
YL:Yellow  
BL:Blue
- 5.Finish:  
(Blank):Tin over Nickel  
G:Gold over Nickel

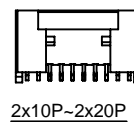
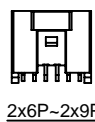
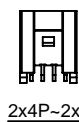
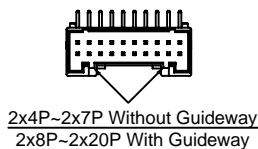
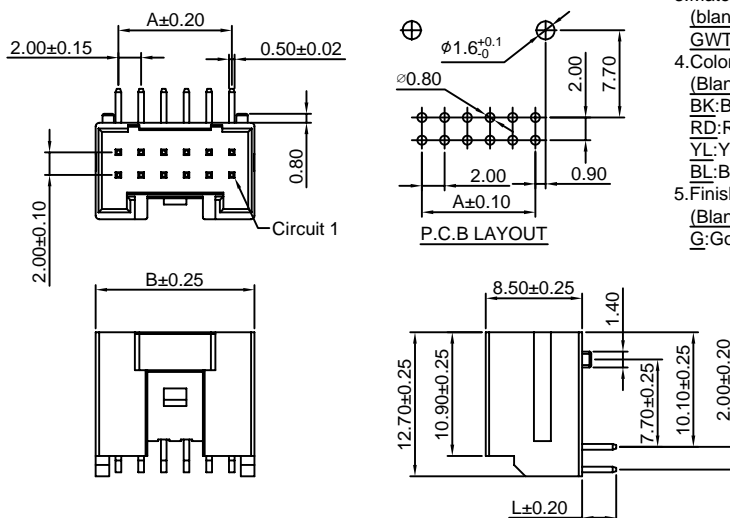
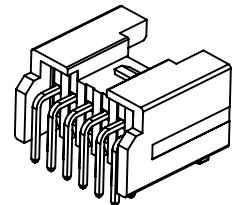

#### Ordering Information & Dimensions:

PART NO.	Dimensions	
	A	B
2x4P	6.00	10.00
2x5P	8.00	12.00
2x6P	10.00	14.00
2x7P	12.00	16.00
2x8P	14.00	18.00
2x9P	16.00	20.00
2x10P	18.00	22.00
2x11P	20.00	24.00
2x12P	22.00	26.00
2x13P	24.00	28.00
2x14P	26.00	30.00
2x15P	28.00	32.00
2x16P	30.00	34.00
2x17P	32.00	36.00
2x18P	34.00	38.00
2x19P	36.00	40.00
2x20P	38.00	42.00

Unit: mm

## A2009H-2xXP

2.00mm pitch Dual Row Housing

### Reference Informations:

- \*Material:Nylon 66,UL94V-0
- \*Suitable CJT A2008-T series Terminal
- \*Mates with CJT A2006WV,WR,WV-S,WV-S-F-2xXP series Dual Row Wafer
- \*Color:Black

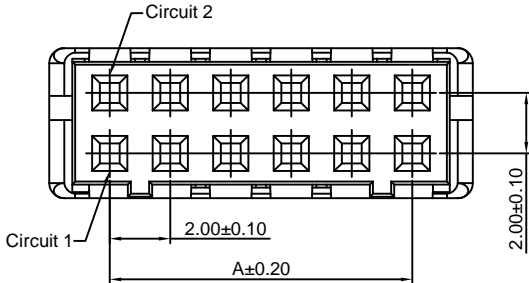
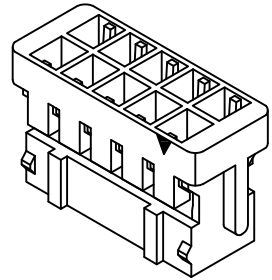

Ordering Information:  
A2009H-2xXP - \*\*\* - \*\*\*  
1 2 3

- 1.Part No.
- 2.Material:  
(Blank):Nylon 66,UL94V-0  
GWT:Nylon 66,UL94V-0,GWT 750°C
- 3.Color:  
(Blank):Black  
GY:Gray  
WH:White

### Ordering Information & Dimensions:

PART NO.	Dimensions	
	A	B
2x2P	2.00	6.00
2x3P	4.00	8.00
2x4P	6.00	10.00
2x5P	8.00	12.00
2x6P	10.00	14.00
2x7P	12.00	16.00
2x8P	14.00	18.00
2x9P	16.00	20.00
2x10P	18.00	22.00
2x11P	20.00	24.00
2x12P	22.00	26.00
2x13P	24.00	28.00
2x14P	26.00	30.00
2x15P	28.00	32.00
2x16P	30.00	34.00
2x17P	32.00	36.00
2x18P	34.00	38.00
2x19P	36.00	40.00
2x20P	38.00	42.00

Unit: mm

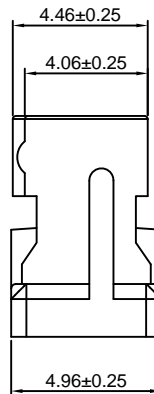
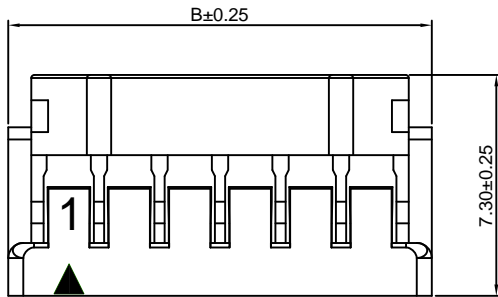

## A2009WV-S-2xXP

2.00mm pitch 180° Dual Row Wafer-SMT TYPE

### Reference Informations:

- \*Material:Pin:Brass/Tin over Nickel  
Insulator:Nylon 9T,UL94V-0  
Cap:Nylon 46,UL94V-0(Black)
- \*Mates with CJT A2009H-2xXP series Dual Row Wafer
- \*Color:Beige

Ordering Information:  
A2009WV-S-2xXP - \*\*\* - \*\*  
1 2 3

- 1.Part No.
- 2.Material:  
(Blank):Nylon 9T,UL94V-0  
GWT:Nylon 9T,UL94V-0,GWT 750°C
- 3.Finish:  
(Blank):Tin over Nickel  
G:Gold over Nickel

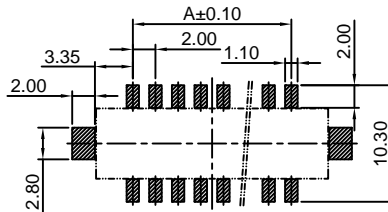

P.C.B LAYOUT

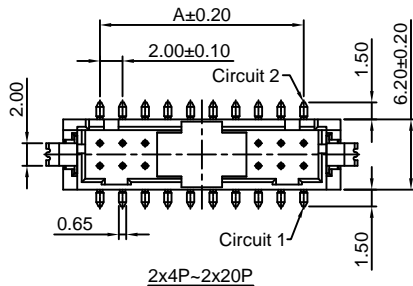

2x4P~2x20P

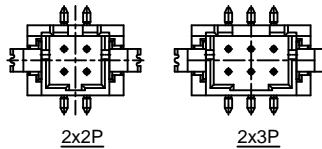

2x2P

2x3P

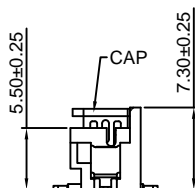
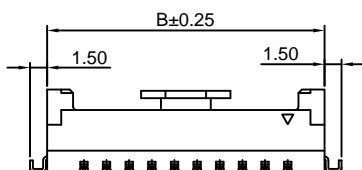

### Ordering Information & Dimensions:

PART NO.	Dimensions	
	A	B
2x2P	2.00	8.50
2x3P	4.00	10.50
2x4P	6.00	12.50
2x5P	8.00	14.50
2x6P	10.00	16.50
2x7P	12.00	18.50
2x8P	14.00	20.50
2x9P	16.00	22.50
2x10P	18.00	24.50
2x11P	20.00	26.50
2x12P	22.00	28.50
2x13P	24.00	30.50
2x14P	26.00	32.50
2x15P	28.00	34.50
2x16P	30.00	36.50
2x17P	32.00	38.50
2x18P	34.00	40.50
2x19P	36.00	42.50
2x20P	38.00	44.50

Unit: mm