



PLCC LED Series Datasheet

ORH-W45A(IF=15mA)



1. Features:

- Chip material: AlInGaN.
- Emitted Color : Super Blue.
- Lens Appearance: Water Clear.
- Mono-color type.
- 2.0x1.25x0.8mm (0805) standard package.
- Suitable for all SMT assembly methods.
- Compatible with infrared and vapor phase reflow solder process.
- Compatible with automatic placement equipment.
- This product doesn't contain restriction substance, comply ROHS standard.

2.Applications:

- Automotive: Dashboards, stop lamps, turn signals.
- Backlighting: LCDs, Key pads advertising.
- Status indicators: Consumer & industrial electronics.
- General use.

3.Package Dimensions:

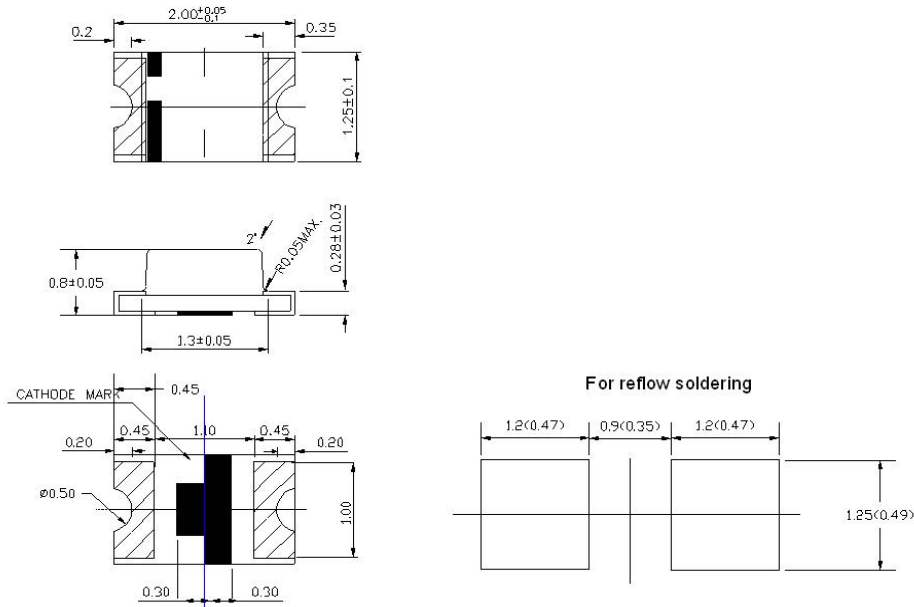

NOTES:

1. All dimensions are in millimeters (inches).
2. Tolerance is ± 0.10 mm (0.004") unless otherwise specified.
3. Specifications are subject to change without notice.

4. Absolute Maximum Ratings (Ta=25°C)

Parameter	Symbol	Rating	Unit
Power Dissipation	Pd	120	mW
Forward Current	I _F	30	mA
Peak Forward Current * 1	I _{FP}	100	mA
Operating Temperature	Topr	-25°C~80°C	-
Storage Temperature	Tstg	-30°C~85°C	-
Soldering Temperature	Tsol	260°C	-

* 1 Condition for I_{FP} is pulse of 1/10 duty and 0.1msec width.

5. Electrical and optical characteristics (Ta=25°C)

Parameter	Symbol	Condition	Min.	Typ.	Max.	Unit
Forward Voltage	V _f	I _F =15mA	2.8	2.9	3.1	V
Luminous Intensity	I _v	I _F =15mA	600	800	900	mcd
Reverse Current	I _R	V _R =7V	-	-	1	μA
Chromaticity	x	I _F =15mA	-	0.33	-	-
Coordinates	y	I _F =15mA	-	0.36	-	-
Viewing Angle	2θ _{1/2}	I _F =15mA	-	120	-	deg

6. Typical Electro-Optical Characteristics Curves

Fig.1 Relative intensity vs. wavelength

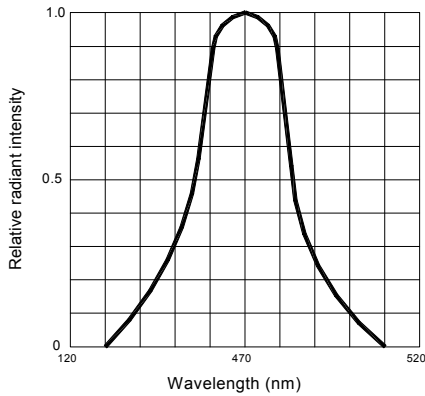

Fig.2 Forward current derating curve vs. ambient temperature

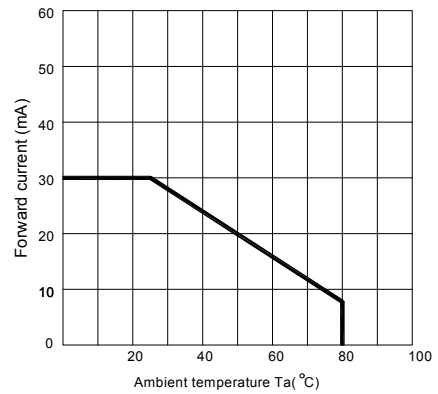

Fig.3 Forward current vs. forward voltage

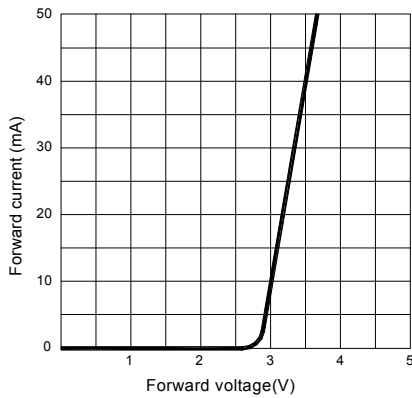

Fig.4 Relative luminous intensity vs. ambient temperature

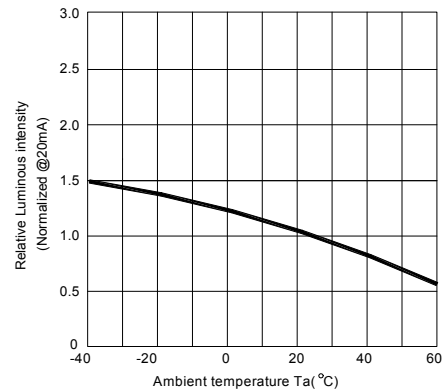

Fig.5 Relative luminous intensity vs. forward current

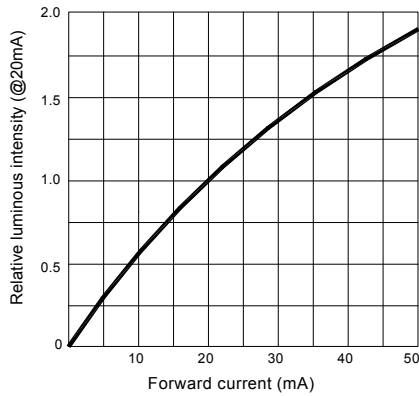
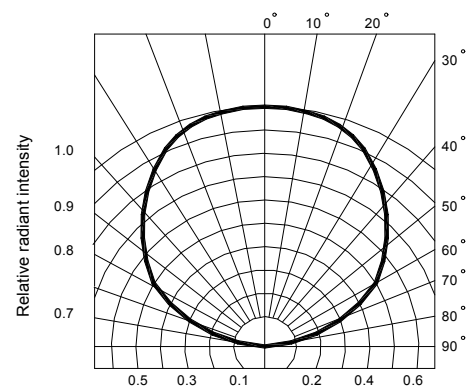

Fig.6 Radiation diagram





7. Judgment criteria of failure for the reliability

Measuring items	Symbol	Measuring conditions	Judgement criteria for failure
Forward voltage	V_F (V)	$I_F=5mA$	Over $U \times 1.2$
Reverse current	$I_R(uA)$	$V_R=5V$	Over $U \times 2$
Luminous intensity	I_v (mcd)	$I_F=5mA$	Below $S \times 0.5$

Note: 1).U means the upper limit of specified characteristics. S means initial value.
 2).Measurement shall be taken between 2 hours and after the test pieces have been returned to normal ambient conditions after completion of each test.

8. Bin Limits

Intensity Bin Limits (At 15mA)

BIN CODE	Min. (mcd)	Max. (mcd)
Q	600	700
W	700	800
E	800	900

Tolerance for each Bin limit is $\pm 15\%$.

Color Bin Limits (At 15mA)

BIN	X1	Y1	X2	Y2	X3	Y3	X4	Y4
1	0.291	0.31	0.2963	0.32	0.3108	0.32	0.3058	0.31
2	0.2963	0.32	0.3015	0.33	0.316	0.33	0.3108	0.32
3	0.3015	0.33	0.3067	0.34	0.3214	0.34	0.316	0.33
4	0.3067	0.34	0.3122	0.35	0.3265	0.35	0.3214	0.34
5	0.3122	0.35	0.3173	0.36	0.3315	0.36	0.3265	0.35
6	0.3173	0.36	0.3225	0.37	0.337	0.37	0.3315	0.36

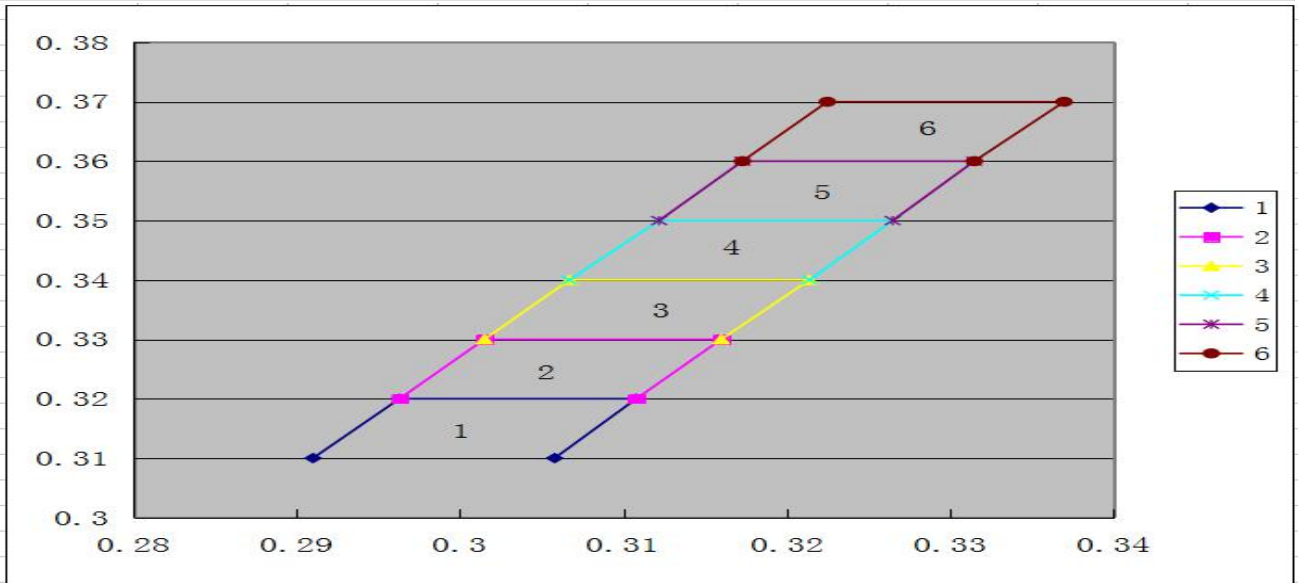

V_F Bin Limits (At 15mA)

BIN CODE	Min.(v)	Max.(v)
S	2.8	2.9
D	2.9	3
F	3	3.1

Tolerance for each Bin limit is $\pm 0.05V$.

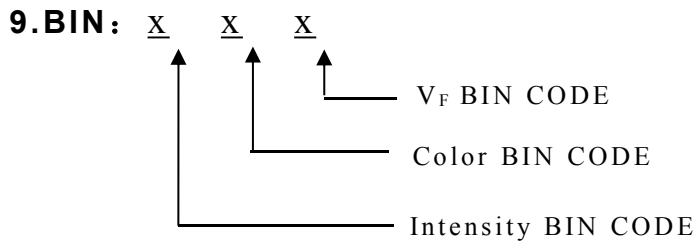

10. Tapping and packaging specifications (Units: mm)

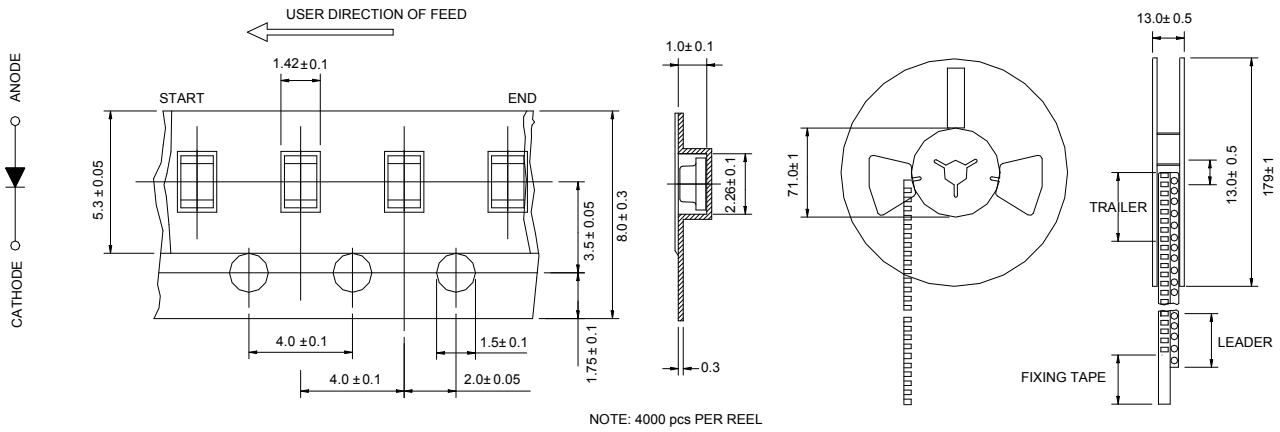

11. Package Method: (unit: mm)

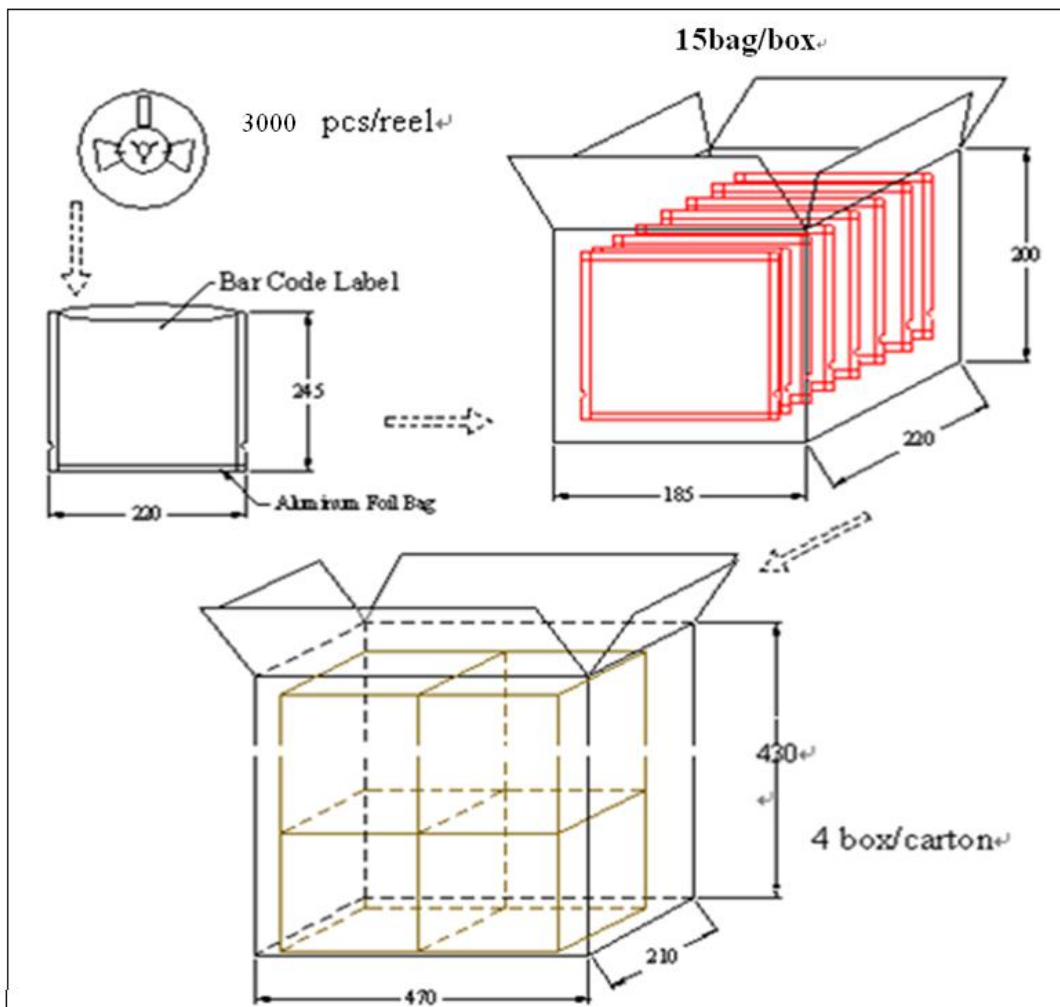



12. Package and Label of Products:

- (1) Package: Products are packed in one bag of 3000 pcs (one taping reel) and a label is attached on each bag.
- (2) Label:

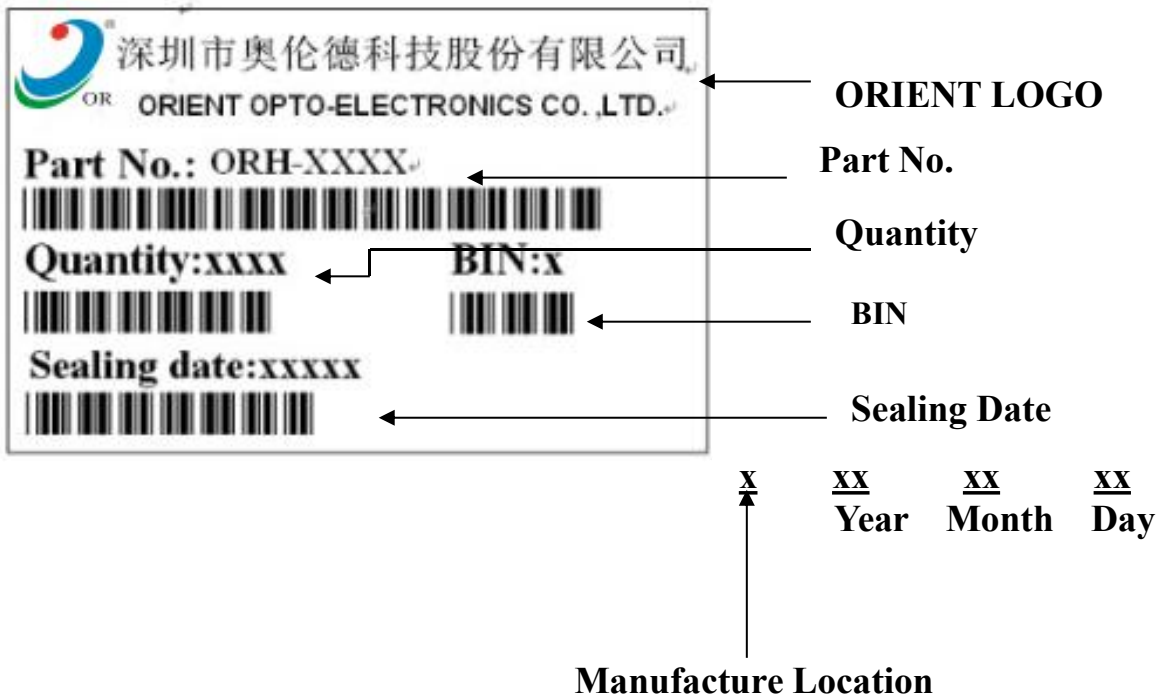



13. Reliability Test

Classification	Test Item	Reference Standard	Test Conditions	Result
Endurance Test	Operation Life	MIL-STD-750:1026 MIL-STD-883:1005 JIS-C-7021 :B-1	Connect with a power If=20mA Ta=Under room temperature Test time=1,000hrs	0/20
	High Temperature High Humidity Storage	MIL-STD-202:103B JIS-C-7021 :B-11	Ta=+65°C±5°C RH=90%-95% Test time=240hrs	0/20
	High Temperature Storage	MIL-STD-883:1008 JIS-C-7021 :B-10	High Ta=+85°C±5°C Test time=1,000hrs	0/20
	Low Temperature Storage	JIS-C-7021 :B-12	Low Ta=-35°C±5°C Test time=1,000hrs	0/20
Environmental Test	Temperature Cycling	MIL-STD-202:107D MIL-STD-750:1051 MIL-STD-883:1010 JIS-C-7021 :A-4	-35°C ~ +25°C ~ +85°C ~ +25°C 60min 20min 60min 20min Test Time=5cycle	0/20
	Thermal Shock	MIL-STD-202:107D MIL-STD-750:1051 MIL-STD-883:1011	-35°C±5°C ~+85°C±5°C 20min 20min Test Time=10cycle	0/20
	Solder Resistance	MIL-STD-202:201A MIL-STD-750:2031 JIS-C-7021 :A-1	Preheating: 140°C-160°C, within 2 minutes. Operation heating: 260°C (Max.), within 10seconds. (Max.)	0/20

14. Soldering :

1). Manual Of Soldering

The temperature of the iron tip should not be higher than 300°C (572°F) and Soldering within 3 seconds per solder-land is to be observed.

2). Reflow Soldering

Preheating : 140°C~160°C±5°C, within 2 minutes.

Operation heating : 260°C (Max.) within 10 seconds.(Max)

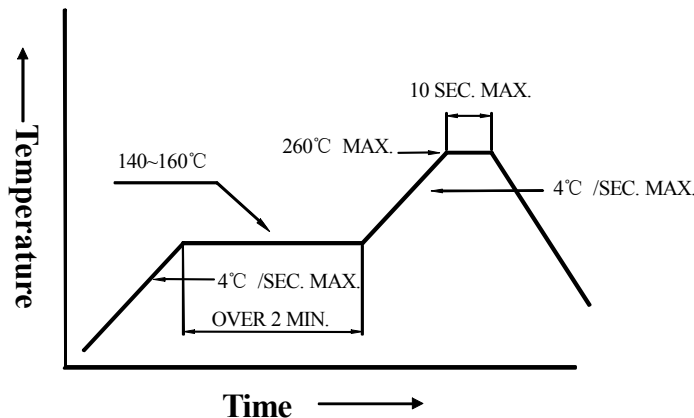

Gradual Cooling (Avoid quenching).

- 3). DIP soldering (Wave Soldering) :
- Preheating : 120°C~150°C, within 120~180 sec.
 - Operation heating : 245°C ±5°C within 5 sec. 260°C (Max)
 - Gradual Cooling (Avoid quenching).

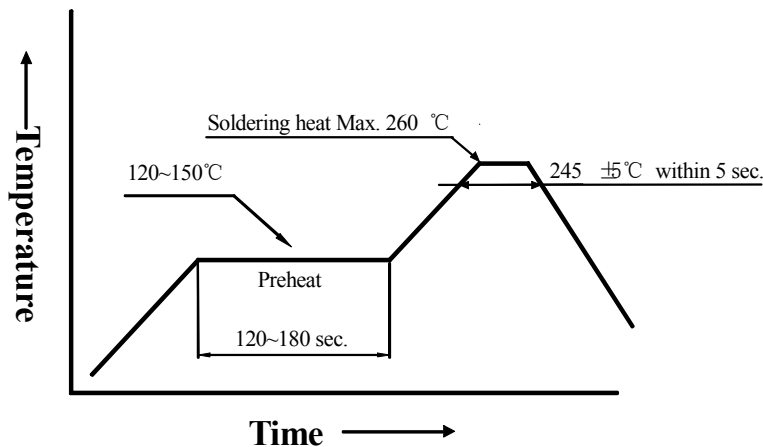

15.Handling :

Care must be taken not to cause to the epoxy resin portion of ORIENTLEDs while it is exposed to high temperature.
 Care must be taken not rub the epoxy resin portion of ORIENT LEDs with hard or sharp article such as the sand blast and the metal hook.

16.Notes for designing:

Care must be taken to provide the current limiting resistor in the circuit so as to drive the ORIENT LEDs within the rated figures. Also, caution should be taken not to overload ORIENT LEDs with instantaneous voltage at the turning ON and OFF of the circuit.
 When using the pulse drive care must be taken to keep the average current within the rated figures. Also, the circuit should be designed so as be subjected to reverse voltage when turning off the ORIENT LEDs.



17. Storage:

In order to avoid the absorption of moisture, it is recommended to solder ORIENT LEDs as soon as possible after unpacking the sealed envelope.

If the envelope is still packed, to store it in the environment as following:

- (1) Temperature : 5°C-30°C (41°F) Humidity : RH 60% Max.
- (2) After this bag is opened, devices that will be applied to infrared reflow, vapor-phase reflow, or equivalent soldering process must be:
 - a.... Completed within 24 hours.
 - b.... Stored at less than 30% RH.
- (3) Devices require baking before mounting, if:
 - (2) a or (2) b is not met.
- (4) If baking is required, devices must be baked under below conditions:
 - 12 hours at 60°C±3°C.