

# DATA SHEET

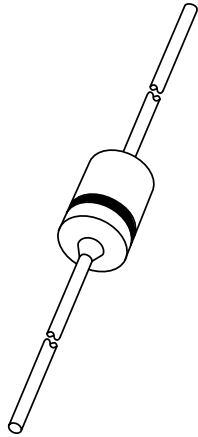

## **BZX79 series** Voltage regulator diodes

Product specification  
Supersedes data of 1999 May 25

2002 Feb 27

## Voltage regulator diodes

## BZX79 series

## FEATURES

- Total power dissipation: max. 500 mW
- Two tolerance series:  $\pm 2\%$ , and approx.  $\pm 5\%$
- Working voltage range: nom. 2.4 to 75 V (E24 range)
- Non-repetitive peak reverse power dissipation: max. 40 W.

## APPLICATIONS

- Low voltage stabilizers or voltage references.

## DESCRIPTION

Low-power voltage regulator diodes in hermetically sealed leaded glass SOD27 (DO-35) packages. The diodes are available in the normalized E24  $\pm 2\%$  (BZX79-B) and approx.  $\pm 5\%$  (BZX79-C) tolerance range. The series consists of 37 types with nominal working voltages from 2.4 to 75 V.

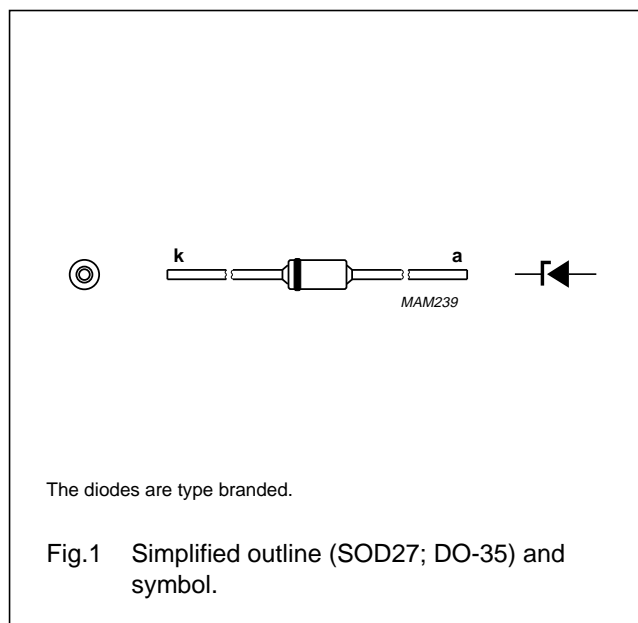

## LIMITING VALUES

In accordance with the Absolute Maximum Rating System (IEC 60134).

SYMBOL	PARAMETER	CONDITIONS	MIN.	MAX.	UNIT
$I_F$	continuous forward current		–	250	mA
$I_{ZSM}$	non-repetitive peak reverse current	$t_p = 100 \mu\text{s}$ ; square wave; $T_j = 25 \text{ }^\circ\text{C}$ prior to surge	see Tables 1 and 2		A
$P_{tot}$	total power dissipation	$T_{amb} = 50 \text{ }^\circ\text{C}$ ; note 1	–	400	mW
		$T_{amb} = 50 \text{ }^\circ\text{C}$ ; note 2	–	500	mW
$P_{ZSM}$	non-repetitive peak reverse power dissipation	$t_p = 100 \mu\text{s}$ ; square wave; $T_j = 25 \text{ }^\circ\text{C}$ prior to surge; see Fig.3	–	40	W
$T_{stg}$	storage temperature		–65	+200	$^\circ\text{C}$
$T_j$	junction temperature		–65	+200	$^\circ\text{C}$

## Notes

1. Device mounted on a printed circuit-board without metallization pad; lead length max.
2. Tie-point temperature  $\leq 50 \text{ }^\circ\text{C}$ ; max. lead length 8 mm.

## ELECTRICAL CHARACTERISTICS

## Total BZX79-B and BZX79-C series

$T_j = 25 \text{ }^\circ\text{C}$  unless otherwise specified.

SYMBOL	PARAMETER	CONDITIONS	MAX.	UNIT
$V_F$	forward voltage	$I_F = 10 \text{ mA}$ ; see Fig.4	0.9	V

## Voltage regulator diodes

## BZX79 series

SYMBOL	PARAMETER	CONDITIONS	MAX.	UNIT
$I_R$	reverse current			
	BZX79-B/C2V4	$V_R = 1\text{ V}$	50	$\mu\text{A}$
	BZX79-B/C2V7	$V_R = 1\text{ V}$	20	$\mu\text{A}$
	BZX79-B/C3V0	$V_R = 1\text{ V}$	10	$\mu\text{A}$
	BZX79-B/C3V3	$V_R = 1\text{ V}$	5	$\mu\text{A}$
	BZX79-B/C3V6	$V_R = 1\text{ V}$	5	$\mu\text{A}$
	BZX79-B/C3V9	$V_R = 1\text{ V}$	3	$\mu\text{A}$
	BZX79-B/C4V3	$V_R = 1\text{ V}$	3	$\mu\text{A}$
	BZX79-B/C4V7	$V_R = 2\text{ V}$	3	$\mu\text{A}$
	BZX79-B/C5V1	$V_R = 2\text{ V}$	2	$\mu\text{A}$
	BZX79-B/C5V6	$V_R = 2\text{ V}$	1	$\mu\text{A}$
	BZX79-B/C6V2	$V_R = 4\text{ V}$	3	$\mu\text{A}$
	BZX79-B/C6V8	$V_R = 4\text{ V}$	2	$\mu\text{A}$
	BZX79-B/C7V5	$V_R = 5\text{ V}$	1	$\mu\text{A}$
	BZX79-B/C8V2	$V_R = 5\text{ V}$	700	$\text{nA}$
	BZX79-B/C9V1	$V_R = 6\text{ V}$	500	$\text{nA}$
	BZX79-B/C10	$V_R = 7\text{ V}$	200	$\text{nA}$
	BZX79-B/C11	$V_R = 8\text{ V}$	100	$\text{nA}$
	BZX79-B/C12	$V_R = 8\text{ V}$	100	$\text{nA}$
BZX79-B/C13	$V_R = 8\text{ V}$	100	$\text{nA}$	
BZX79-B/C15 to BZX79-B/C75	$V_R = 0.7V_{Znom}$	50	$\text{nA}$	

## Voltage regulator diodes

## BZX79 series

**Table 1** Per type, BZX79-B/C2V4 to BZX79-B/C24 $T_j = 25\text{ °C}$  unless otherwise specified.

BZX79- Bxxx Cxxx	WORKING VOLTAGE $V_Z$ (V) at $I_{Ztest} = 5\text{ mA}$				DIFFERENTIAL RESISTANCE $r_{dif}$ ( $\Omega$ )				TEMP. COEFF. $S_Z$ (mV/K) at $I_{Ztest} = 5\text{ mA}$ (see Figs 5 and 6)			DIODE CAP. $C_d$ (pF) at $f = 1\text{ MHz}$ ; $V_R = 0\text{ V}$	NON-REPETITIVE PEAK REVERSE CURRENT $I_{ZSM}$ (A) at $t_p = 100\text{ }\mu\text{s}$ ; $T_{amb} = 25\text{ °C}$
	Tol. $\pm 2\%$ (B)		Tol. approx. $\pm 5\%$ (C)		at $I_{Ztest} = 1\text{ mA}$		at $I_{Ztest} = 5\text{ mA}$						
	MIN.	MAX.	MIN.	MAX.	TYP.	MAX.	TYP.	MAX.	MIN.	TYP.	MAX.	MAX.	MAX.
2V4	2.35	2.45	2.2	2.6	275	600	70	100	-3.5	-1.6	0	450	6.0
2V7	2.65	2.75	2.5	2.9	300	600	75	100	-3.5	-2.0	0	450	6.0
3V0	2.94	3.06	2.8	3.2	325	600	80	95	-3.5	-2.1	0	450	6.0
3V3	3.23	3.37	3.1	3.5	350	600	85	95	-3.5	-2.4	0	450	6.0
3V6	3.53	3.67	3.4	3.8	375	600	85	90	-3.5	-2.4	0	450	6.0
3V9	3.82	3.98	3.7	4.1	400	600	85	90	-3.5	-2.5	0	450	6.0
4V3	4.21	4.39	4.0	4.6	410	600	80	90	-3.5	-2.5	0	450	6.0
4V7	4.61	4.79	4.4	5.0	425	500	50	80	-3.5	-1.4	0.2	300	6.0
5V1	5.00	5.20	4.8	5.4	400	480	40	60	-2.7	-0.8	1.2	300	6.0
5V6	5.49	5.71	5.2	6.0	80	400	15	40	-2.0	1.2	2.5	300	6.0
6V2	6.08	6.32	5.8	6.6	40	150	6	10	0.4	2.3	3.7	200	6.0
6V8	6.66	6.94	6.4	7.2	30	80	6	15	1.2	3.0	4.5	200	6.0
7V5	7.35	7.65	7.0	7.9	30	80	6	15	2.5	4.0	5.3	150	4.0
8V2	8.04	8.36	7.7	8.7	40	80	6	15	3.2	4.6	6.2	150	4.0
9V1	8.92	9.28	8.5	9.6	40	100	6	15	3.8	5.5	7.0	150	3.0
10	9.80	10.20	9.4	10.6	50	150	8	20	4.5	6.4	8.0	90	3.0
11	10.80	11.20	10.4	11.6	50	150	10	20	5.4	7.4	9.0	85	2.5
12	11.80	12.20	11.4	12.7	50	150	10	25	6.0	8.4	10.0	85	2.5
13	12.70	13.30	12.4	14.1	50	170	10	30	7.0	9.4	11.0	80	2.5
15	14.70	15.30	13.8	15.6	50	200	10	30	9.2	11.4	13.0	75	2.0
16	15.70	16.30	15.3	17.1	50	200	10	40	10.4	12.4	14.0	75	1.5
18	17.60	18.40	16.8	19.1	50	225	10	45	12.4	14.4	16.0	70	1.5
20	19.60	20.40	18.8	21.2	60	225	15	55	12.3	15.6	18.0	60	1.5
22	21.60	22.40	20.8	23.3	60	250	20	55	14.1	17.6	20.0	60	1.25
24	23.50	24.50	22.8	25.6	60	250	25	70	15.9	19.6	22.0	55	1.25

## Voltage regulator diodes

## BZX79 series

**Table 2** Per type, BZX79-B/C27 to BZX79-B/C75 $T_j = 25\text{ °C}$  unless otherwise specified.

BZX79- Bxxx Cxxx	WORKING VOLTAGE $V_Z$ (V) at $I_{Ztest} = 2\text{ mA}$				DIFFERENTIAL RESISTANCE $r_{dif}$ ( $\Omega$ )				TEMP. COEFF. $S_Z$ (mV/K) at $I_{Ztest} = 2\text{ mA}$ (see Figs 5 and 6)			DIODE CAP. $C_d$ (pF) at $f = 1\text{ MHz}$ ; $V_R = 0\text{ V}$	NON-REPETITIVE PEAK REVERSE CURRENT $I_{ZSM}$ (A) at $t_p = 100\text{ }\mu\text{s}$ ; $T_{amb} = 25\text{ °C}$
	Tol. $\pm 2\%$ (B)		Tol. approx. $\pm 5\%$ (C)		at $I_{Ztest} = 0.5\text{ mA}$		at $I_{Ztest} = 2\text{ mA}$		MIN.	TYP.	MAX.	MAX.	MAX.
	MIN.	MAX.	MIN.	MAX.	TYP.	MAX.	TYP.	MAX.					
27	26.50	27.50	25.1	28.9	65	300	25	80	18.0	22.7	25.3	50	1.0
30	29.40	30.60	28.0	32.0	70	300	30	80	20.6	25.7	29.4	50	1.0
33	32.30	33.70	31.0	35.0	75	325	35	80	23.3	28.7	33.4	45	0.9
36	35.30	36.70	34.0	38.0	80	350	35	90	26.0	31.8	37.4	45	0.8
39	38.20	39.80	37.0	41.0	80	350	40	130	28.7	34.8	41.2	45	0.7
43	42.10	43.90	40.0	46.0	85	375	45	150	31.4	38.8	46.6	40	0.6
47	46.10	47.90	44.0	50.0	85	375	50	170	35.0	42.9	51.8	40	0.5
51	50.00	52.00	48.0	54.0	90	400	60	180	38.6	46.9	57.2	40	0.4
56	54.90	57.10	52.0	60.0	100	425	70	200	42.2	52.0	63.8	40	0.3
62	60.80	63.20	58.0	66.0	120	450	80	215	58.8	64.4	71.6	35	0.3
68	66.60	69.40	64.0	72.0	150	475	90	240	65.6	71.7	79.8	35	0.25
75	73.50	76.50	70.0	79.0	170	500	95	255	73.4	80.2	88.6	35	0.2

Voltage regulator diodes

BZX79 series

**THERMAL CHARACTERISTICS**

SYMBOL	PARAMETER	CONDITIONS	VALUE	UNIT
$R_{th\ j-tp}$	thermal resistance from junction to tie-point	lead length 8 mm.	300	K/W
$R_{th\ j-a}$	thermal resistance from junction to ambient	lead length max.; see Fig.2 and note 1	380	K/W

**Note**

1. Device mounted on a printed circuit-board without metallization pad.

**GRAPHICAL DATA**

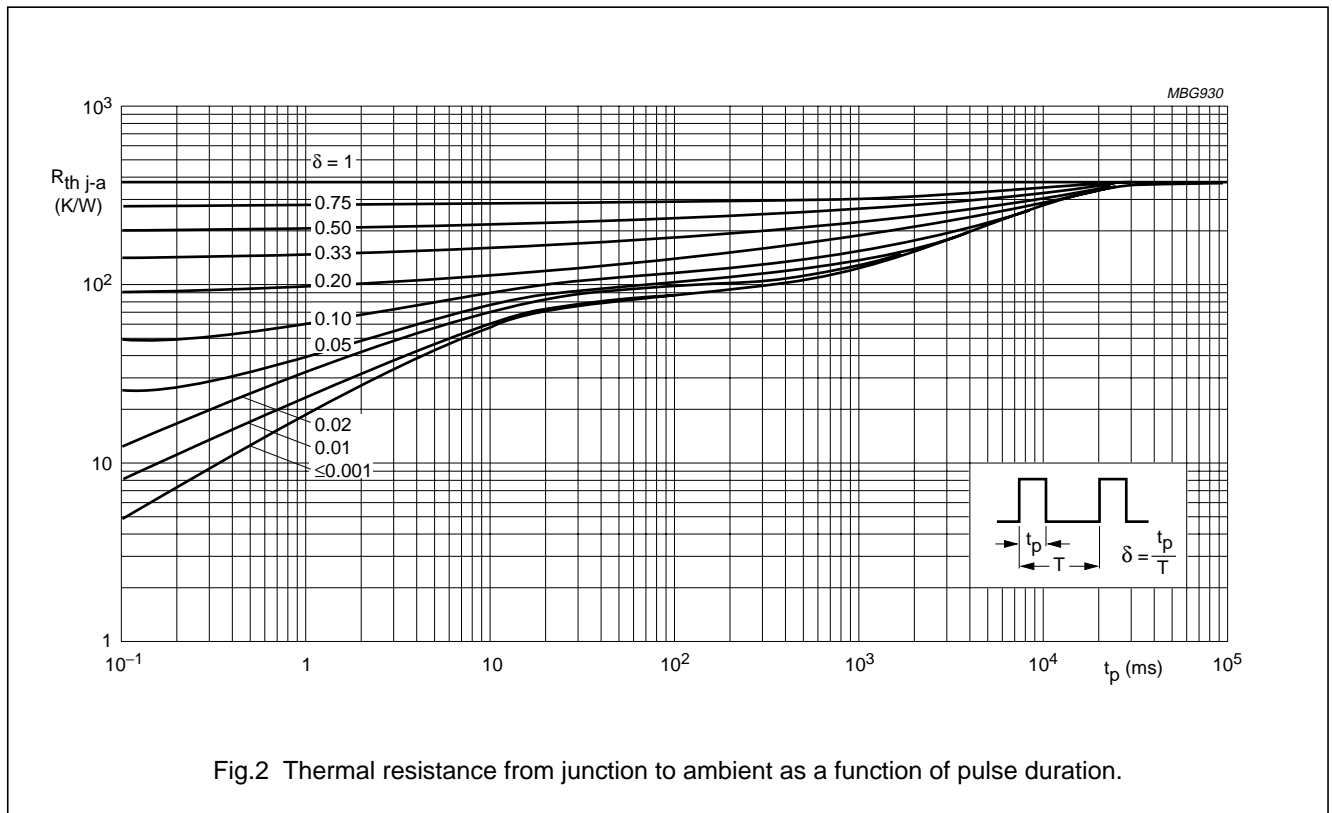

Voltage regulator diodes

BZX79 series

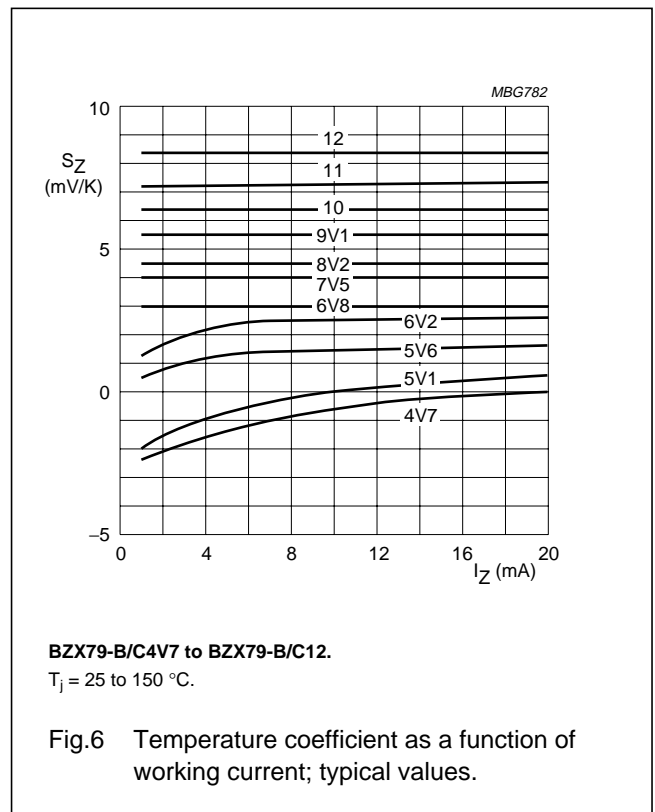
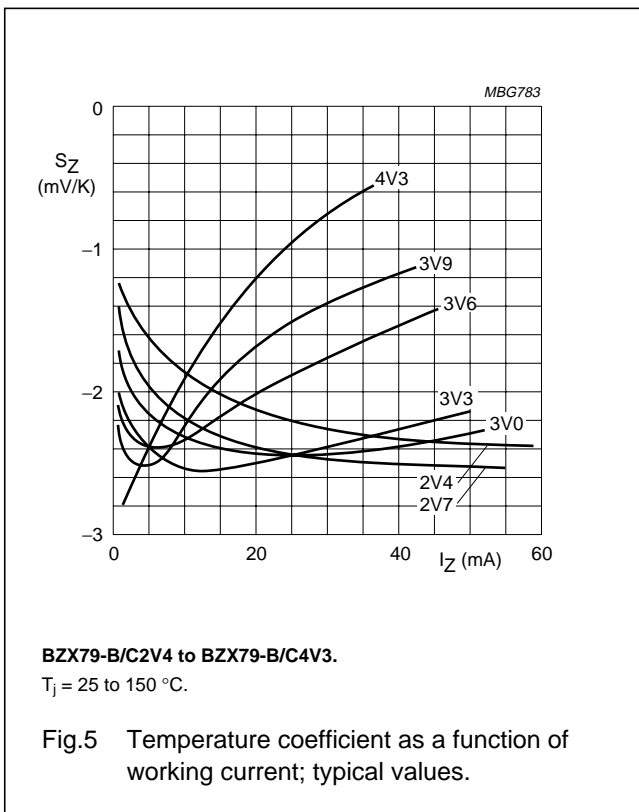
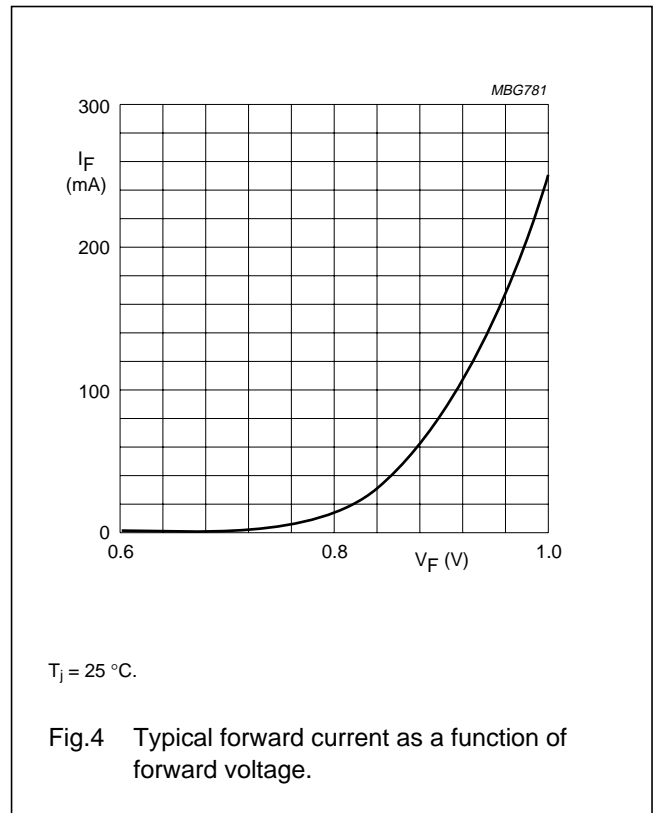
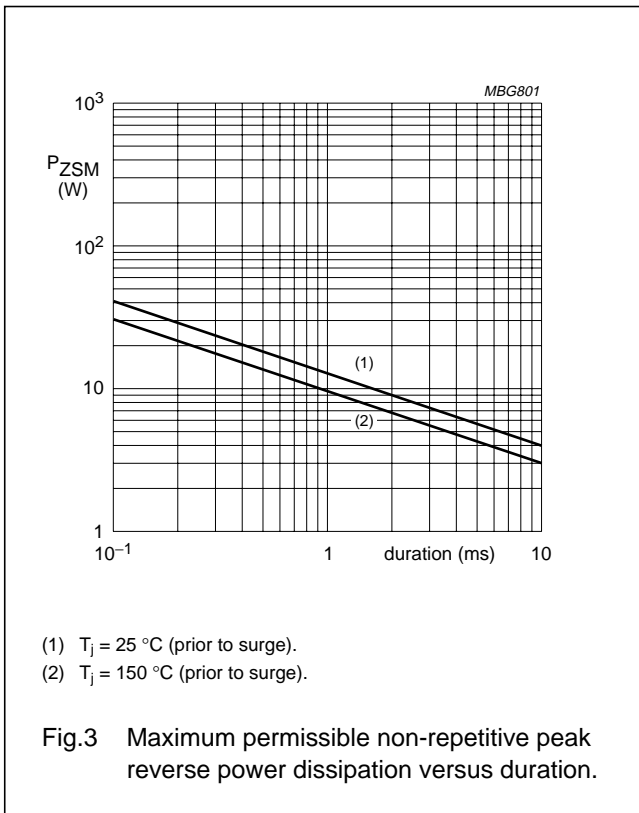

Voltage regulator diodes

BZX79 series

**PACKAGE OUTLINE**

Hermetically sealed glass package; axial leaded; 2 leads

**SOD27**

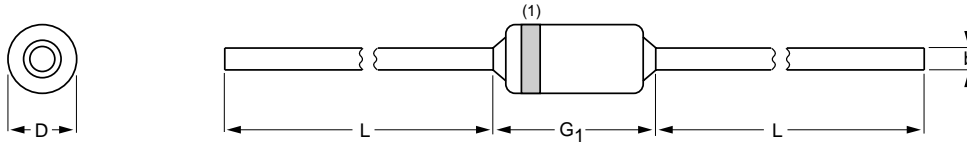

**DIMENSIONS (mm are the original dimensions)**

UNIT	b max.	D max.	G <sub>1</sub> max.	L min.
mm	0.56	1.85	4.25	25.4

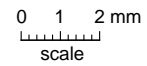

**Note**

1. The marking band indicates the cathode.

OUTLINE VERSION	REFERENCES				EUROPEAN PROJECTION	ISSUE DATE
	IEC	JEDEC	EIAJ			
SOD27	A24	DO-35	SC-40			97-06-09



## Voltage regulator diodes

## BZX79 series

## DATA SHEET STATUS

DATA SHEET STATUS <sup>(1)</sup>	PRODUCT STATUS <sup>(2)</sup>	DEFINITIONS
Objective data	Development	This data sheet contains data from the objective specification for product development. Philips Semiconductors reserves the right to change the specification in any manner without notice.
Preliminary data	Qualification	This data sheet contains data from the preliminary specification. Supplementary data will be published at a later date. Philips Semiconductors reserves the right to change the specification without notice, in order to improve the design and supply the best possible product.
Product data	Production	This data sheet contains data from the product specification. Philips Semiconductors reserves the right to make changes at any time in order to improve the design, manufacturing and supply. Changes will be communicated according to the Customer Product/Process Change Notification (CPCN) procedure SNW-SQ-650A.

## Notes

1. Please consult the most recently issued data sheet before initiating or completing a design.
2. The product status of the device(s) described in this data sheet may have changed since this data sheet was published. The latest information is available on the Internet at URL <http://www.semiconductors.philips.com>.

## DEFINITIONS

**Short-form specification** — The data in a short-form specification is extracted from a full data sheet with the same type number and title. For detailed information see the relevant data sheet or data handbook.

**Limiting values definition** — Limiting values given are in accordance with the Absolute Maximum Rating System (IEC 60134). Stress above one or more of the limiting values may cause permanent damage to the device. These are stress ratings only and operation of the device at these or at any other conditions above those given in the Characteristics sections of the specification is not implied. Exposure to limiting values for extended periods may affect device reliability.

**Application information** — Applications that are described herein for any of these products are for illustrative purposes only. Philips Semiconductors make no representation or warranty that such applications will be suitable for the specified use without further testing or modification.

## DISCLAIMERS

**Life support applications** — These products are not designed for use in life support appliances, devices, or systems where malfunction of these products can reasonably be expected to result in personal injury. Philips Semiconductors customers using or selling these products for use in such applications do so at their own risk and agree to fully indemnify Philips Semiconductors for any damages resulting from such application.

**Right to make changes** — Philips Semiconductors reserves the right to make changes, without notice, in the products, including circuits, standard cells, and/or software, described or contained herein in order to improve design and/or performance. Philips Semiconductors assumes no responsibility or liability for the use of any of these products, conveys no licence or title under any patent, copyright, or mask work right to these products, and makes no representations or warranties that these products are free from patent, copyright, or mask work right infringement, unless otherwise specified.

Voltage regulator diodes

BZX79 series

---

**NOTES**

Voltage regulator diodes

BZX79 series

---

**NOTES**

# ***Philips Semiconductors – a worldwide company***

## **Contact information**

For additional information please visit <http://www.semiconductors.philips.com>. Fax: +31 40 27 24825

For sales offices addresses send e-mail to: [sales.addresses@www.semiconductors.philips.com](mailto:sales.addresses@www.semiconductors.philips.com).

© Koninklijke Philips Electronics N.V. 2002

SCA74

All rights are reserved. Reproduction in whole or in part is prohibited without the prior written consent of the copyright owner.

The information presented in this document does not form part of any quotation or contract, is believed to be accurate and reliable and may be changed without notice. No liability will be accepted by the publisher for any consequence of its use. Publication thereof does not convey nor imply any license under patent- or other industrial or intellectual property rights.

Printed in The Netherlands

613514/03/pp12

Date of release: 2002 Feb 27

Document order number: 9397 750 09387

*Let's make things better.*

**Philips  
Semiconductors**



**PHILIPS**