

Overvoltage protected AC switch

Features

- Triac with overvoltage crowbar technology
- Low I_{GT} (<10 mA) or high immunity (I_{GT} <35 mA) version
- High noise immunity: static $dV/dt > 2000$ V/ μ s

Benefits

- Enables equipment to meet IEC 61000-4-5
- High off-state reliability with planar technology
- Need no external over voltage protection
- Reduces the power passive component count
- High immunity against fast transients described in IEC 61000-4-4 standards

Applications

- AC mains static switching in appliance and industrial control systems
- Drive of medium power AC loads such as:
 - Universal motor of washing machine drum
 - Compressor for fridge or air conditioner

Description

The ACST12 series belongs to the ACS™/ACST power switch family built with A.S.D.® (application specific discrete) technology. This high performance device is suited to home appliances or industrial systems and drives loads up to 12 A.

This ACST12 switch embeds a Triac structure and a high voltage clamping device able to absorb the inductive turn-off energy and withstand line transients such as those described in the IEC 61000-4-5 standard. The ACST1210-7 needs a low gate current to be activated ($I_{GT} < 10$ mA) and still provides a high electrical noise immunity complying with the IEC 61000-4-4 standard. The ACST1235-7 offers an extremely high static dV/dt immunity of 2 kV/ μ s minimum.

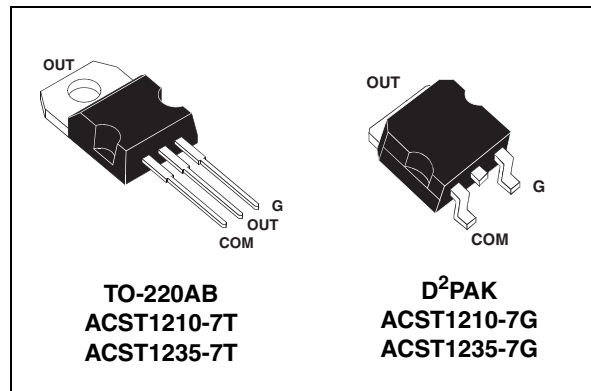

Figure 1. Functional diagram

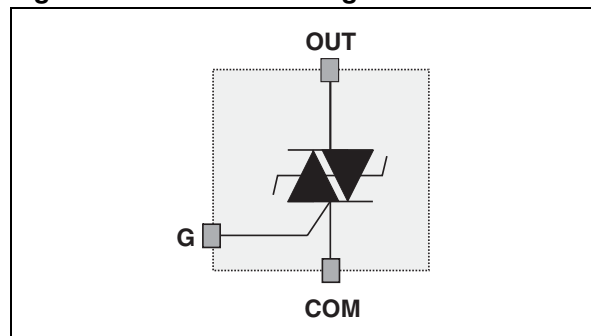

Table 1. Device summary

Symbol	Value	Unit
$I_{T(RMS)}$	12	A
V_{DRM}/V_{RRM}	700	V
I_{GT}	10 or 35	mA

™: ACS is a trademark of STMicroelectronics

®: A.S.D. is a registered trademark of STMicroelectronics

1 Characteristics

Table 2. Absolute ratings (limiting values)

Symbol	Parameter			Value	Unit
I _{T(RMS)}	On-state rms current full sine wave	TO-220AB D ² PAK	T _c = 104 °C	12	A
		D ² PAK with 1cm ² of Cu	T _{amb} = 47 °C	2	
I _{TSM}	Non repetitive surge peak on-state current T _j initial = 25 °C, (full cycle sine wave)	F = 60 Hz	t _p = 16.7 ms	126	A
		F = 50 Hz	t _p = 20.0 ms	120	A
I ² t	I ² t for fuse selection		t _p = 10 ms	95	A ² s
dI/dt	Critical rate of rise on-state current I _G = 2 x I _{GT} , (t _r ≤ 100 ns)	F = 120 Hz	T _j = 125 °C	100	A/μs
V _{PP}	Non repetitive line peak pulse voltage ⁽¹⁾		T _j = 125 °C	2	kV
P _{G(AV)}	Average gate power dissipation		T _j = 125 °C	0.1	W
P _{GM}	Peak gate power dissipation (t _p = 20 μs)		T _j = 125 °C	10	W
I _{GM}	Peak gate current (t _p = 20 μs)		T _j = 125 °C	1.6	A
T _{stg}	Storage temperature range			- 40 to + 150	°C
T _j	Operating junction temperature range			- 40 to + 125	°C
T _l	maximum lead soldering temperature during 10 s (at 3 mm from plastic case)			260	°C

1. According to test described in IEC 61000-4-5 standard and [Figure 19](#)

Table 3. Electrical characteristics

Symbol	Test conditions	Quadrant	T _j		Value		Unit
					ACST1210-7	ACST1235-7	Unit
I _{GT} ⁽¹⁾	V _{OUT} = 12 V, R _L = 33 Ω	I - II - III	25 °C	MAX.	10	35	mA
V _{GT}	V _{OUT} = 12 V, R _L = 33 Ω	I - II - III	25 °C	MAX.	1.0		V
V _{GD}	V _{OUT} = V _{DRM} , R _L = 3.3 Ω	I - II - III	125 °C	MIN.	0.2		V
I _H ⁽²⁾	I _{OUT} = 500 mA		25 °C	MAX.	30	50	mA
I _L	I _G = 1.2 x I _{GT}	I - II - III	25 °C	MAX.	50	70	mA
dV/dt ⁽²⁾	V _{OUT} = 67% V _{DRM} , gate open		125 °C	MIN.	200	2000	V/μs
(dI/dt) _c ⁽²⁾	(dV/dt) _c = 15 V/μs		125 °C	MIN.	5.3		A/ms
	Without snubber			MIN.		14	
V _{CL}	I _{CL} = 0.1 mA, t _p = 1 ms		25 °C	MIN.	850		V

1. Minimum I_{GT} is guaranteed at 5% of I_{GT} max
2. For both polarities of OUT pin referenced to COM pin

Table 4. Static characteristics

Symbol	Test conditions		Value	Unit
$V_{TM}^{(1)}$	$I_{OUT} = 17\text{ A}$, $t_p = 500\ \mu\text{s}$	$T_j = 25\text{ }^\circ\text{C}$	MAX. 1.5	V
$V_{T0}^{(1)}$	Threshold voltage	$T_j = 125\text{ }^\circ\text{C}$	MAX. 0.9	V
$R_d^{(1)}$	Dynamic resistance	$T_j = 125\text{ }^\circ\text{C}$	MAX. 30	m Ω
I_{DRM} I_{RRM}	$V_{OUT} = V_{DRM}/V_{RRM}$	$T_j = 25\text{ }^\circ\text{C}$	MAX. 20	μA
		$T_j = 125\text{ }^\circ\text{C}$		1.5

1. For both polarities of OUT pin referenced to COM pin

Table 5. Thermal characteristics

Symbol	Parameter		Value	Unit
$R_{th(j-c)}$	Junction to case (AC)	TO-220AB	1.5	$^\circ\text{C/W}$
		D ² PAK		$^\circ\text{C/W}$
$R_{th(j-a)}$	Junction to ambient	TO-220AB	60	$^\circ\text{C/W}$
		D ² PAK with 1 cm ² of Cu	45	$^\circ\text{C/W}$

Figure 2. Maximum power dissipation versus on-state rms current (full cycle)

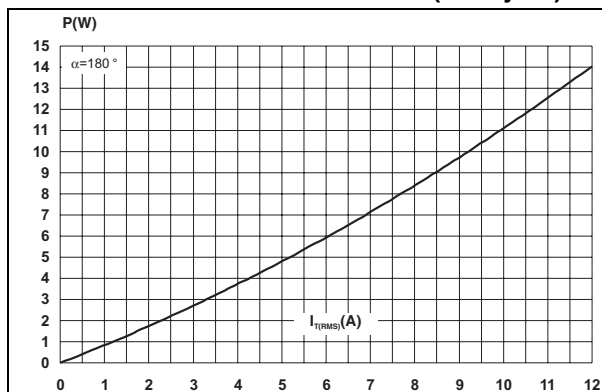

Figure 3. On-state rms current versus case temperature (full cycle)

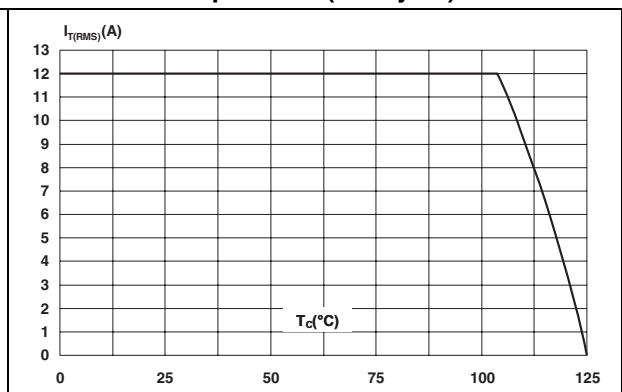

Figure 4. On-state rms current versus ambient temperature (free air convection full cycle)

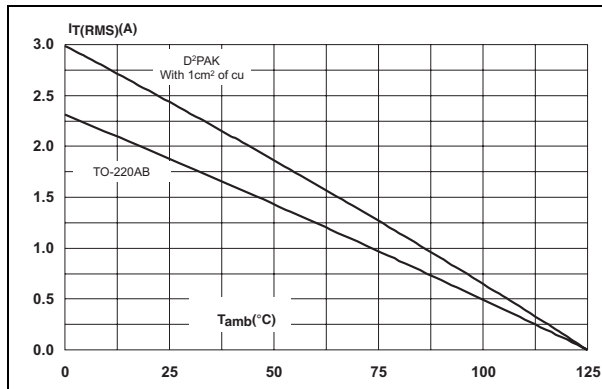

Figure 5. Relative variation of thermal impedance versus pulse duration

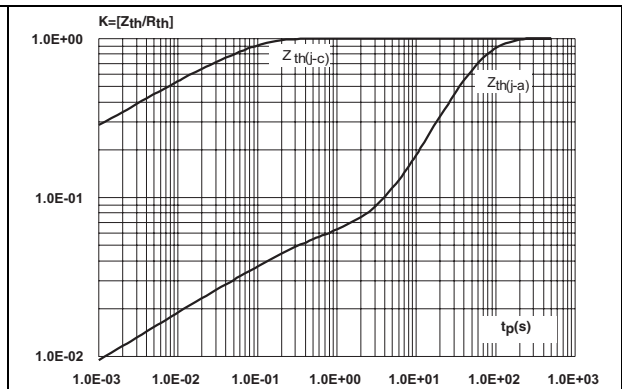

Figure 6. On-state characteristics (maximum values)

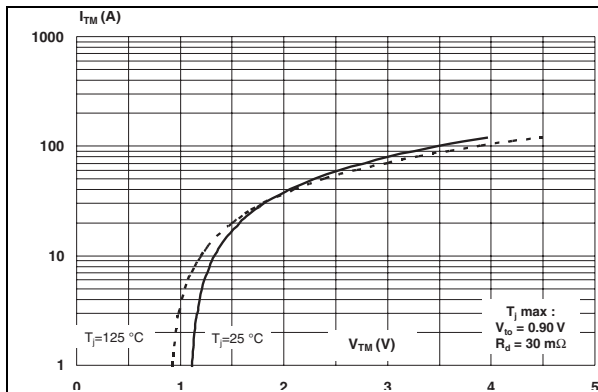

Figure 7. Non repetitive surge peak on-state current versus number of cycles (T_j initial = 25 °C)

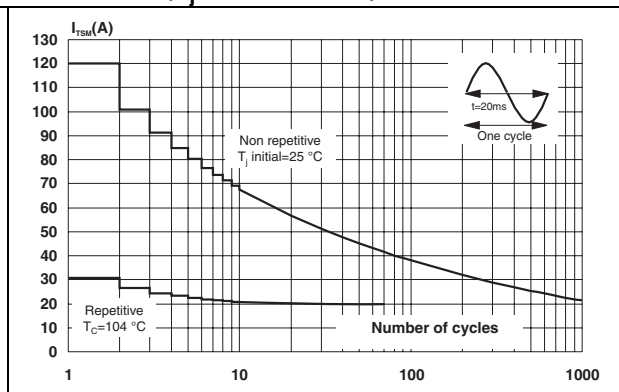

Figure 8. Non repetitive surge peak on-state current for a sinusoidal pulse and corresponding value of I^2t

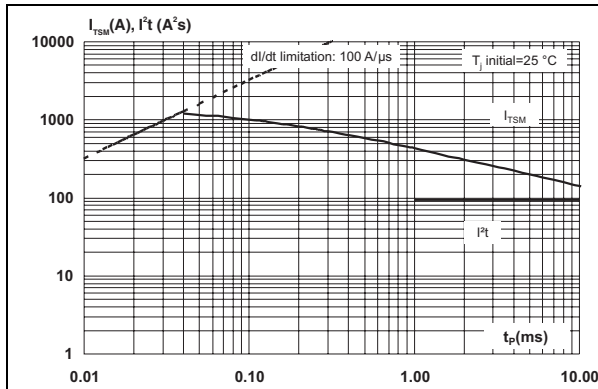

Figure 9. Relative variation of gate triggering current and gate voltage versus junction temperature (typical value)

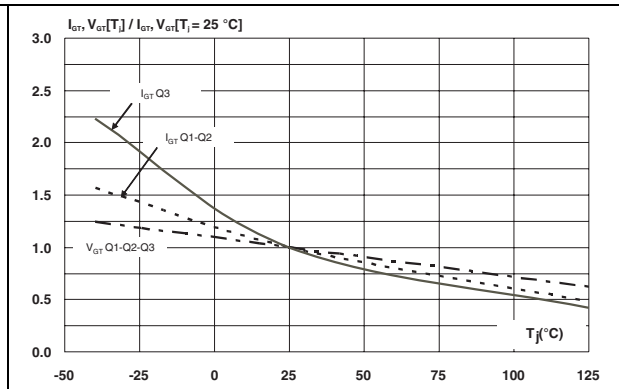

Figure 10. Relative variation of holding current (I_H) and latching current (I_L) versus junction temperature

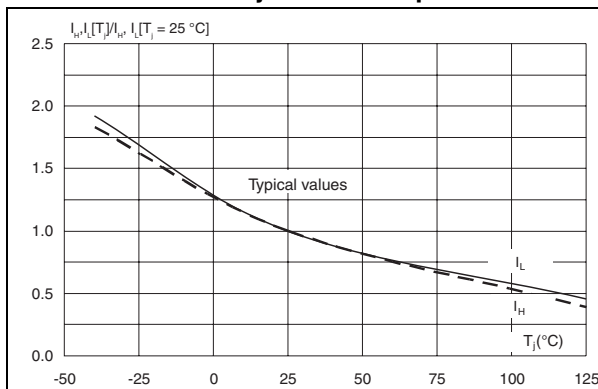

Figure 11. Relative variation of critical rate of decrease of main current (di/dt)c versus $(dV/dt)c$

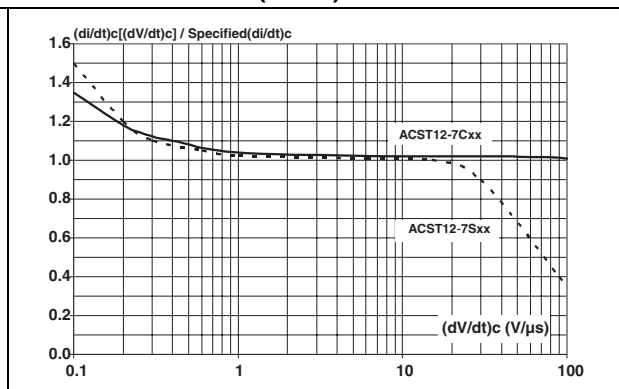

Figure 12. Relative variation of critical rate of decrease of main current versus junction temperature

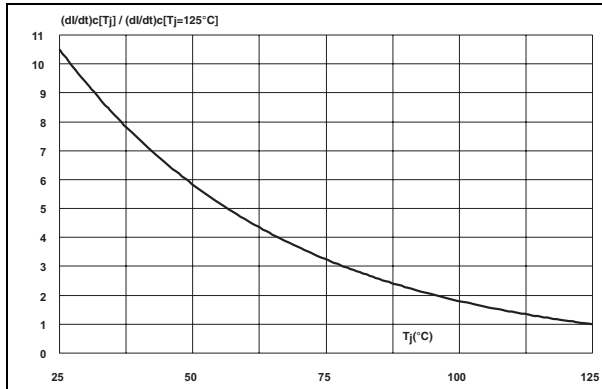

Figure 13. Relative variation of static dV/dt immunity versus junction temperature

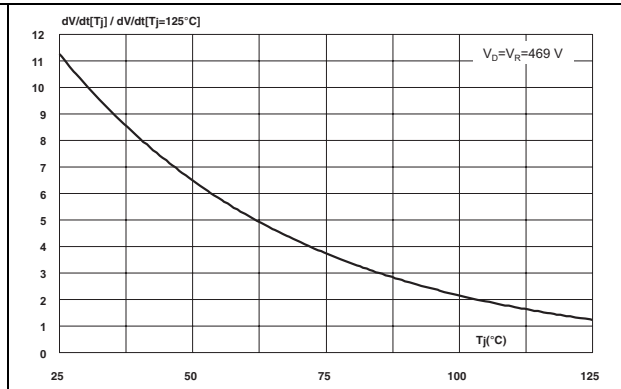

Figure 14. Relative variation of maximum clamping voltage, V_{CL} versus junction temperature

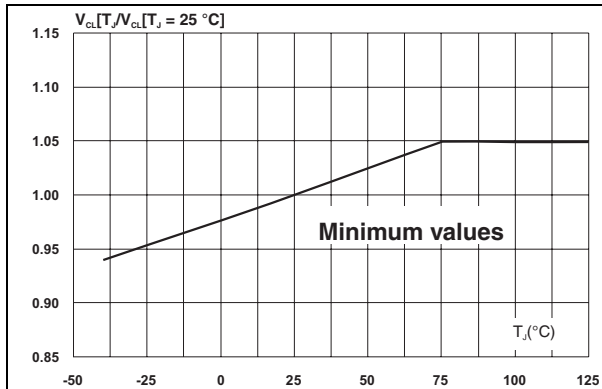
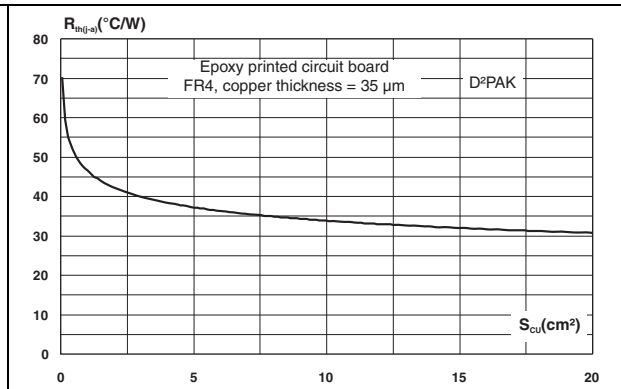

Figure 15. Variation of thermal resistance junction to ambient versus copper surface under tab



2 Application information

2.1 Typical application description

The ACST12 device has been designed to control medium power load, such as AC motors in home appliances. Thanks to its thermal and turn off commutation performances, the ACST12 switch is able to drive an inductive load up to 12 A with no turn off additional snubber. It also provides high thermal performances in static and transient modes such as the compressor inrush current or high torque operating conditions of an AC motor. Thanks to its low gate triggering current level, the ACST1210-7 can be driven directly by a MCU through a simple gate resistor as shown in [Figure 16](#).

Figure 16. Compressor control – typical diagrams

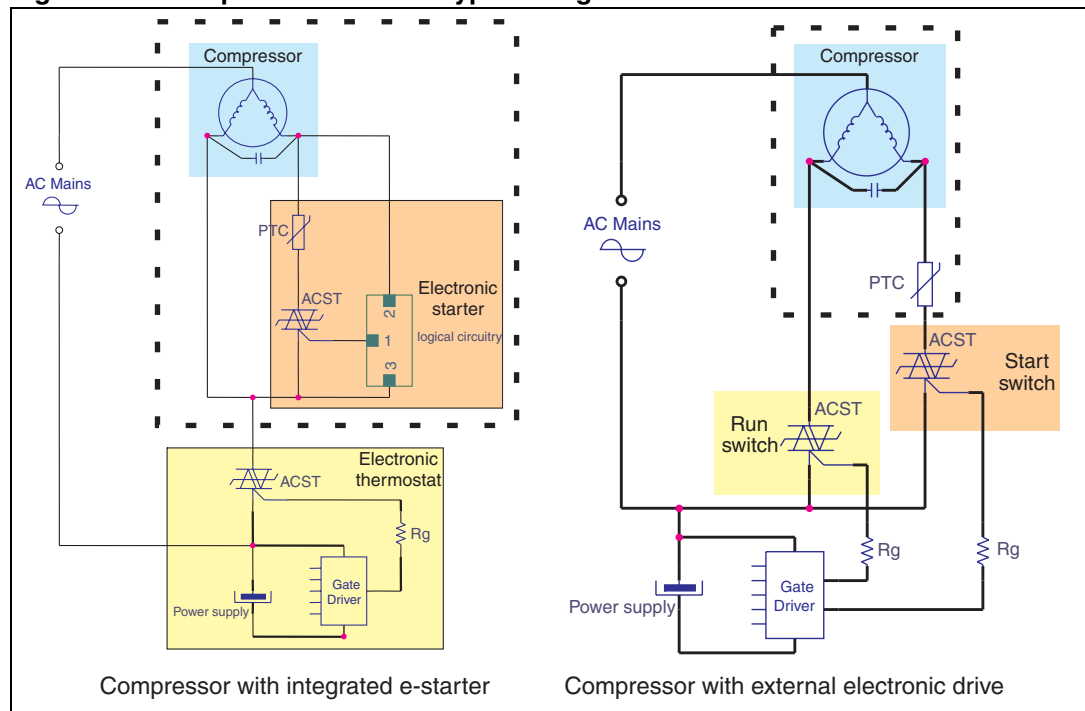

Figure 18. Overvoltage ruggedness test circuit for resistive and inductive loads for IEC 61000-4-5 standards

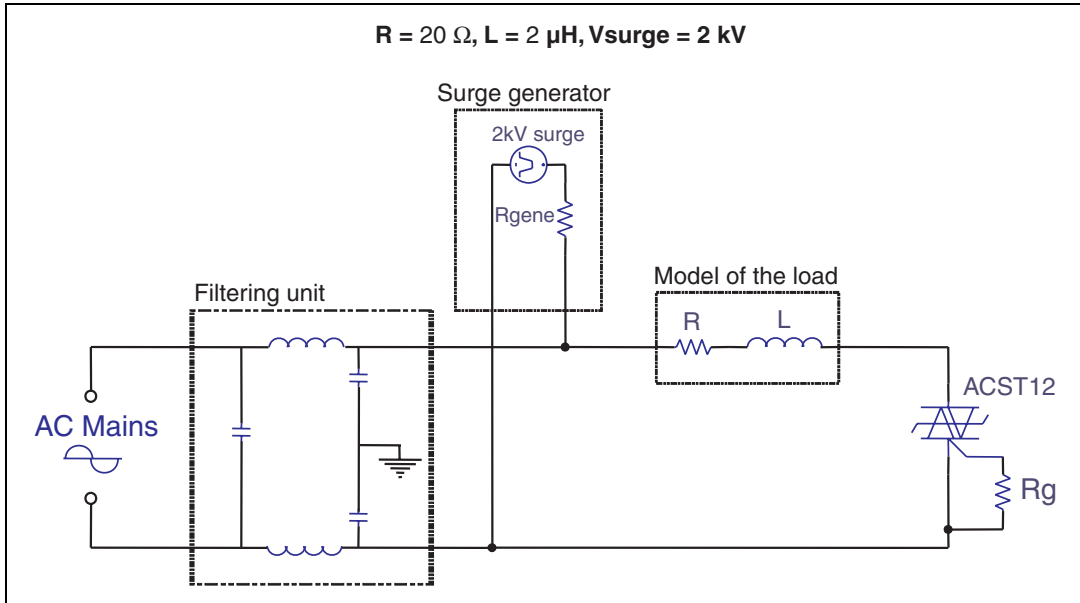
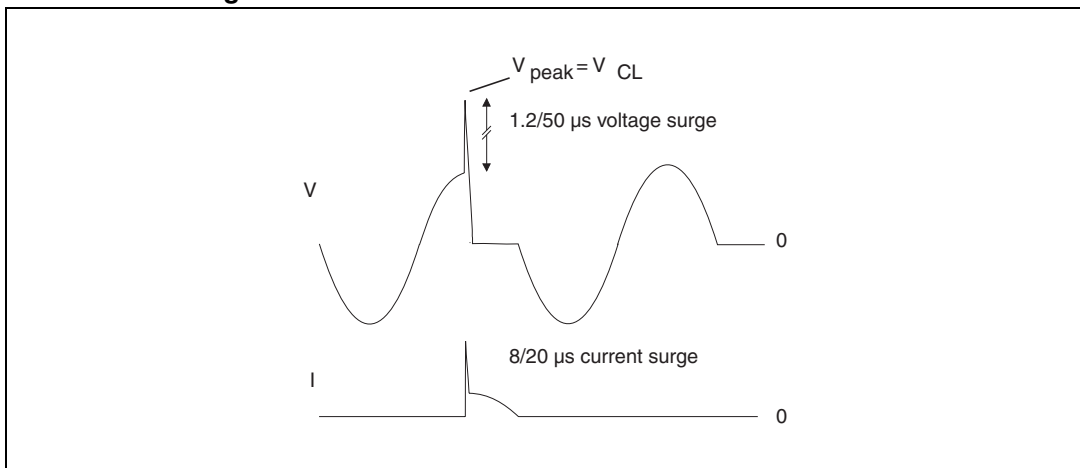
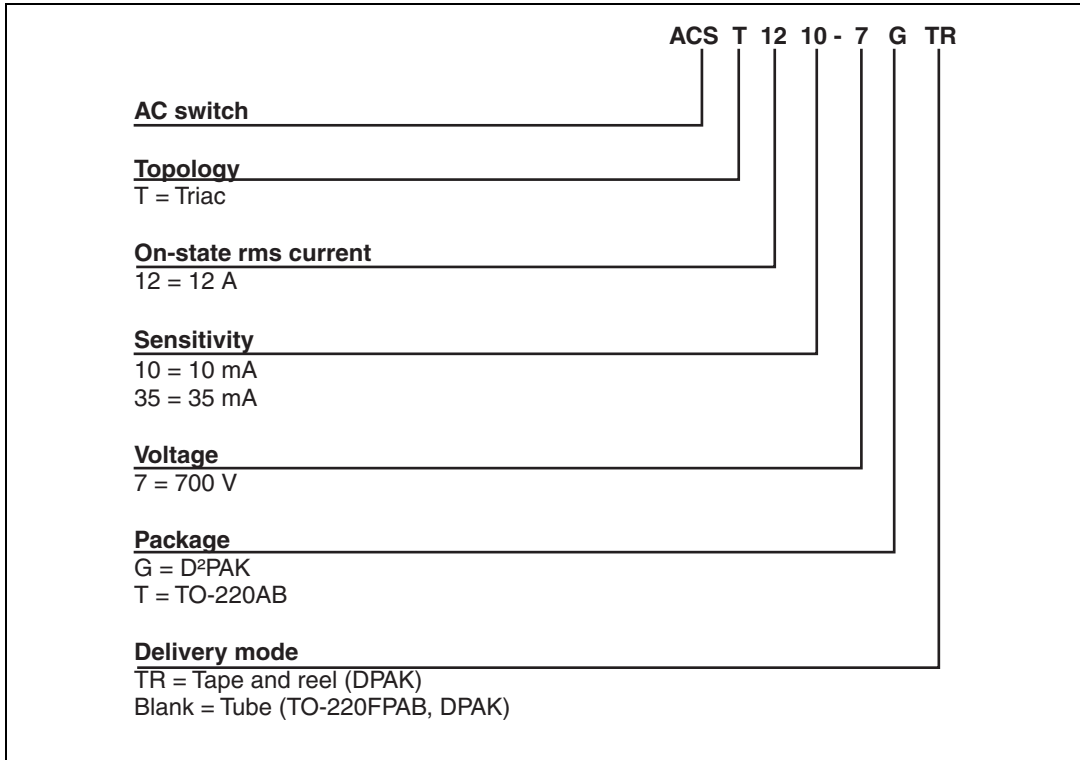

Figure 19. Typical voltage and current waveforms across the ACST12 during IEC 61000-4-5 standard test



3 Ordering information scheme

Figure 20. Ordering information scheme



4 Package information

- Epoxy meets UL94, V0
- Recommended torque (TO-220AB): 0.4 to 0.6 N·m

In order to meet environmental requirements, ST offers these devices in different grades of ECOPACK® packages, depending on their level of environmental compliance. ECOPACK® specifications, grade definitions and product status are available at: www.st.com. ECOPACK® is an ST trademark.

Table 6. TO-220AB dimensions

Ref.	Dimensions			
	Millimeters		Inches	
	Min.	Max.	Min.	Max.
A	4.40	4.60	0.173	0.181
C	1.23	1.32	0.048	0.051
D	2.40	2.72	0.094	0.107
E	0.49	0.70	0.019	0.027
F	0.61	0.88	0.024	0.034
F1	1.14	1.70	0.044	0.066
F2	1.14	1.70	0.044	0.066
G	4.95	5.15	0.194	0.202
G1	2.40	2.70	0.094	0.106
H2	10	10.40	0.393	0.409
L2	16.4 typ.		0.645 typ.	
L4	13	14	0.511	0.551
L5	2.65	2.95	0.104	0.116
L6	15.25	15.75	0.600	0.620
L7	6.20	6.60	0.244	0.259
L9	3.50	3.93	0.137	0.154
M	2.6 typ.		0.102 typ.	
Diam.	3.75	3.85	0.147	0.151

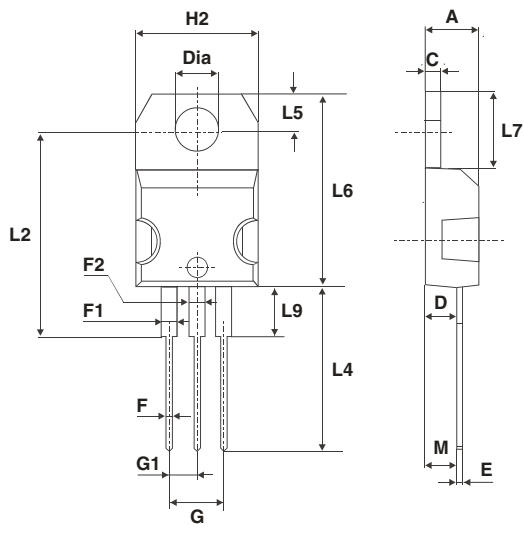
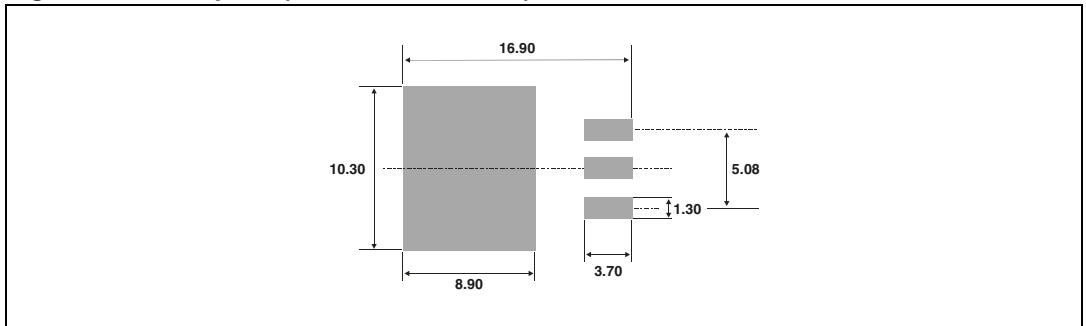

Table 7. D²PAK dimensions

Ref.	Dimensions					
	Millimeters			Inches		
	Min.	Typ.	Max.	Min.	Typ.	Max.
A	4.30		4.60	0.169		0.181
A1	2.49		2.69	0.098		0.106
A2	0.03		0.23	0.001		0.009
B	0.70		0.93	0.027		0.037
B2	1.25	1.40		0.048	0.055	
C	0.45		0.60	0.017		0.024
C2	1.21		1.36	0.047		0.054
D	8.95		9.35	0.352		0.368
E	10.00		10.28	0.393		0.405
G	4.88		5.28	0.192		0.208
L	15.00		15.85	0.590		0.624
L2	1.27		1.40	0.050		0.055
L3	1.40		1.75	0.055		0.069
R	0.40			0.016		
V2	0°		8°	0°		8°

Figure 21. Footprint (dimensions in mm)



5 Ordering information

Table 8. Ordering information

Order code	Marking	Package	Weight	Base qty	Packing mode
ACST1210-7T	ACST12107	TO-220AB	2.3 g	50	Tube
ACST1210-7G		D ² PAK	1.5 g	50	Tube
ACST1210-7GTR		D ² PAK	1.5 g	1000	Tape and reel
ACST1235-7T	ACST12357	TO-220AB	2.3 g	50	Tube
ACST1235-7G		D ² PAK	1.5 g	50	Tube
ACST1235-7GTR		D ² PAK	1.5 g	1000	Tape and reel

6 Revision history

Table 9. Document revision history

Date	Revision	Changes
02-Dec-2008	1	First issue.
13-Apr-2010	2	Updated ECOPACK statement. Reformatted for consistency with other datasheets in this product class.
01-Jul-2010	3	Updated Figure 20 .
07-Dec-2010	4	Updated Table 3 .

Please Read Carefully:

Information in this document is provided solely in connection with ST products. STMicroelectronics NV and its subsidiaries ("ST") reserve the right to make changes, corrections, modifications or improvements, to this document, and the products and services described herein at any time, without notice.

All ST products are sold pursuant to ST's terms and conditions of sale.

Purchasers are solely responsible for the choice, selection and use of the ST products and services described herein, and ST assumes no liability whatsoever relating to the choice, selection or use of the ST products and services described herein.

No license, express or implied, by estoppel or otherwise, to any intellectual property rights is granted under this document. If any part of this document refers to any third party products or services it shall not be deemed a license grant by ST for the use of such third party products or services, or any intellectual property contained therein or considered as a warranty covering the use in any manner whatsoever of such third party products or services or any intellectual property contained therein.

UNLESS OTHERWISE SET FORTH IN ST'S TERMS AND CONDITIONS OF SALE ST DISCLAIMS ANY EXPRESS OR IMPLIED WARRANTY WITH RESPECT TO THE USE AND/OR SALE OF ST PRODUCTS INCLUDING WITHOUT LIMITATION IMPLIED WARRANTIES OF MERCHANTABILITY, FITNESS FOR A PARTICULAR PURPOSE (AND THEIR EQUIVALENTS UNDER THE LAWS OF ANY JURISDICTION), OR INFRINGEMENT OF ANY PATENT, COPYRIGHT OR OTHER INTELLECTUAL PROPERTY RIGHT.

UNLESS EXPRESSLY APPROVED IN WRITING BY AN AUTHORIZED ST REPRESENTATIVE, ST PRODUCTS ARE NOT RECOMMENDED, AUTHORIZED OR WARRANTED FOR USE IN MILITARY, AIR CRAFT, SPACE, LIFE SAVING, OR LIFE SUSTAINING APPLICATIONS, NOR IN PRODUCTS OR SYSTEMS WHERE FAILURE OR MALFUNCTION MAY RESULT IN PERSONAL INJURY, DEATH, OR SEVERE PROPERTY OR ENVIRONMENTAL DAMAGE. ST PRODUCTS WHICH ARE NOT SPECIFIED AS "AUTOMOTIVE GRADE" MAY ONLY BE USED IN AUTOMOTIVE APPLICATIONS AT USER'S OWN RISK.

Resale of ST products with provisions different from the statements and/or technical features set forth in this document shall immediately void any warranty granted by ST for the ST product or service described herein and shall not create or extend in any manner whatsoever, any liability of ST.

ST and the ST logo are trademarks or registered trademarks of ST in various countries.

Information in this document supersedes and replaces all information previously supplied.

The ST logo is a registered trademark of STMicroelectronics. All other names are the property of their respective owners.

© 2010 STMicroelectronics - All rights reserved

STMicroelectronics group of companies

Australia - Belgium - Brazil - Canada - China - Czech Republic - Finland - France - Germany - Hong Kong - India - Israel - Italy - Japan - Malaysia - Malta - Morocco - Philippines - Singapore - Spain - Sweden - Switzerland - United Kingdom - United States of America

www.st.com