

# Xinger®

## Ultra Low Profile 0805 3 dB, 90° Hybrid Coupler

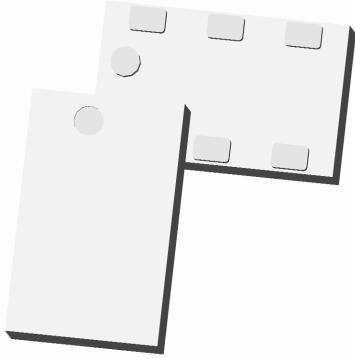

### Description

The C0810J5003AHF is a low cost, low profile sub-miniature high performance 3 dB coupler in an easy to use surface mount package. It is designed for 800 – 1000MHz applications including: GSM, WCDMA, CDMA and 900MHz ISM applications. The C0810J5003AHF is ideal for balanced power and low noise amplifiers, plus signal distribution and other applications where low insertion loss and tight amplitude and phase balance are required. The C0810J5003AHF is available on tape and reel for pick and place high volume manufacturing.

All of the Xinger components are constructed from ceramic filled PTFE composites which possess excellent electrical and mechanical stability having X and Y thermal coefficient of expansion (CTE) of 17 ppm/°C.

### Detailed Electrical Specifications: Specifications subject to change without notice.

Features:	Parameter	Extended Band			Nominal Band			25°C	
		Min	Typ	Max	Min	Typ	Max	Unit	
<ul style="list-style-type: none"> <li>• 800 – 1000 MHz</li> <li>• 0.68 mm Height Profile</li> <li>• GSM, WCDMA &amp; 900 MHz ISM</li> <li>• Surface Mountable</li> <li>• Tape &amp; Reel</li> <li>• RoHS Compliant</li> <li>• Halogen-Free</li> </ul>	Frequency	700		1000	800		1000	MHz	
	Port Impedance		50			50		Ω	
	Return Loss	18	28		21	31		Ω	
	Isolation	18	21		18	23		dB	
	Insertion Loss*		0.5	0.6		0.5	0.6	dB	
	Amplitude Balance		0.6	0.9		0.6	0.9	dB	
	Phase Balance		4	7		4	7	Degrees	
	Power Handling			4			4	Watts	
	Operating Temperature		-55		+85		-55	+85	°C

### Outline Drawing

Top View (Near-side)

Orientation Marker Denotes Pin Location

Side View

Bottom View (Far-side)

Orientation Marker Denotes Pin Location

Pin	Designation
1	Input
2	GND
3	Isolated
4	Direct
5	GND
6	Coupled

Dimensions are in Inches [Millimeters]  
Mechanical Outline

Tolerances are Non-Cumulative

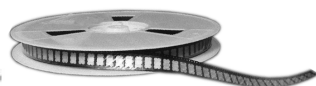

## Typical Broadband Performance: 500 MHz. to 8000 MHz.

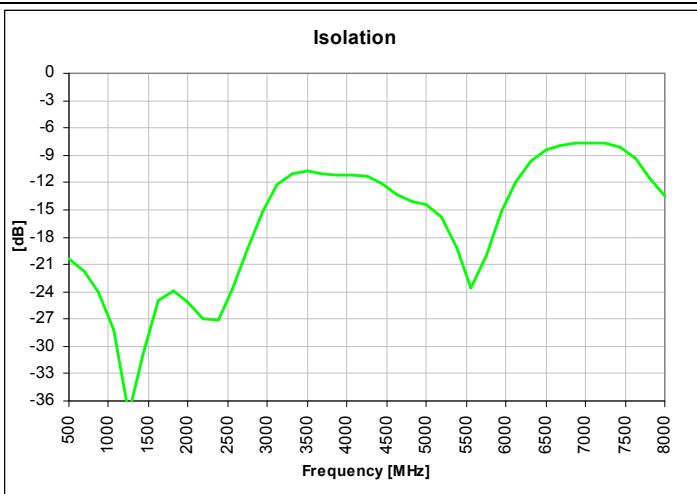
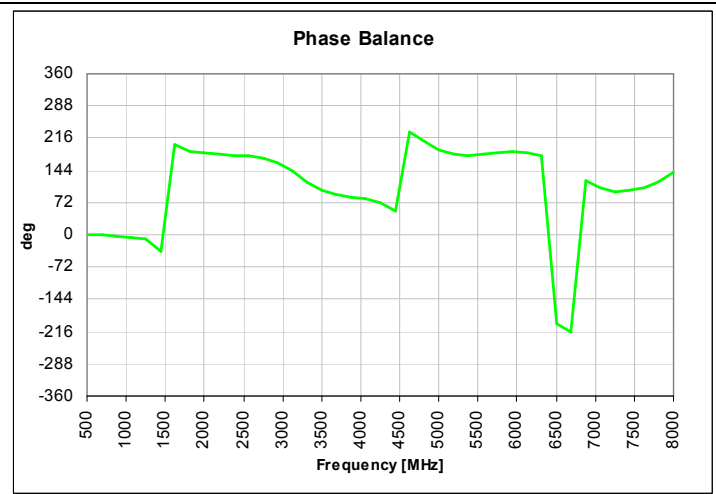
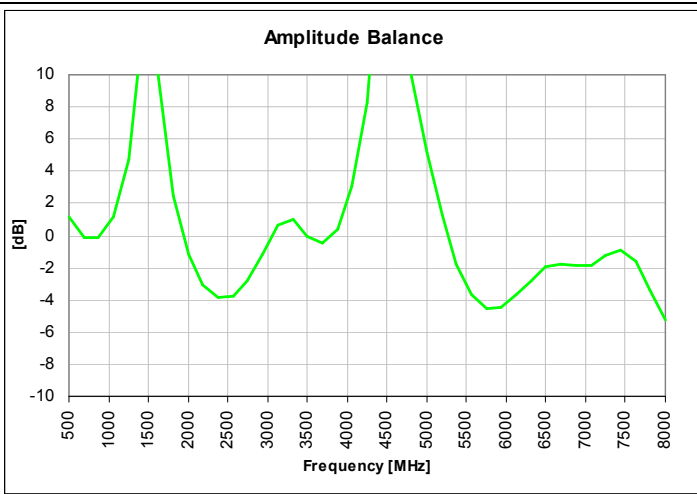
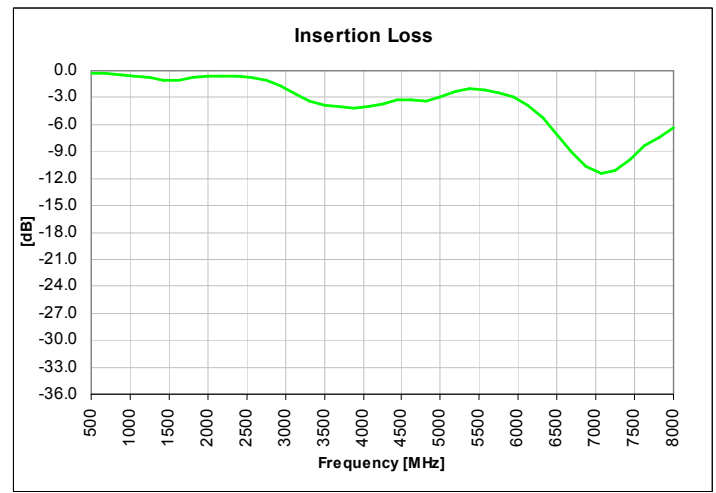
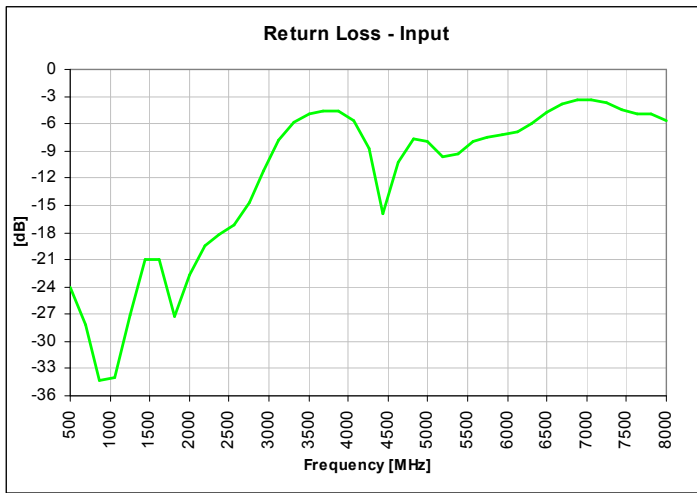

USA/Canada: (315) 432-8909  
 Toll Free: (800) 411-6596  
 Europe: +44 2392-232392

Available on Tape and Reel for Pick and Place Manufacturing.

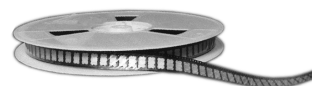

**Anaren**  
 What'll we think of next?™

### Typical Performance: 700 MHz. to 1100 MHz.

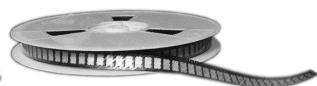
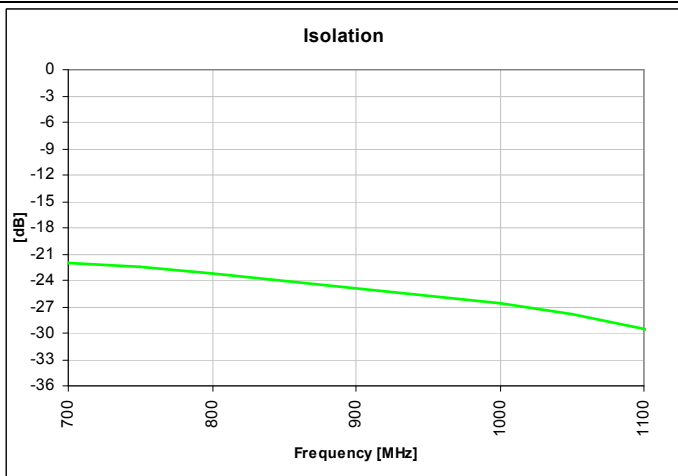
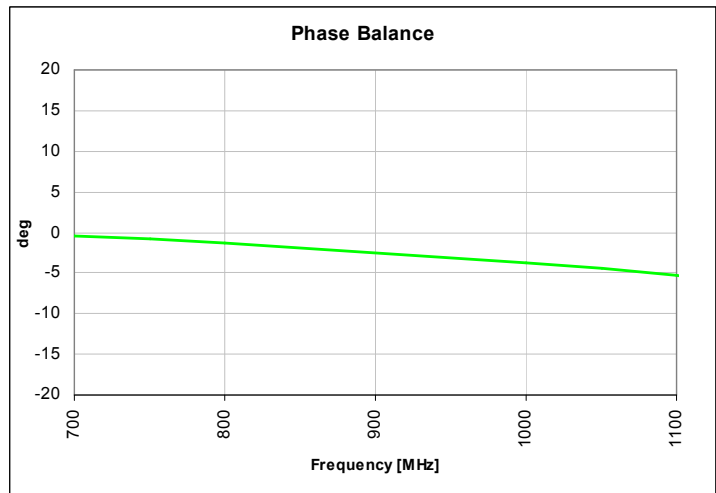
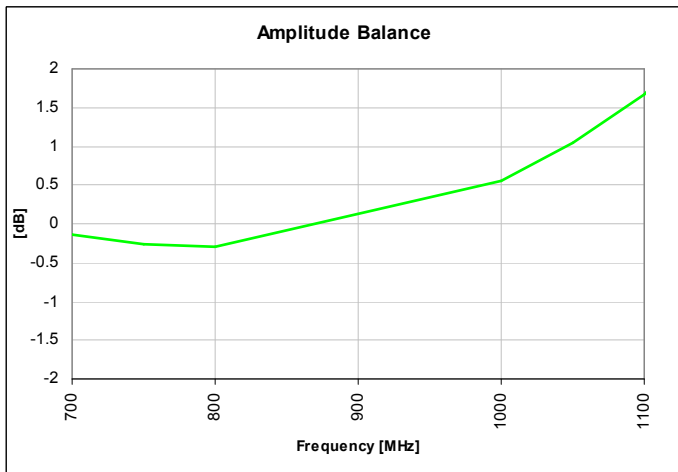
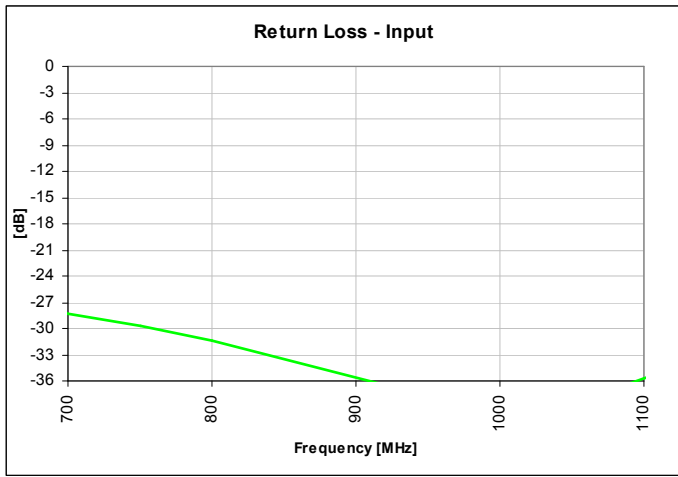

## Mounting Configuration:

In order for Xinger surface mount components to work optimally, the proper impedance transmission lines must be used to connect to the RF ports. If this condition is not satisfied, insertion loss, Isolation and VSWR may not meet published specifications.

All of the Xinger components are constructed from ceramic filled PTFE composites which possess excellent electrical and mechanical stability having X and Y thermal coefficient of expansion (CTE) of 17 ppm/°C.

An example of the PCB footprint used in the testing of these parts is shown below. In specific designs, the transmission line widths need to be adjusted to the unique dielectric coefficients and thicknesses as well as varying pick and place equipment tolerances.

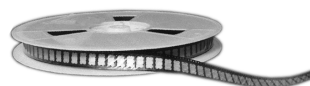
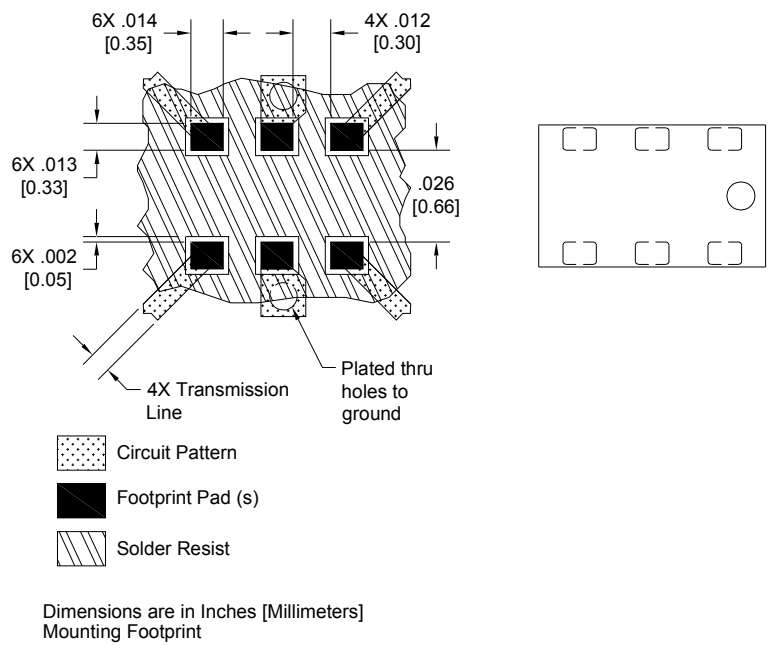

### Packaging and Ordering Information

Parts are available in reel and are packaged per EIA 481-2. Parts are oriented in tape and reel as shown below. Minimum order quantities are 4000 per reel. See Model Numbers below for further ordering information.

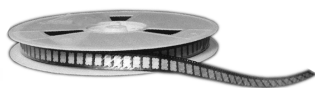
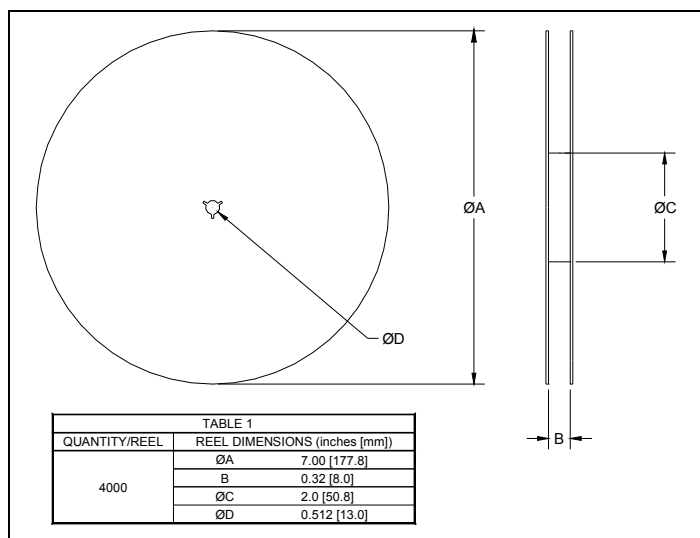
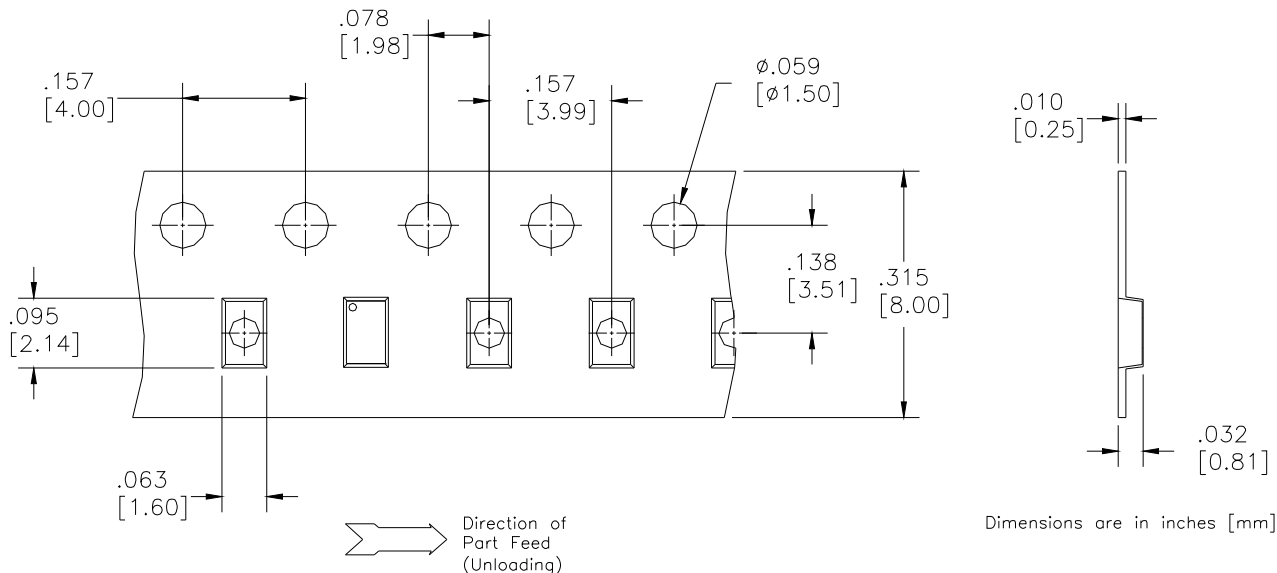

# Mouser Electronics

Authorized Distributor

Click to View Pricing, Inventory, Delivery & Lifecycle Information:

[Anaren:](#)

[C0810J5003AHF](#)