

Automotive ultrafast recovery diode

Datasheet - production data

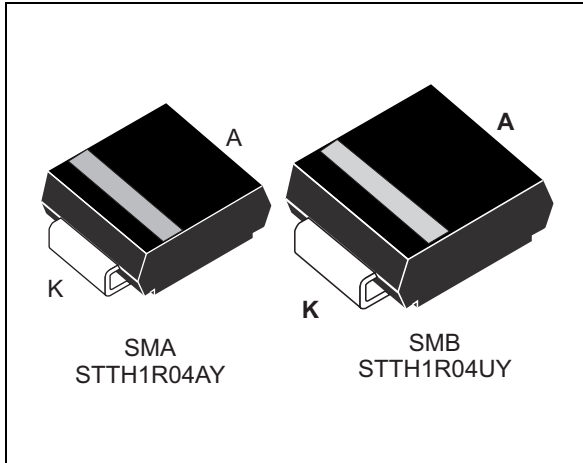

Features

- Negligible switching losses
- Low forward and reverse recovery times
- High junction temperature
- AEC-Q101 qualified
- ECOPACK[®]2 compliant component

Description

The STTH1R04-Y series uses ST's new 400 V planar Pt doping technology. Specially suited for switching mode base drive and transistor circuits.

Packaged in surface mount packages, this device is intended for use in low voltage, high frequency inverters, free wheeling and polarity protection for all automotive application.

Table 1. Device summary

Symbol	Value
$I_{F(AV)}$	1 A
V_{RRM}	400 V
$T_j (max)$	175 °C
$V_F (typ)$	0.9 V
$t_{rr} (typ)$	14 ns

1 Characteristics

Table 2. Absolute ratings (limiting values at 25 °C, unless otherwise specified)

Symbol	Parameter		Value	Unit	
V_{RRM}	Repetitive peak reverse voltage		400	V	
$I_{F(AV)}$	Average forward current, $\delta = 0.5$	SMA	1.0	A	
		SMB			
I_{FSM}	Surge non repetitive forward current	$T_{lead} = 130\text{ °C}$		30	A
		$T_{lead} = 140\text{ °C}$			
T_{stg}	Storage temperature range		-65 to +175	°C	
T_j	Operating junction temperature ⁽¹⁾		-40 to 175	°C	

1. On infinite heatsink with 10 mm lead length

Table 3. Thermal parameters

Symbol	Parameter		Value	Unit
$R_{th(j-l)}$	Junction to lead	SMA	30	°C/W
		SMB	25	

Table 4. Static electrical characteristics

Symbol	Parameter	Test conditions		Min	Typ	Max	Unit
$I_R^{(1)}$	Reverse leakage current	$T_j = 25\text{ °C}$	$V_R = V_{RRM}$			5	μA
		$T_j = 125\text{ °C}$			5	50	
$V_F^{(2)}$	Forward voltage drop	$T_j = 25\text{ °C}$	$I_F = 1.0\text{ A}$			1.6	V
		$T_j = 100\text{ °C}$			1.05	1.3	
		$T_j = 150\text{ °C}$			0.9	1.15	

1. Pulse test: $t_p = 5\text{ ms}$, $\delta < 2\%$
2. Pulse test: $t_p = 380\text{ }\mu\text{s}$, $\delta < 2\%$

To evaluate the conduction losses use the following equation:

$$P = 0.9 \times I_{F(AV)} + 0.250 \times I_F^2_{(RMS)}$$

Table 5. Dynamic characteristics

Symbol	Parameter	Test conditions	Min	Typ	Max	Unit
t_{rr}	Reverse recovery time	$I_F = 1\text{ A}$, $di_F/dt = -50\text{ A}/\mu\text{s}$, $V_R = 30\text{ V}$, $T_j = 25\text{ }^\circ\text{C}$			30	ns
		$I_F = 1\text{ A}$, $di_F/dt = -100\text{ A}/\mu\text{s}$, $V_R = 30\text{ V}$, $T_j = 25\text{ }^\circ\text{C}$		14	20	
I_{RM}	Reverse recovery current	$I_F = 1\text{ A}$, $di_F/dt = -200\text{ A}/\mu\text{s}$, $V_R = 320\text{ V}$, $T_j = 125\text{ }^\circ\text{C}$		2.5	3.5	A
t_{fr}	Forward recovery time	$I_F = 1\text{ A}$ $di_F/dt = 100\text{ A}/\mu\text{s}$ $V_{FR} = 1.1 \times V_{Fmax}$, $T_j = 25\text{ }^\circ\text{C}$			50	ns
V_{FP}	Forward recovery voltage	$I_F = 1\text{ A}$, $di_F/dt = 100\text{ A}/\mu\text{s}$, $T_j = 25\text{ }^\circ\text{C}$		2.9		V

Figure 1. Conduction losses versus average forward current

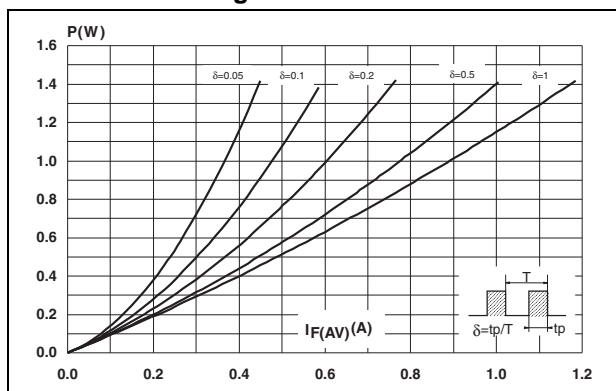

Figure 2. Forward voltage drop versus forward current

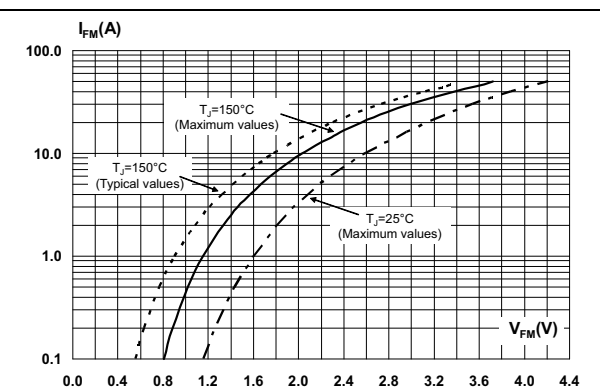

Figure 3. Relative variation of thermal impedance junction to ambient versus pulse duration, SMA

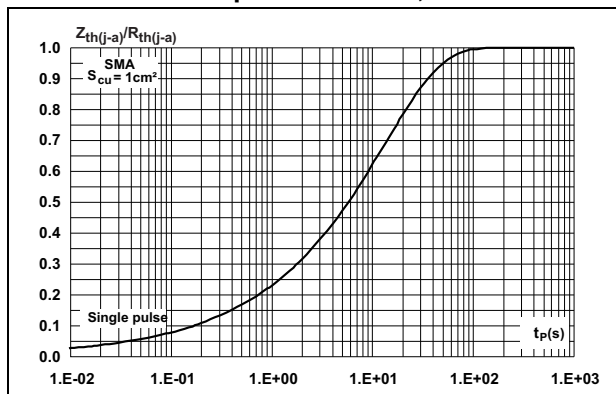

Figure 4. Relative variation of thermal impedance junction to ambient versus pulse duration, SMB

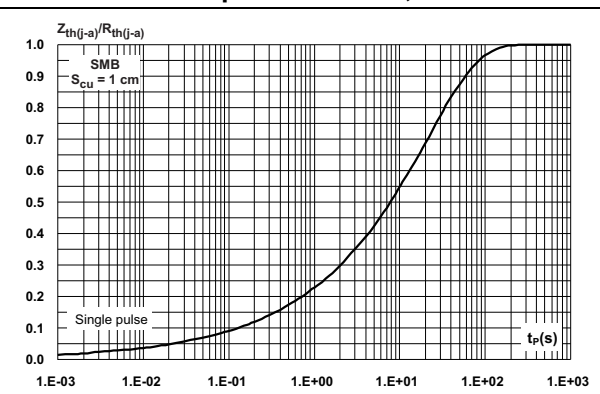

Figure 5. Junction capacitance versus reverse voltage applied (typical values)

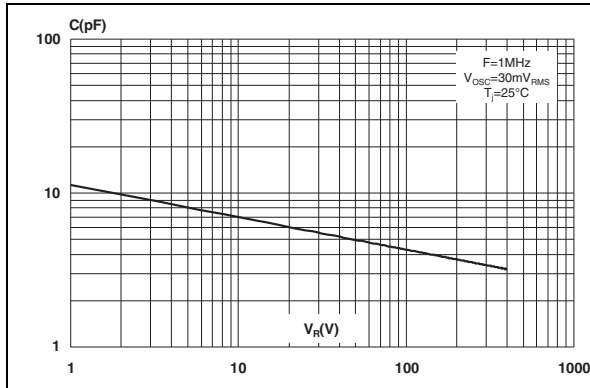

Figure 6. Reverse recovery charges versus dI_F/dt (typical values)

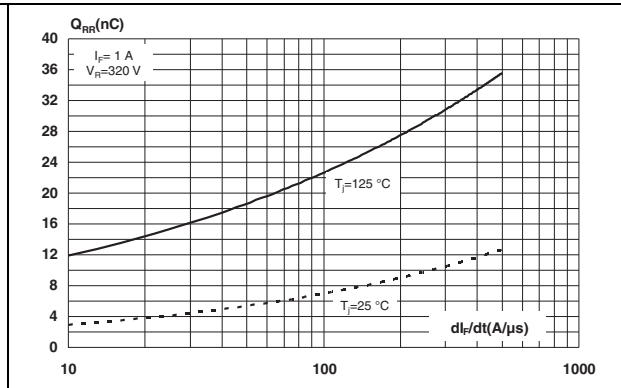

Figure 7. Reverse recovery time versus dI_F/dt (typical values)

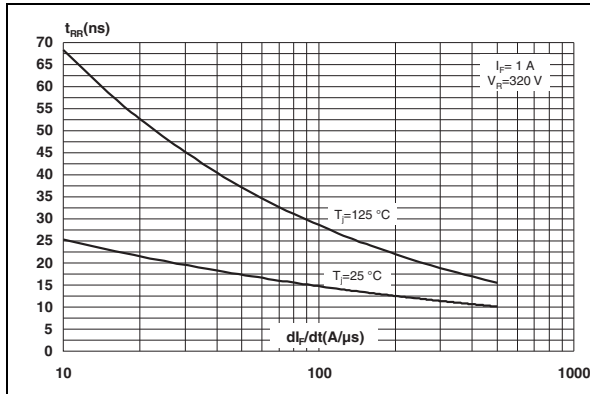

Figure 8. Peak reverse recovery current versus dI_F/dt (typical values)

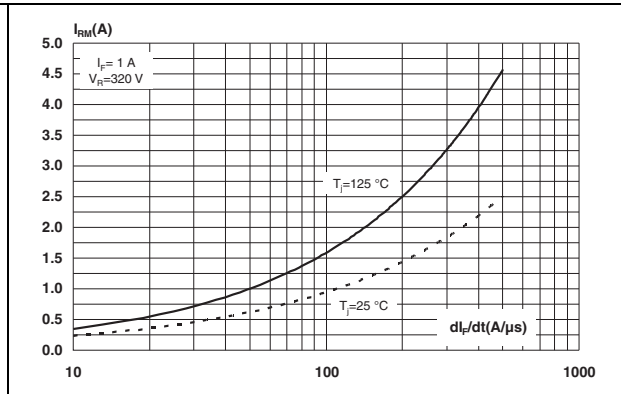

Figure 9. Relative variations of dynamic parameters versus junction temperature

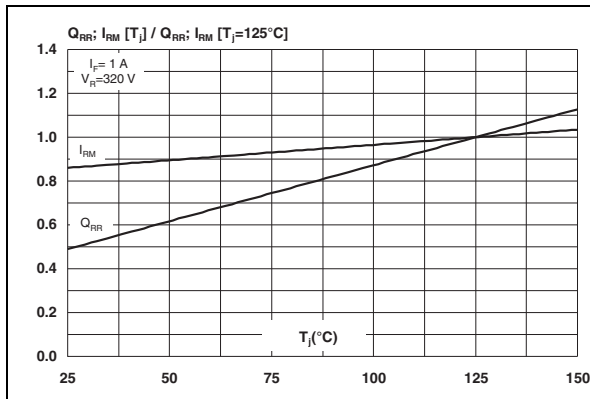

Figure 10. Transient peak forward voltage versus dI_F/dt (typical values)

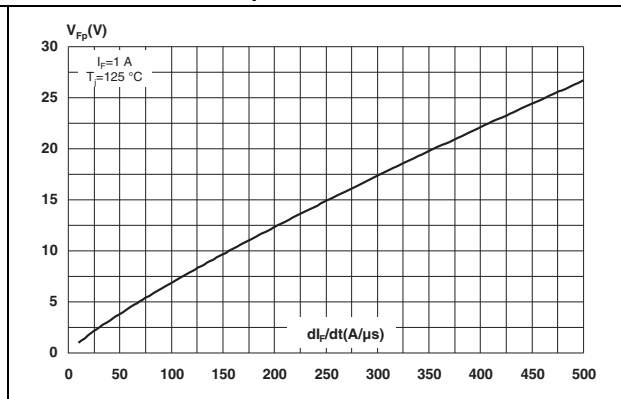

Figure 11. Forward recovery time versus di_F/dt (typical values)

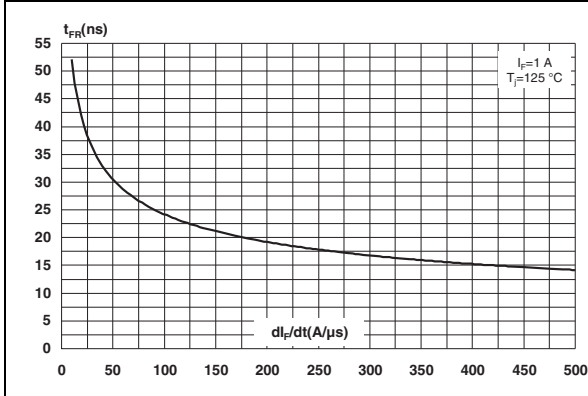

Figure 12. Thermal resistance junction to ambient versus copper surface under each lead

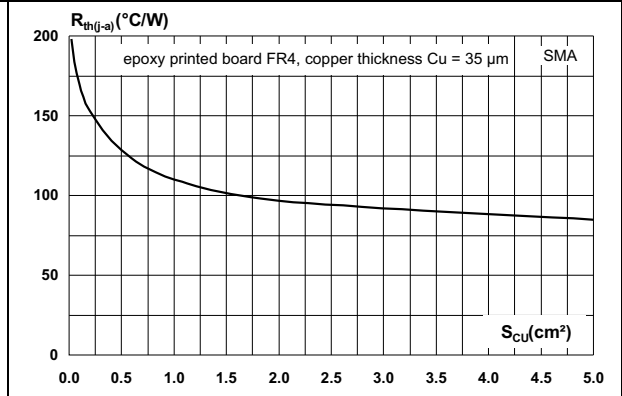
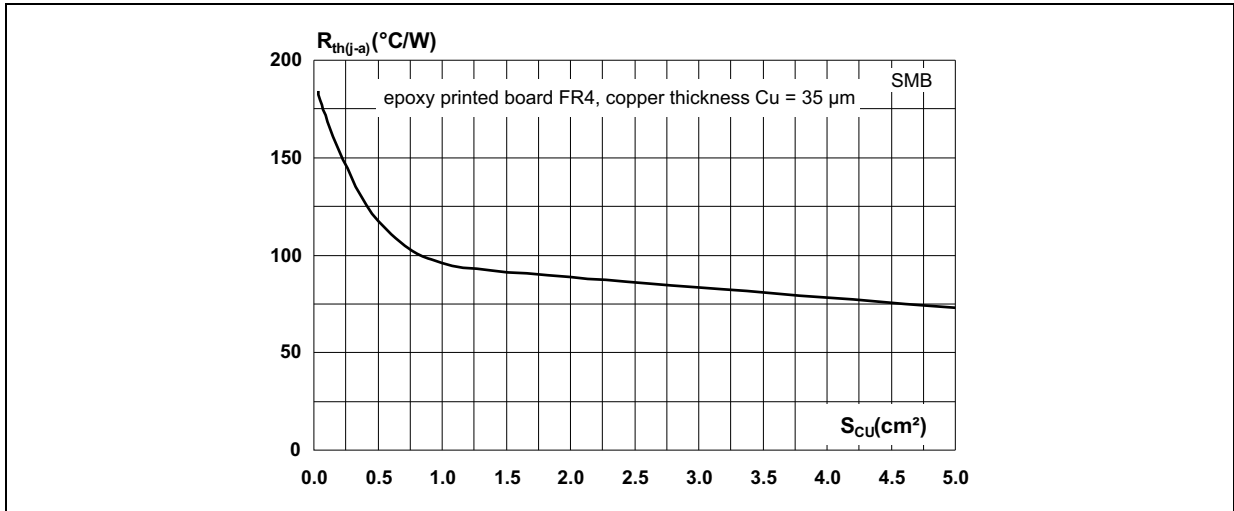

Figure 13. Thermal resistance junction to ambient versus copper surface under each lead



2 Package information

- Epoxy meets UL94, V0
- Lead-free package
- Cooling method: by conduction (C)

In order to meet environmental requirements, ST offers these devices in different grades of ECOPACK[®] packages, depending on their level of environmental compliance. ECOPACK[®] specifications, grade definitions and product status are available at: www.st.com. ECOPACK[®] is an ST trademark.

Figure 14. SMB dimension definitions

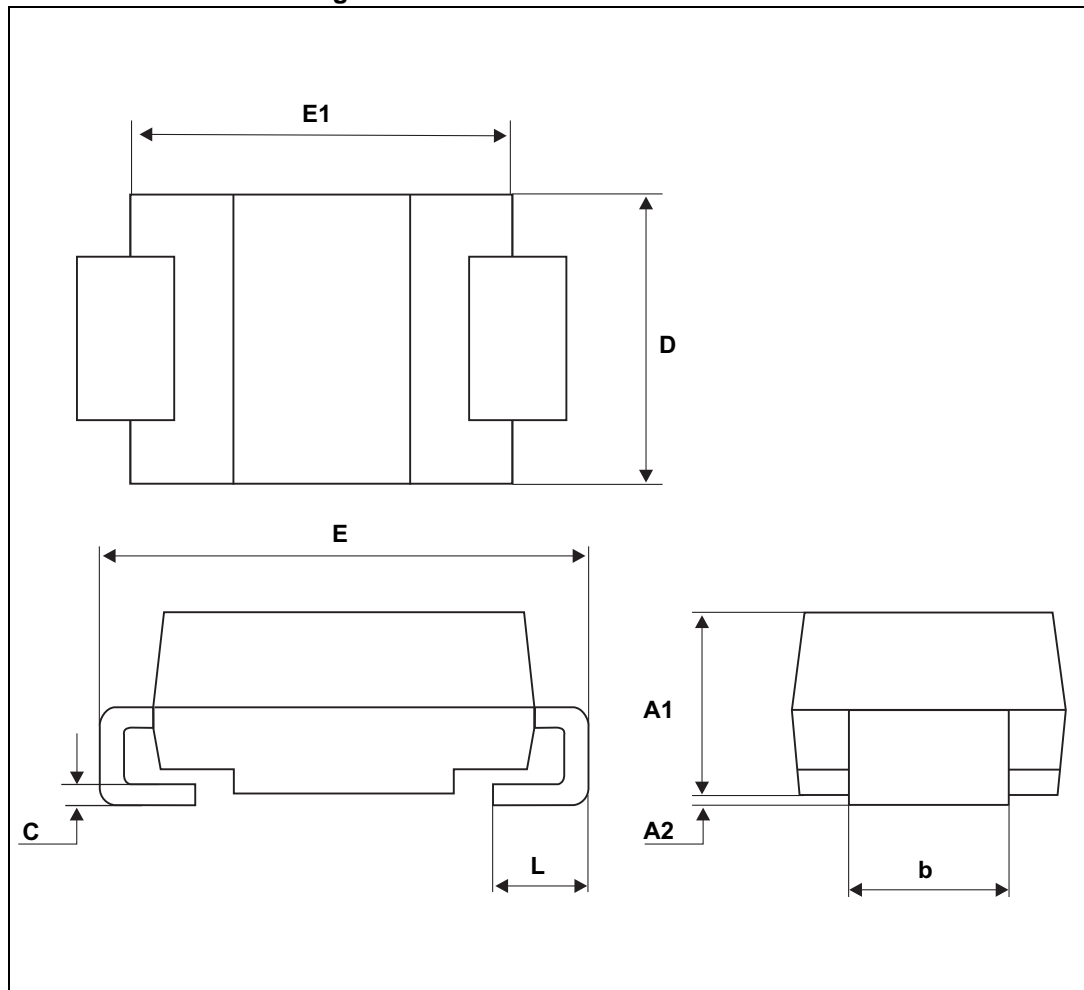

Table 6. SMB dimension values

Ref.	Dimensions					
	Millimeters			Inches		
	Min.	Typ.	Max.	Min.	Typ.	Max.
A1	1.90		2.45	0.075		0.096
A2	0.05		0.20	0.002		0.008
b	1.95		2.20	0.077		0.087
c	0.15		0.40	0.006		0.016
D	3.30		3.95	0.130		0.156
E	5.10		5.60	0.201		0.220
E1	4.05		4.60	0.159		0.181
L	0.75		1.50	0.030		0.059

Figure 15. SMB footprint, dimensions in mm (inches)

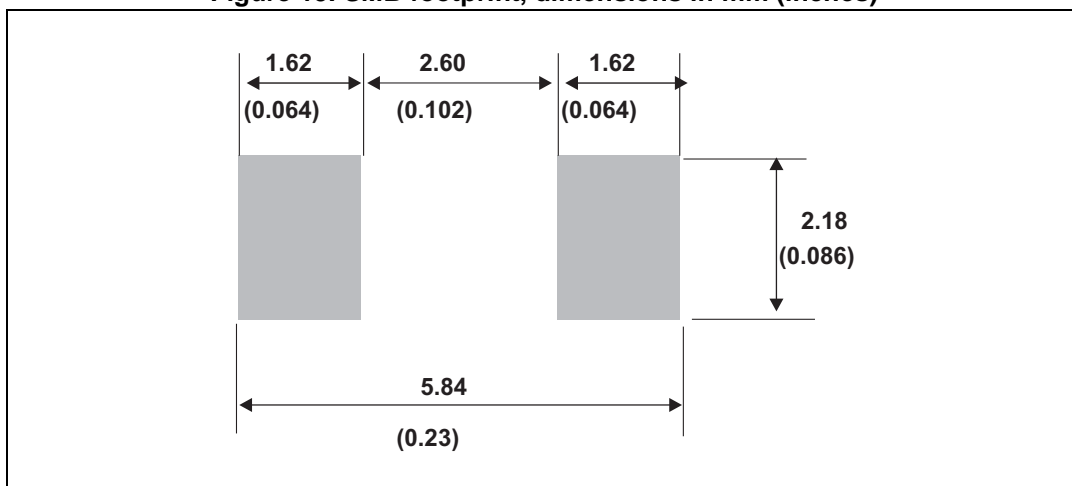

Figure 16. SMA dimension definitions

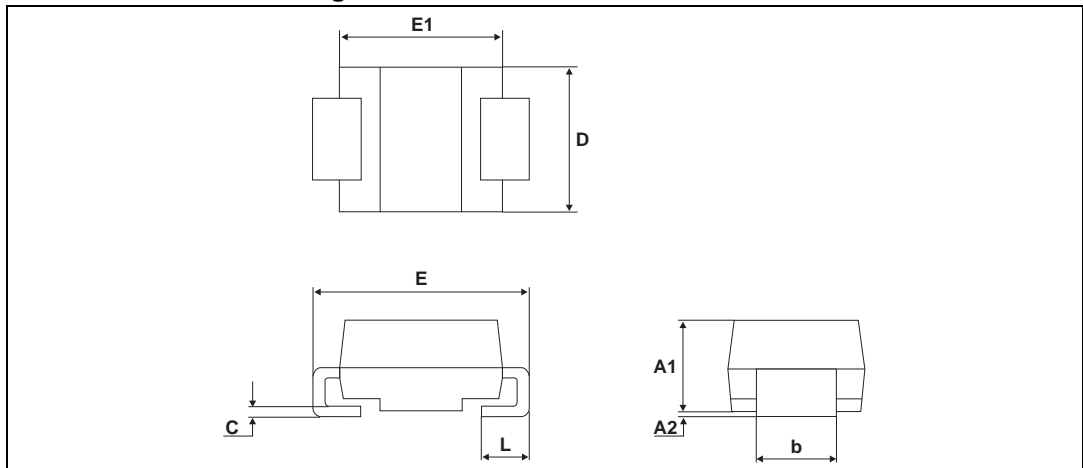
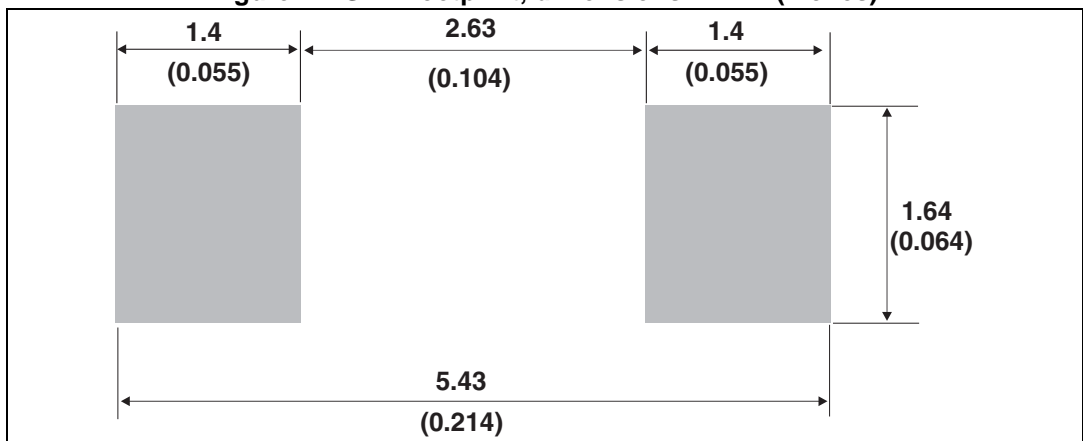

Table 7. SMA dimension values

Ref.	Dimensions					
	Millimeters			Inches		
	Min.	Typ.	Max.	Min.	Typ.	Max.
A1	1.90		2.45	0.075		0.094
A2	0.05		0.20	0.002		0.008
b	1.25		1.65	0.049		0.065
c	0.15		0.40	0.006		0.016
D	2.25		2.90	0.089		0.114
E	4.80		5.35	0.189		0.211
E1	3.95		4.60	0.156		0.181
L	0.75		1.50	0.030		0.059

Figure 17. SMA footprint, dimensions in mm (inches)



3 Ordering information

Table 8. Ordering information

Order code	Marking	Package	Weight	Base qty	Delivery mode
STTH1R04AY	HR4Y	SMA	0.068 g	5000	Tape and reel
STTH1R04UY	BR4Y	SMB	0.12 g	2500	Tape and reel

4 Revision history

Table 9. Document revision history

Date	Revision	Description of changes
09-Jul-2013	1	First issue

Please Read Carefully:

Information in this document is provided solely in connection with ST products. STMicroelectronics NV and its subsidiaries ("ST") reserve the right to make changes, corrections, modifications or improvements, to this document, and the products and services described herein at any time, without notice.

All ST products are sold pursuant to ST's terms and conditions of sale.

Purchasers are solely responsible for the choice, selection and use of the ST products and services described herein, and ST assumes no liability whatsoever relating to the choice, selection or use of the ST products and services described herein.

No license, express or implied, by estoppel or otherwise, to any intellectual property rights is granted under this document. If any part of this document refers to any third party products or services it shall not be deemed a license grant by ST for the use of such third party products or services, or any intellectual property contained therein or considered as a warranty covering the use in any manner whatsoever of such third party products or services or any intellectual property contained therein.

UNLESS OTHERWISE SET FORTH IN ST'S TERMS AND CONDITIONS OF SALE ST DISCLAIMS ANY EXPRESS OR IMPLIED WARRANTY WITH RESPECT TO THE USE AND/OR SALE OF ST PRODUCTS INCLUDING WITHOUT LIMITATION IMPLIED WARRANTIES OF MERCHANTABILITY, FITNESS FOR A PARTICULAR PURPOSE (AND THEIR EQUIVALENTS UNDER THE LAWS OF ANY JURISDICTION), OR INFRINGEMENT OF ANY PATENT, COPYRIGHT OR OTHER INTELLECTUAL PROPERTY RIGHT.

ST PRODUCTS ARE NOT AUTHORIZED FOR USE IN WEAPONS. NOR ARE ST PRODUCTS DESIGNED OR AUTHORIZED FOR USE IN: (A) SAFETY CRITICAL APPLICATIONS SUCH AS LIFE SUPPORTING, ACTIVE IMPLANTED DEVICES OR SYSTEMS WITH PRODUCT FUNCTIONAL SAFETY REQUIREMENTS; (B) AERONAUTIC APPLICATIONS; (C) AUTOMOTIVE APPLICATIONS OR ENVIRONMENTS, AND/OR (D) AEROSPACE APPLICATIONS OR ENVIRONMENTS. WHERE ST PRODUCTS ARE NOT DESIGNED FOR SUCH USE, THE PURCHASER SHALL USE PRODUCTS AT PURCHASER'S SOLE RISK, EVEN IF ST HAS BEEN INFORMED IN WRITING OF SUCH USAGE, UNLESS A PRODUCT IS EXPRESSLY DESIGNATED BY ST AS BEING INTENDED FOR "AUTOMOTIVE, AUTOMOTIVE SAFETY OR MEDICAL" INDUSTRY DOMAINS ACCORDING TO ST PRODUCT DESIGN SPECIFICATIONS. PRODUCTS FORMALLY ESCC, QML OR JAN QUALIFIED ARE DEEMED SUITABLE FOR USE IN AEROSPACE BY THE CORRESPONDING GOVERNMENTAL AGENCY.

Resale of ST products with provisions different from the statements and/or technical features set forth in this document shall immediately void any warranty granted by ST for the ST product or service described herein and shall not create or extend in any manner whatsoever, any liability of ST.

ST and the ST logo are trademarks or registered trademarks of ST in various countries.

Information in this document supersedes and replaces all information previously supplied.

The ST logo is a registered trademark of STMicroelectronics. All other names are the property of their respective owners.

© 2013 STMicroelectronics - All rights reserved

STMicroelectronics group of companies

Australia - Belgium - Brazil - Canada - China - Czech Republic - Finland - France - Germany - Hong Kong - India - Israel - Italy - Japan - Malaysia - Malta - Morocco - Philippines - Singapore - Spain - Sweden - Switzerland - United Kingdom - United States of America

www.st.com