

**600mA LOW DROPOUT LINEAR REGULATOR****AP2317****General Description**

The AP2317 is a series of low dropout three-terminal regulators with a dropout of 1.1V at 600mA output current.

This product has been optimized for low voltage where transient response and minimum input voltage are critical. The AP2317 provides current limit and thermal shutdown. Its circuit includes a trimmed bandgap reference to assure output voltage accuracy to be within $\pm 1\%$. On-chip thermal shutdown provides protection against any combination of overload and ambient temperatures that would create excessive junction temperatures.

The AP2317 is available in 2.5V and 3.3V versions. The fixed versions integrate the corresponding resistor divider. It is also available in an adjustable version which can set the output voltage with two external resistors.

The AP2317 is available in the industry standard SOT-89-3, SOT-223 and TO-263-3 (for 3.3V only) power packages.

Features

- Low Dropout Voltage: 1.1V at 600mA Output Current
- Output Noise from 10Hz to 10KHz: 0.003% of V_{OUT}
- PSRR at $I_{OUT}=300mA$ and $f=120Hz$: 75dB
- Output Voltage Accuracy: $\pm 1\%$
- On-chip Thermal Shutdown
- Maximum Quiescent Current: $I_{QMAX}=5mA$
- ESD (Human Body Model): 3.5KV
- Operation Junction Temperature: -40 to $125^{\circ}C$

Applications

- DVD/CD-ROM
- USB Device
- Add-on Card
- DVD Player
- PC Motherboard

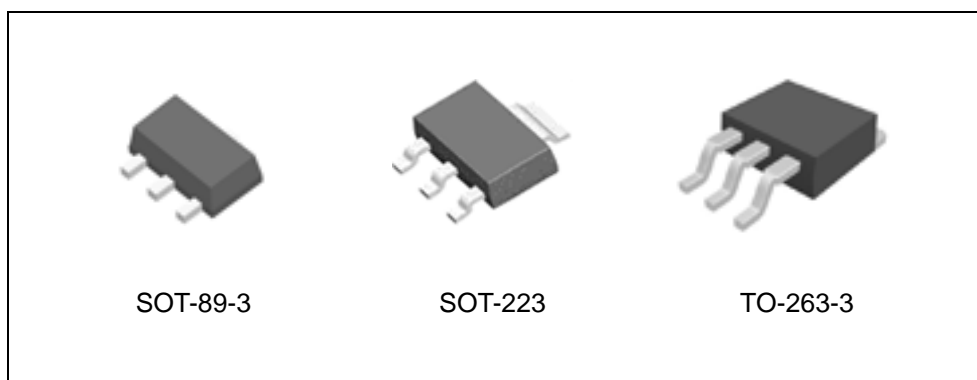

Figure 1. Package Types of AP2317



600mA LOW DROPOUT LINEAR REGULATOR

AP2317

Pin Configuration

H Package
(SOT-223)

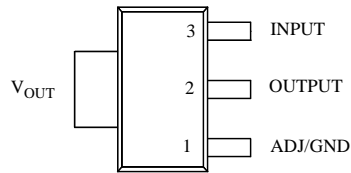

R Package
(SOT-89-3)

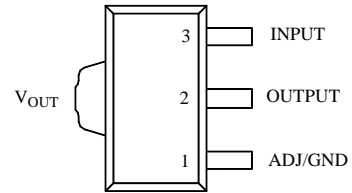

S Package
(TO-263-3)

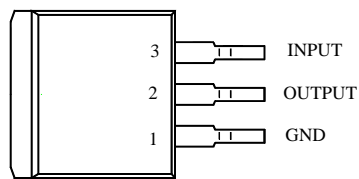

Figure 2. Pin Configuration of AP2317 (Top View)



600mA LOW DROPOUT LINEAR REGULATOR

AP2317

Functional Block Diagram

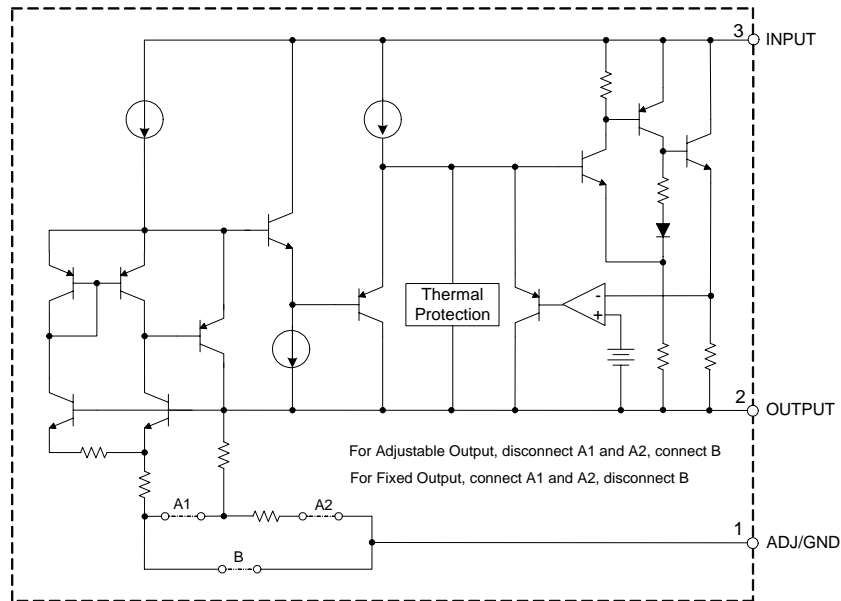

Figure 3. Functional Block Diagram of AP2317



600mA LOW DROPOUT LINEAR REGULATOR

AP2317

Ordering Information

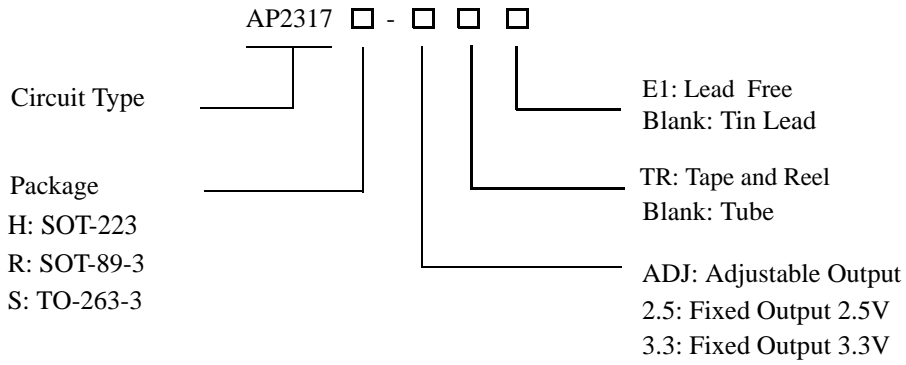

Package	Temperature Range	Part Number		Marking ID		Packing Type
		Tin Lead	Lead Free	Tin Lead	Lead Free	
SOT-89-3	-40 to 125°C	AP2317R-ADJTR	AP2317R-ADJTRE1	R27A	E27A	Tape & Reel
		AP2317R-2.5TR	AP2317R-2.5TRE1	R27B	E27B	Tape & Reel
		AP2317R-3.3TR	AP2317R-3.3TRE1	R27C	E27C	Tape & Reel
SOT-223	-40 to 125°C	AP2317H-ADJTR	AP2317H-ADJTRE1	H27A	EH27A	Tape & Reel
		AP2317H-2.5TR	AP2317H-2.5TRE1	H27B	EH27B	Tape & Reel
		AP2317H-3.3TR	AP2317H-3.3TRE1	H27C	EH27C	Tape & Reel
TO-263-3	-40 to 125°C	AP2317S-3.3	AP2317S-3.3E1	AP2317S-3.3	AP2317S-3.3E1	Tube
		AP2317S-3.3TR	AP2317S-3.3TRE1	AP2317S-3.3	AP2317S-3.3E1	Tape & Reel

BCD Semiconductor's Pb-free products, as designated with "E1" suffix in the part number, are RoHS compliant.

**600mA LOW DROPOUT LINEAR REGULATOR****AP2317****Absolute Maximum Ratings (Note 1)**

Parameter	Symbol	Value	Unit
Input Voltage	V_{IN}	15	V
Operating Junction Temperature	T_J	150	°C
Storage Temperature Range	T_{STG}	-65 to 150	°C
Lead Temperature (Soldering, 10sec)	T_{LEAD}	260	°C
Thermal Resistance (Note 2)	θ_{JA}	SOT-223	120
		SOT-89-3	165
		TO-263-3	80
ESD (Human Body Model)	ESD	3500	V
ESD (Machine Model)	ESD	400	V

Note 1: Stresses greater than those listed under "Absolute Maximum Ratings" may cause permanent damage to the device. These are stress ratings only, and functional operation of the device at these or any other conditions beyond those indicated under "Recommended Operating Conditions" is not implied. Exposure to "Absolute Maximum Ratings" for extended periods may affect device reliability.

Note 2: Absolute maximum ratings indicate limits beyond which damage to the component may occur. Electrical specifications do not apply when operating the device outside of its operating ratings. The maximum allowable power dissipation is a function of the maximum junction temperature, $T_{J(max)}$, the junction-to-ambient thermal resistance, θ_{JA} , and the ambient temperature, T_A . The maximum allowable power dissipation at any ambient temperature is calculated using: $P_{D(max)} = (T_{J(max)} - T_A) / \theta_{JA}$. Exceeding the maximum allowable power dissipation will result in excessive die temperature, and the regulator will go into thermal shutdown.

Recommended Operating Conditions

Parameter	Symbol	Min	Max	Unit
Input Voltage	V_{IN}		12	V
Operating Junction Temperature Range	T_J	-40	125	°C



600mA LOW DROPOUT LINEAR REGULATOR

AP2317

Electrical Characteristics

Operating Conditions: $V_{IN} \leq 10V$, $T_J = 25^\circ C$, unless otherwise specified. ($P \leq$ maximum power dissipation)

Limits appearing in **Boldface** type apply over the entire junction temperature range for operation, $-40^\circ C$ to $125^\circ C$

Parameter	Symbol	Conditions	Min	Typ	Max	Unit
Reference Voltage	V_{REF}	AP2317-ADJ $I_{OUT} = 10mA$, $V_{IN} - V_{OUT} = 2V$, $T_J = 25^\circ C$ $10mA \leq I_{OUT} \leq 600mA$, $1.4V \leq V_{IN} - V_{OUT} \leq 8V$ $P \leq$ maximum power dissipation	1.238 1.225	1.250 1.250	1.262 1.270	V
Output Voltage	V_{OUT}	AP2317-2.5 $I_{OUT} = 10mA$, $V_{IN} = 4.5V$, $T_J = 25^\circ C$ $10mA \leq I_{OUT} \leq 600mA$, $3.9V \leq V_{IN} \leq 10V$	2.475 2.450	2.5 2.5	2.525 2.550	V
		AP2317-3.3 $I_{OUT} = 10mA$, $V_{IN} = 5.0V$, $T_J = 25^\circ C$ $10mA \leq I_{OUT} \leq 600mA$, $4.75V \leq V_{IN} \leq 10V$	3.267 3.235	3.3 3.3	3.333 3.365	V
Line Regulation	ΔV_{OUT}	AP2317-ADJ $I_{OUT} = 10mA$, $1.5V \leq V_{IN} - V_{OUT} \leq 10V$		0.035	0.2	%
		AP2317-2.5 $I_{OUT} = 10mA$, $1.5V \leq V_{IN} - V_{OUT} \leq 10V$		1	6	mV
		AP2317-3.3 $I_{OUT} = 10mA$, $1.5V \leq V_{IN} - V_{OUT} \leq 10V$		1	6	mV
Load Regulation	ΔV_{OUT}	AP2317-ADJ $(V_{IN} - V_{OUT}) = 2V$, $10mA \leq I_{OUT} \leq 600mA$		0.2	0.4	%
		AP2317-2.5 $(V_{IN} - V_{OUT}) = 2V$, $10mA \leq I_{OUT} \leq 600mA$		1	10	mV
		AP2317-3.3 $(V_{IN} - V_{OUT}) = 2V$, $10mA \leq I_{OUT} \leq 600mA$		1	10	mV
Dropout Voltage	V_{DROP}	$\Delta V_{REF} = 1\%$, $I_{OUT} = 0.6A$		1.1	1.3	V
Current Limit	I_{LIMIT}	$(V_{IN} - V_{OUT}) = 2V$	0.75	0.9		A
Adjust Pin Current	I_{ADJ}			60	120	μA
Adjust Pin Current Change	ΔI_{ADJ}	$1.4V \leq (V_{IN} - V_{OUT}) \leq 10$, $10mA \leq I_{OUT} \leq 600mA$		0.2	5	μA
Minimum Load Current	$I_{LOAD (MIN)}$	$1.5V \leq (V_{IN} - V_{OUT}) \leq 10V$ (ADJ only)		1.7	5	mA
Quiescent Current	I_Q	$V_{IN} = V_{OUT} + 1.25V$			5	mA
Ripple Rejection	PSRR	$f = 120Hz$, $C_{OUT} = 22\mu F$ Tantalum $(V_{IN} - V_{OUT}) = 3V$, $I_{OUT} = 300mA$	60	75		dB
Temperature Stability				0.5		%
Long-Term Stability		$T_A = 125^\circ C$, 1000hrs.		0.3		%
RMS Output Noise (% of V_{OUT})		$T_A = 25^\circ C$, $10Hz \leq f \leq 10KHz$		0.003		%
Thermal Shutdown		Junction Temperature		150		$^\circ C$
Thermal Shutdown Hysteresis				25		$^\circ C$



600mA LOW DROPOUT LINEAR REGULATOR

AP2317

Typical Performance Characteristics

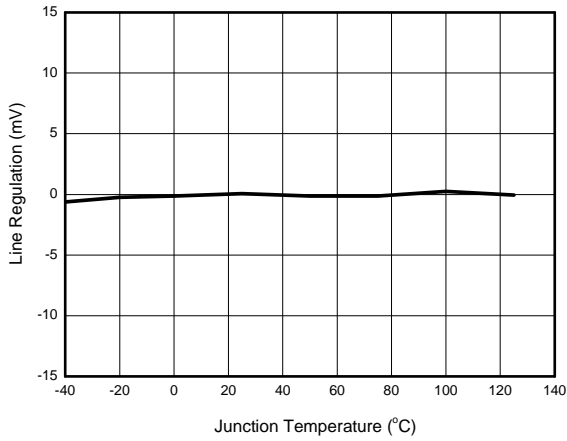

Figure 4. Line Regulation vs. Junction Temperature

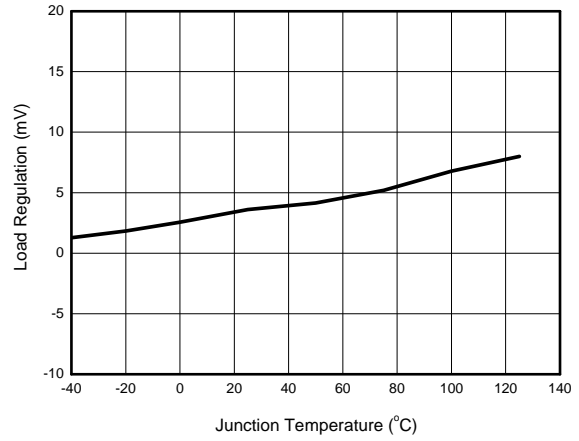

Figure 5. Load Regulation vs. Junction Temperature

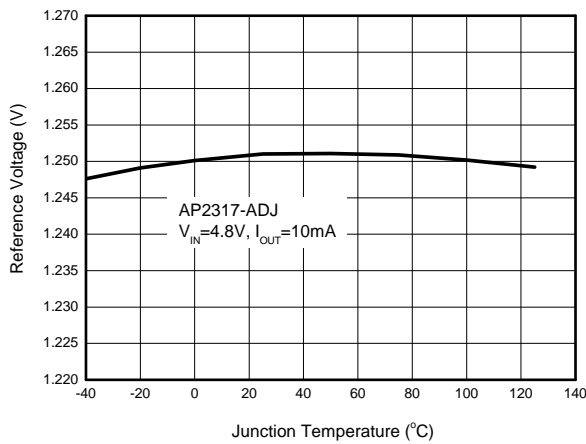

Figure 6. Reference Voltage vs. Junction Temperature

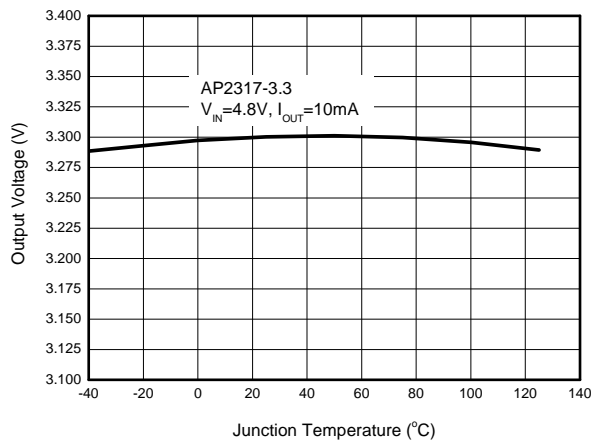

Figure 7. Output Voltage vs. Junction Temperature



600mA LOW DROPOUT LINEAR REGULATOR

AP2317

Typical Performance Characteristics (Continued)

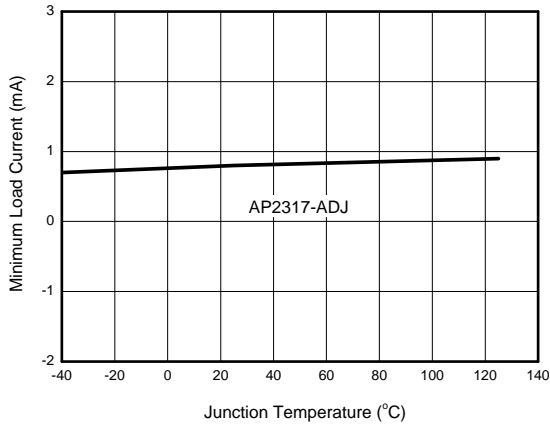

Figure 8. Minimum Load Current vs. Junction Temperature

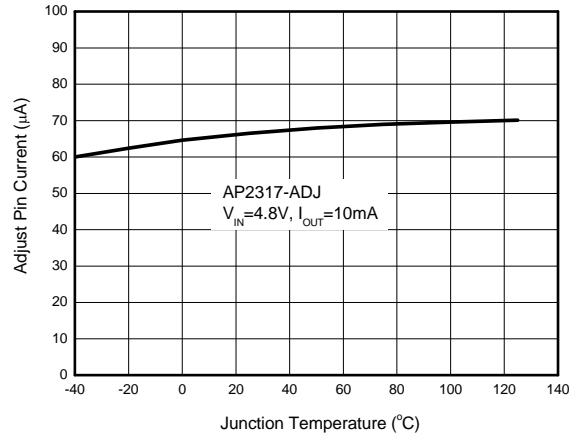

Figure 9. Adjust Pin Current vs. Junction Temperature

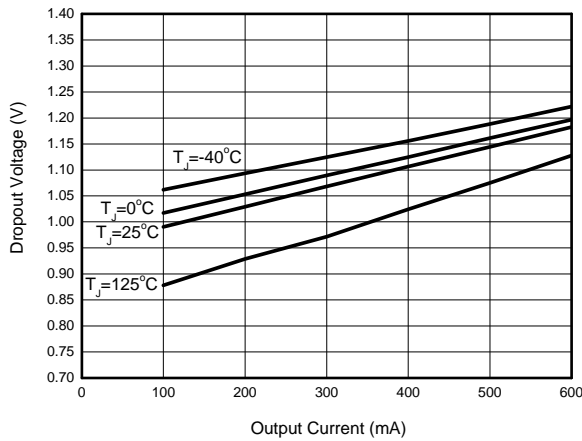

Figure 10. Dropout Voltage vs. Output Current

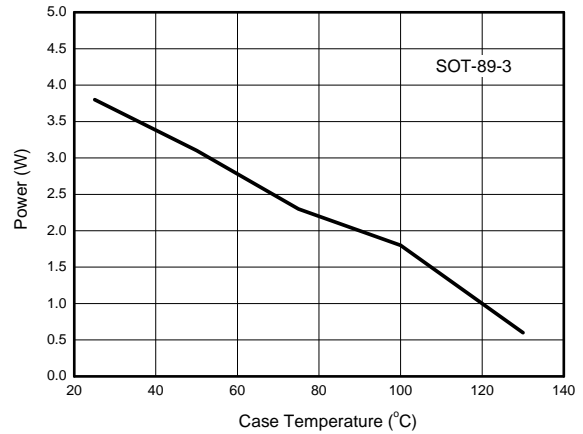

Figure 11. Maximum Power Dissipation



600mA LOW DROPOUT LINEAR REGULATOR

AP2317

Typical Performance Characteristics (Continued)

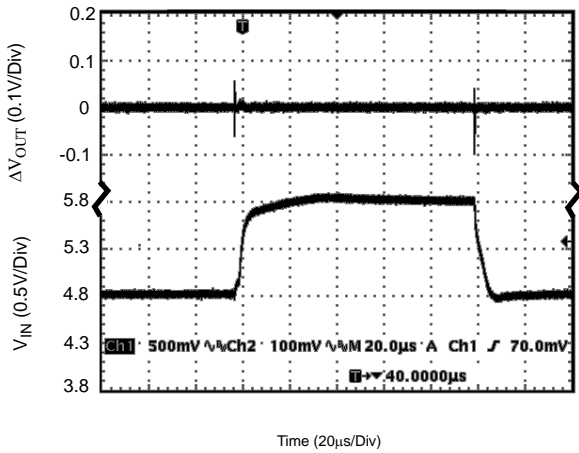

Figure 12. Line Transient Response
(Conditions: $V_{IN}=4.8$ to $5.8V$, $V_{OUT}=3.33V$, $I_{OUT}=0.1A$,
 $C_{IN}=1\mu F$, $C_{OUT}=10\mu F$)

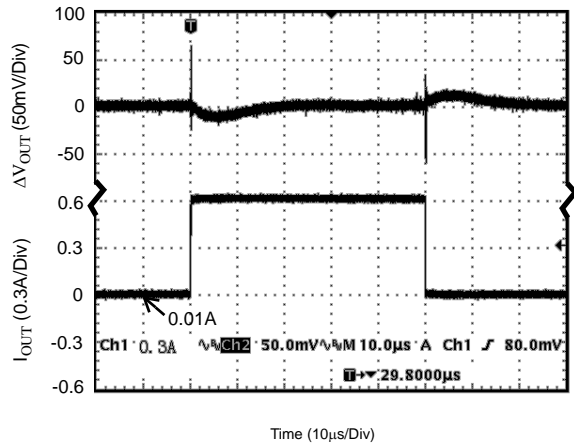

Figure 13. Load Transient Response
(Conditions: $V_{IN}=4.8V$, $V_{OUT}=3.33V$, $I_{OUT}=0.01$ to $0.6A$,
 $C_{IN}=C_{OUT}=10\mu F$)

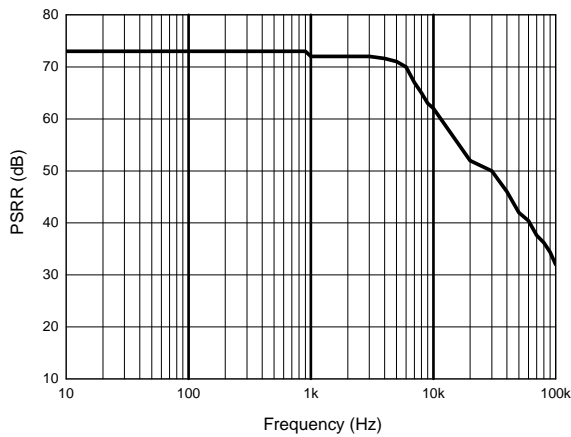

Figure 14. PSRR vs. Frequency

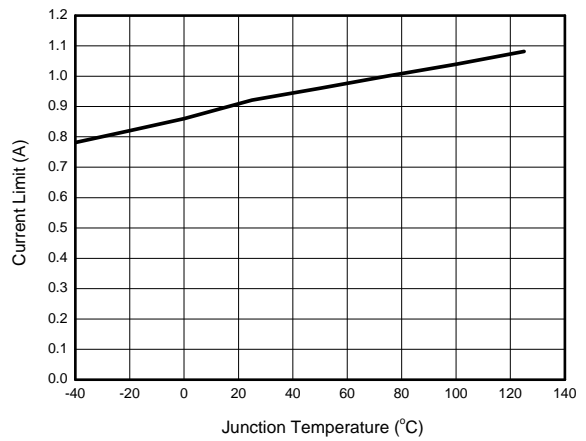

Figure 15. Current Limit vs. Junction Temperature



600mA LOW DROPOUT LINEAR REGULATOR

AP2317

Typical Applications

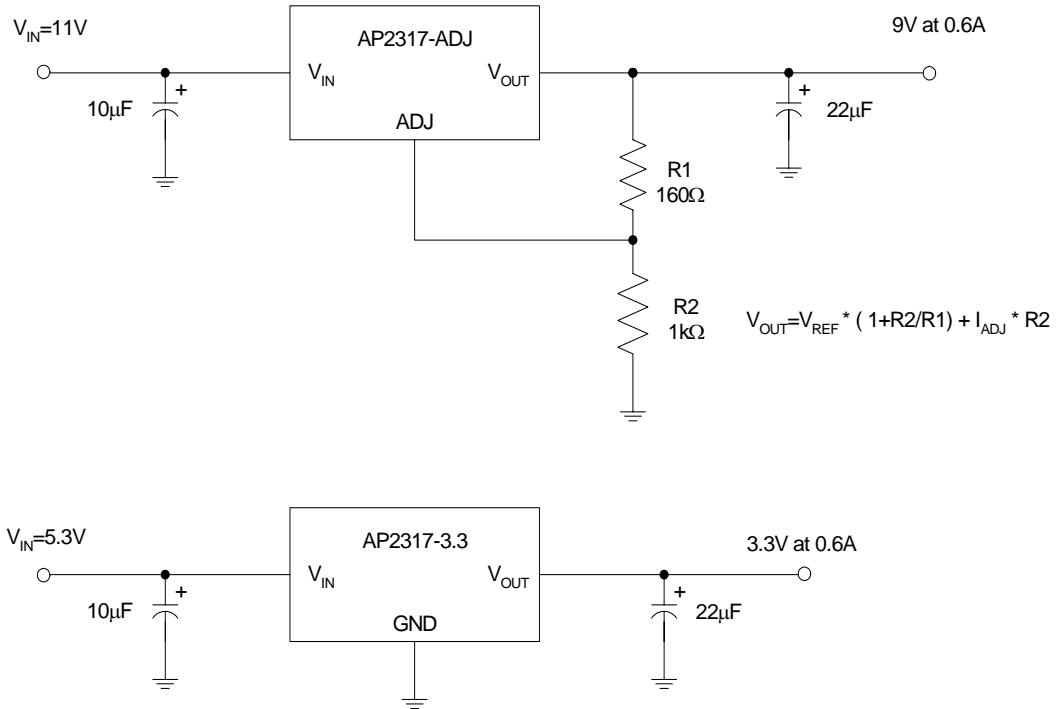

Figure 16. Typical Applications of AP2317



600mA LOW DROPOUT LINEAR REGULATOR

AP2317

Mechanical Dimensions

SOT-89-3

Unit: mm(inch)

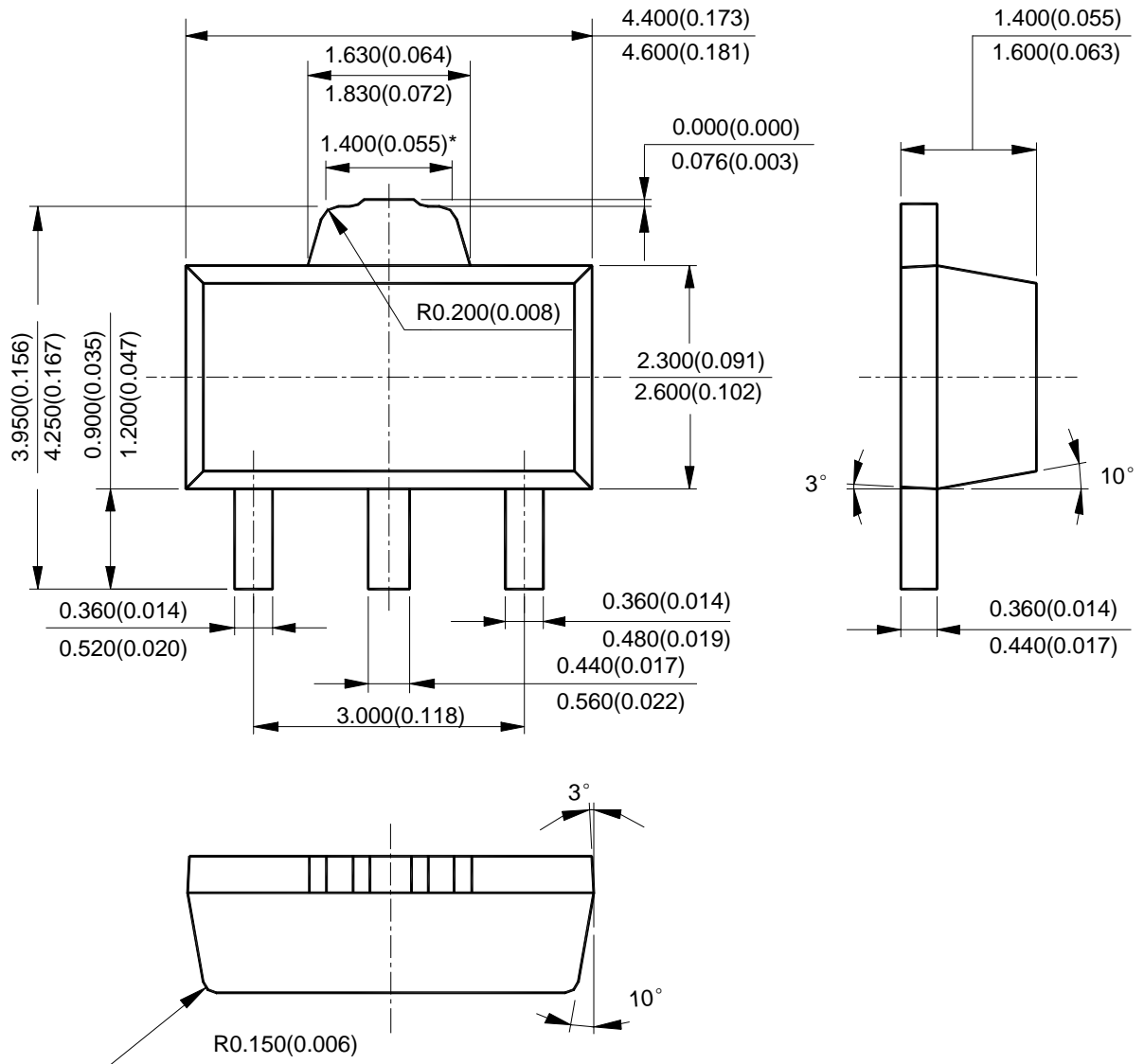



600mA LOW DROPOUT LINEAR REGULATOR

AP2317

Mechanical Dimensions (Continued)

SOT-223

Unit: mm(inch)

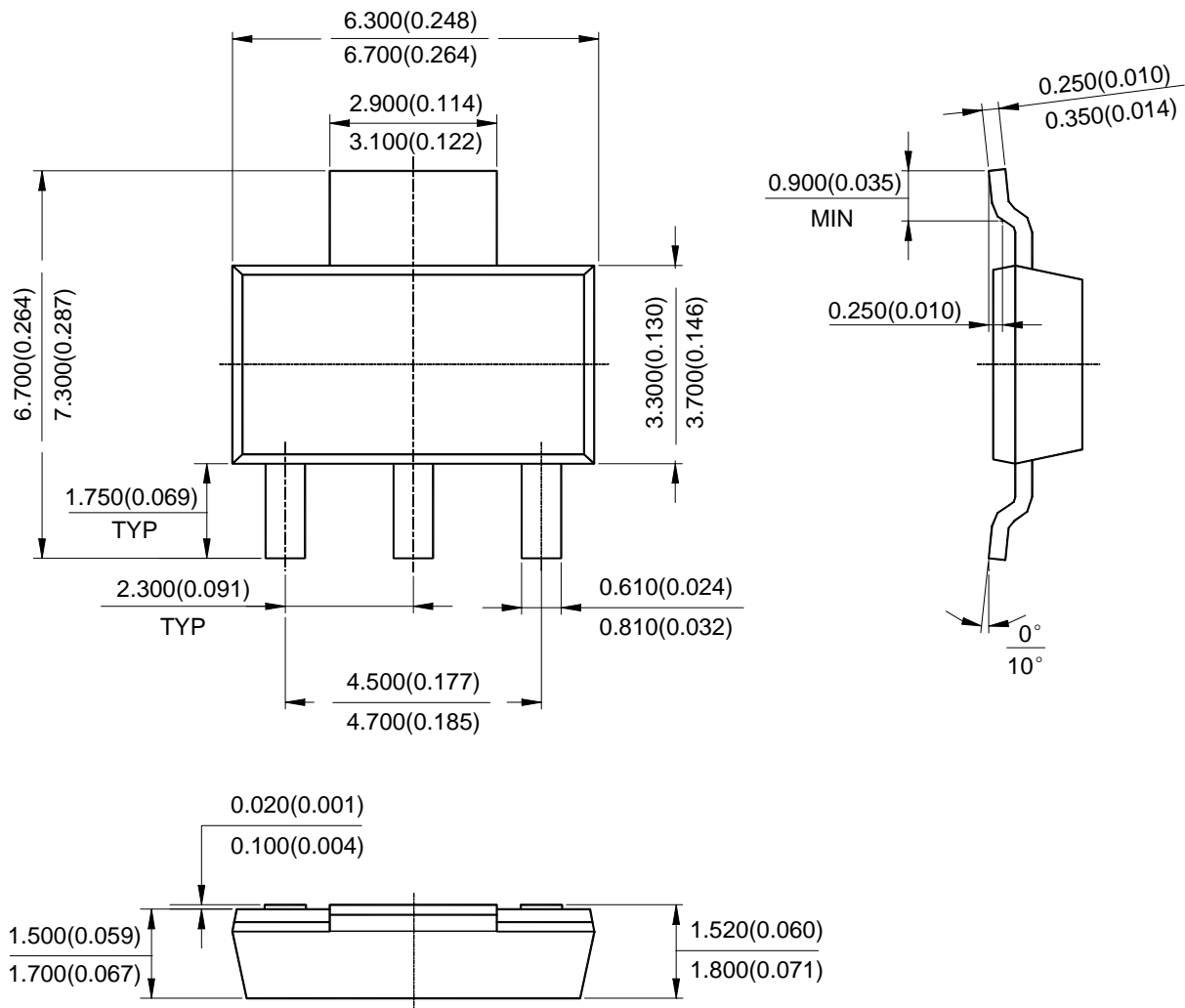



600mA LOW DROPOUT LINEAR REGULATOR

AP2317

Mechanical Dimensions (Continued)

TO-263-3

Unit: mm(inch)

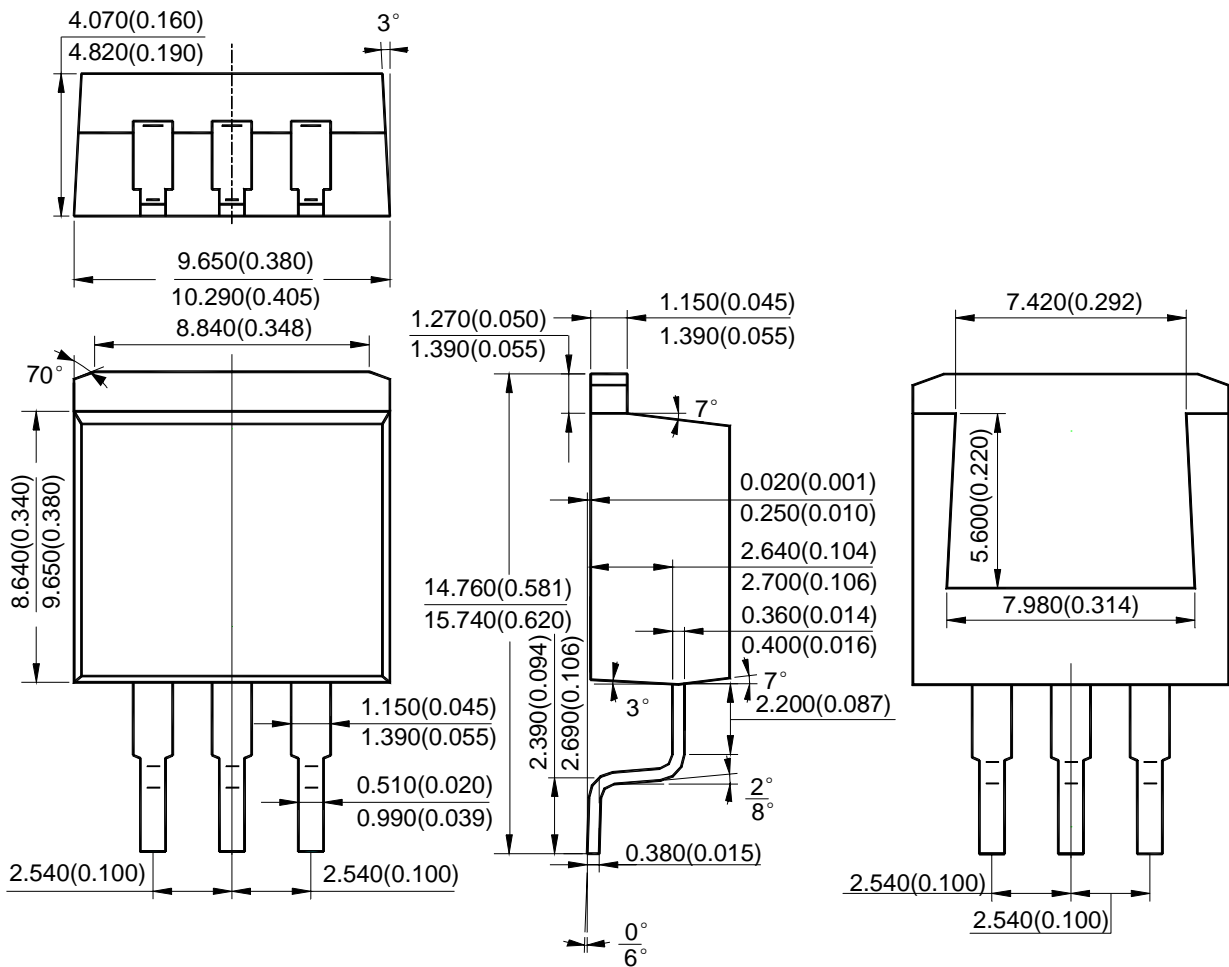



BCD Semiconductor Manufacturing Limited

<http://www.bcdsemi.com>

IMPORTANT NOTICE

BCD Semiconductor Manufacturing Limited reserves the right to make changes without further notice to any products or specifications herein. BCD Semiconductor Manufacturing Limited does not assume any responsibility for use of any its products for any particular purpose, nor does BCD Semiconductor Manufacturing Limited assume any liability arising out of the application or use of any its products or circuits. BCD Semiconductor Manufacturing Limited does not convey any license under its patent rights or other rights nor the rights of others.

MAIN SITE

BCD Semiconductor Manufacturing Limited
- Wafer Fab
Shanghai SIM-BCD Semiconductor Manufacturing Limited
800, Yi Shan Road, Shanghai 200233, China
Tel: +86-21-6485 1491, Fax: +86-21-5450 0008

BCD Semiconductor Manufacturing Limited
- IC Design Group
Advanced Analog Circuits (Shanghai) Corporation
8F, Zone B, 900, Yi Shan Road, Shanghai 200233, China
Tel: +86-21-6495 9539, Fax: +86-21-6485 9673

REGIONAL SALES OFFICE

Shenzhen Office
Shanghai SIM-BCD Semiconductor Manufacturing Co., Ltd. Shenzhen Office
Advanced Analog Circuits (Shanghai) Corporation Shenzhen Office
Room E, 5F, Noble Center, No.1006, 3rd Fuzhong Road, Futian District, Shenzhen 518026, China
Tel: +86-755-8826 7951
Fax: +86-755-8826 7865

Taiwan Office
BCD Semiconductor (Taiwan) Company Limited
4F, 298-1, Rui Guang Road, Nei-Hu District, Taipei,
Taiwan
Tel: +886-2-2656 2808
Fax: +886-2-2656 2806

USA Office
BCD Semiconductor Corporation
30920 Huntwood Ave. Hayward,
CA 94544, U.S.A
Tel : +1-510-324-2988
Fax: +1-510-324-2788