

N-Channel 20-V (D-S) MOSFET

PRODUCT SUMMARY				
V _{DS} (V)	R _{DS(on)} (Ω) ^e	I _D (A) ^a		Q _g (Typ.)
		Silicon Limit	Package Limit	
20	0.0016 at V _{GS} = 10 V	220	60	46 nC
	0.0025 at V _{GS} = 4.5 V	117	60	

Package Drawing

www.vishay.com/doc?72945

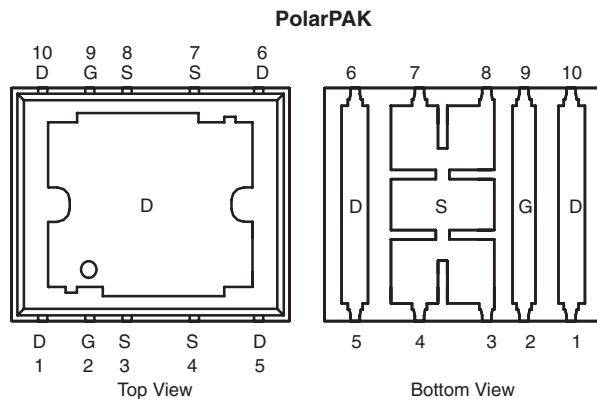

Top surface is connected to pins 1, 5, 6, and 10

Ordering Information: SiE808DF-T1-E3 (Lead (Pb)-free)
SiE808DF-T1-GE3 (Lead (Pb)-free and Halogen-free)

FEATURES

- Halogen-free According to IEC 61249-2-21 Definition
- TrenchFET[®] Gen II Power MOSFET
- Ultra Low Thermal Resistance Using Top-Exposed PolarPAK[®] Package for Double-Sided Cooling
- Leadframe-Based New Encapsulated Package
 - Die Not Exposed
 - Same Layout Regardless of Die Size
- Low Q_{gd}/Q_{gs} Ratio Helps Prevent Shoot-Through
- 100 % R_g and UIS Tested
- Compliant to RoHS directive 2002/95/EC



RoHS
COMPLIANT
HALOGEN
FREE
Available

APPLICATIONS

- VRM
- DC/DC Conversion: Low-Side
- Synchronous Rectification

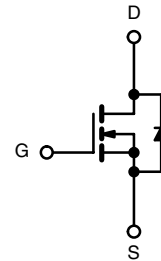

N-Channel MOSFET
For Related Documents
www.vishay.com/ppg?73739

ABSOLUTE MAXIMUM RATINGS T _A = 25 °C, unless otherwise noted				
Parameter	Symbol	Limit	Unit	
Drain-Source Voltage	V _{DS}	20	V	
Gate-Source Voltage	V _{GS}	± 20	V	
Continuous Drain Current (T _J = 150 °C)	I _D	220 (Silicon Limit)	A	
		60 ^a (Package Limit)		
		60 ^a		
		45 ^{b, c}		
Pulsed Drain Current	I _{DM}	100		
		60 ^a		
Continuous Source-Drain Diode Current	I _S	4.3 ^{b, c}		
		60 ^a		
Single Pulse Avalanche Current	I _{AS}	35		
Avalanche Energy	E _{AS}	61	mJ	
Maximum Power Dissipation	P _D	125	W	
		80		
		5.2 ^{b, c}		
		3.3 ^{b, c}		
Operating Junction and Storage Temperature Range	T _J , T _{stg}	- 55 to 150	°C	
Soldering Recommendations (Peak Temperature) ^{d, e}		260		

Notes:

- Package limited is 60 A.
- Surface Mounted on 1" x 1" FR4 board.
- t = 10 s.
- See Solder Profile (www.vishay.com/doc?73257). The PolarPAK is a leadless package. The end of the lead terminal is exposed copper (not plated) as a result of the singulation process in manufacturing. A solder fillet at the exposed copper tip cannot be guaranteed and is not required to ensure adequate bottom side solder interconnection.
- Rework Conditions: manual soldering with a soldering iron is not recommended for leadless components.

THERMAL RESISTANCE RATINGS

Parameter		Symbol	Typical	Maximum	Unit
Maximum Junction-to-Ambient ^{a, b}	$t \leq 10$ s	R_{thJA}	20	24	°C/W
Maximum Junction-to-Case (Drain Top)	Steady State	R_{thJC} (Drain)	0.8	1	
Maximum Junction-to-Case (Source) ^{a, c}		R_{thJC} (Source)	2.2	2.7	

Notes:

- a. Surface Mounted on 1" x 1" FR4 board.
b. Maximum under Steady State conditions is 68 °C/W.
c. Measured at source pin (on the side of the package).

SPECIFICATIONS $T_J = 25$ °C, unless otherwise noted

Parameter	Symbol	Test Conditions	Min.	Typ.	Max.	Unit
Static						
Drain-Source Breakdown Voltage	V_{DS}	$V_{GS} = 0$ V, $I_D = 250$ μ A	20			V
V_{DS} Temperature Coefficient	$\Delta V_{DS}/T_J$	$I_D = 250$ μ A		26.5		mV/°C
$V_{GS(th)}$ Temperature Coefficient	$\Delta V_{GS(th)}/T_J$		-7.3			
Gate-Source Threshold Voltage	$V_{GS(th)}$	$V_{DS} = V_{GS}$, $I_D = 250$ μ A	1.5	2.3	3	V
Gate-Source Leakage	I_{GSS}	$V_{DS} = 0$ V, $V_{GS} = \pm 20$ V			± 100	nA
Zero Gate Voltage Drain Current	I_{DSS}	$V_{DS} = 20$ V, $V_{GS} = 0$ V			1	μ A
		$V_{DS} = 20$ V, $V_{GS} = 0$ V, $T_J = 55$ °C			10	
On-State Drain Current ^a	$I_{D(on)}$	$V_{DS} \geq 5$ V, $V_{GS} = 10$ V	25			A
Drain-Source On-State Resistance ^a	$R_{DS(on)}$	$V_{GS} = 10$ V, $I_D = 25$ A		0.0013	0.0016	Ω
		$V_{GS} = 4.5$ V, $I_D = 25$ A		0.0021	0.0025	
Forward Transconductance ^a	g_{fs}	$V_{DS} = 10$ V, $I_D = 25$ A		95		S
Dynamic^b						
Input Capacitance	C_{iss}	$V_{DS} = 10$ V, $V_{GS} = 0$ V, $f = 1$ MHz		8800		pF
Output Capacitance	C_{oss}		1600			
Reverse Transfer Capacitance	C_{rss}		600			
Total Gate Charge	Q_g	$V_{DS} = 10$ V, $V_{GS} = 10$ V, $I_D = 25$ A		102	155	nC
		$V_{DS} = 10$ V, $V_{GS} = 4.5$ V, $I_D = 20$ A		46	70	
	26					
	8					
Gate-Source Charge	Q_{gs}					
Gate-Drain Charge	Q_{gd}			8		
Gate Resistance	R_g	$f = 1$ MHz		0.9	1.35	Ω
Turn-On Delay Time	$t_{d(on)}$	$V_{DD} = 10$ V, $R_L = 1$ Ω $I_D \cong 10$ A, $V_{GEN} = 4.5$ V, $R_g = 1$ Ω		180	270	ns
Rise Time	t_r			215	325	
Turn-Off Delay Time	$t_{d(off)}$			50	75	
Fall Time	t_f			15	25	
Turn-On Delay Time	$t_{d(on)}$	$V_{DD} = 10$ V, $R_L = 1$ Ω $I_D \cong 10$ A, $V_{GEN} = 10$ V, $R_g = 1$ Ω		25	40	
Rise Time	t_r			55	85	
Turn-Off Delay Time	$t_{d(off)}$			55	85	
Fall Time	t_f			10	15	
Drain-Source Body Diode Characteristics						
Continuous Source-Drain Diode Current	I_S	$T_C = 25$ °C			60	A
Pulse Diode Forward Current ^a	I_{SM}				100	
Body Diode Voltage	V_{SD}	$I_S = 10$ A		0.8	1.2	V
Body Diode Reverse Recovery Time	t_{rr}	$I_F = 10$ A, $di/dt = 100$ A/ μ s, $T_J = 25$ °C		56	85	ns
Body Diode Reverse Recovery Charge	Q_{rr}			60	90	nC
Reverse Recovery Fall Time	t_a			26		ns
Reverse Recovery Rise Time	t_b			30		

Notes:

- a. Pulse test; pulse width ≤ 300 μ s, duty cycle ≤ 2 %.
b. Guaranteed by design, not subject to production testing.

Stresses beyond those listed under "Absolute Maximum Ratings" may cause permanent damage to the device. These are stress ratings only, and functional operation of the device at these or any other conditions beyond those indicated in the operational sections of the specifications is not implied. Exposure to absolute maximum rating conditions for extended periods may affect device reliability.

TYPICAL CHARACTERISTICS 25 °C, unless otherwise noted

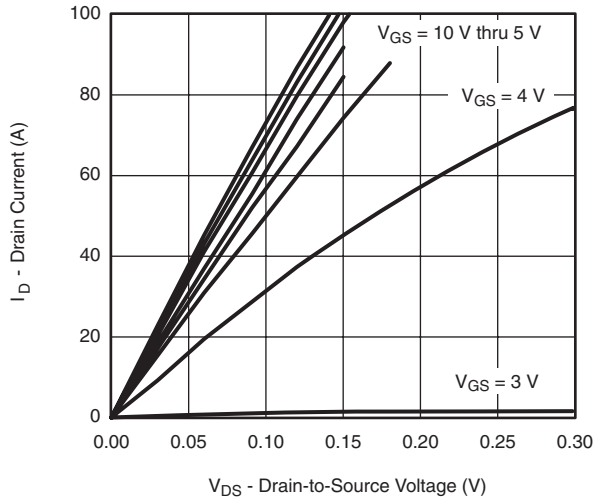

Output Characteristics

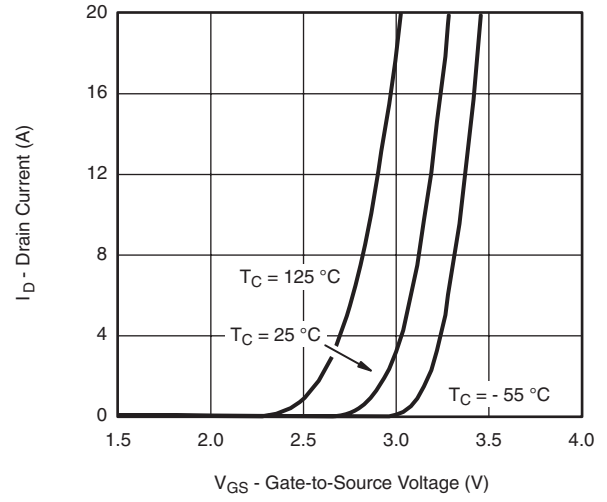

Transfer Characteristics

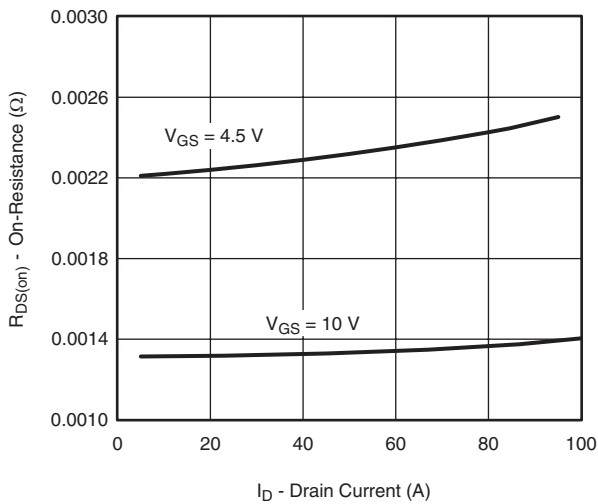

On-Resistance vs. Drain Current and Gate Voltage

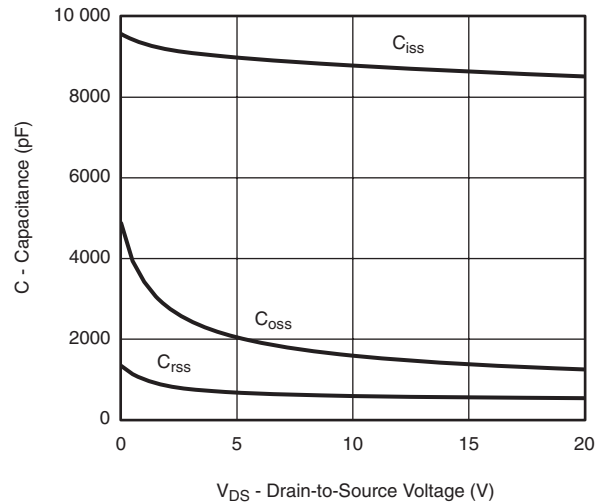

Capacitance

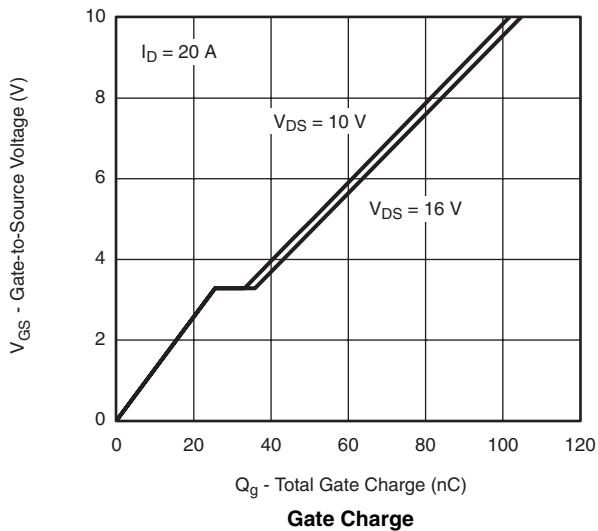

Gate Charge

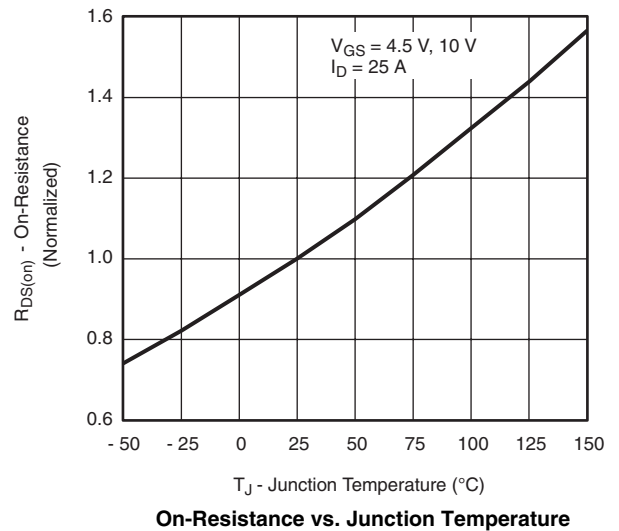

On-Resistance vs. Junction Temperature

TYPICAL CHARACTERISTICS 25 °C, unless otherwise noted

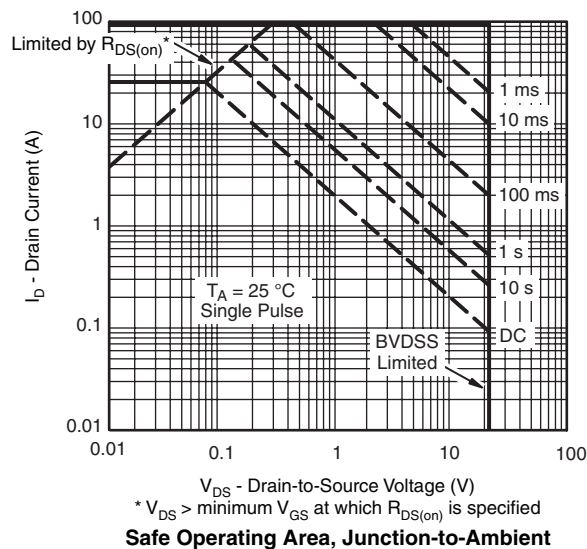
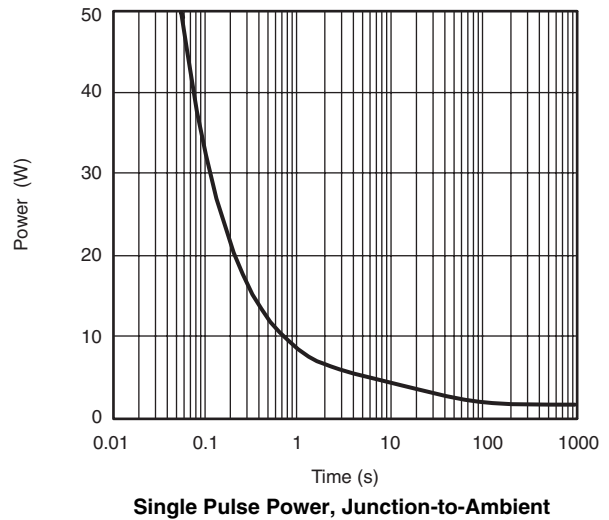
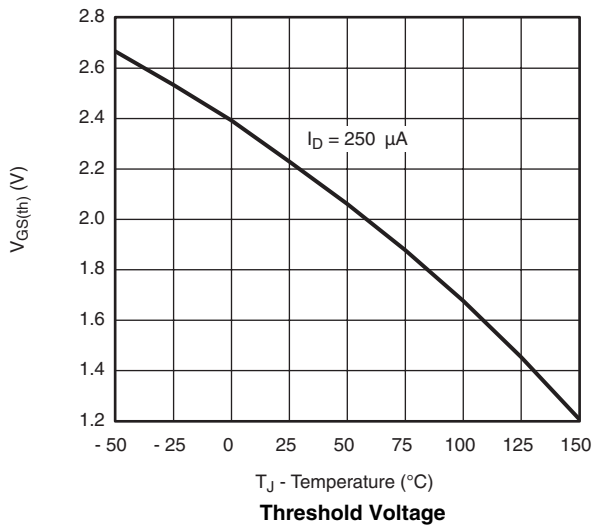
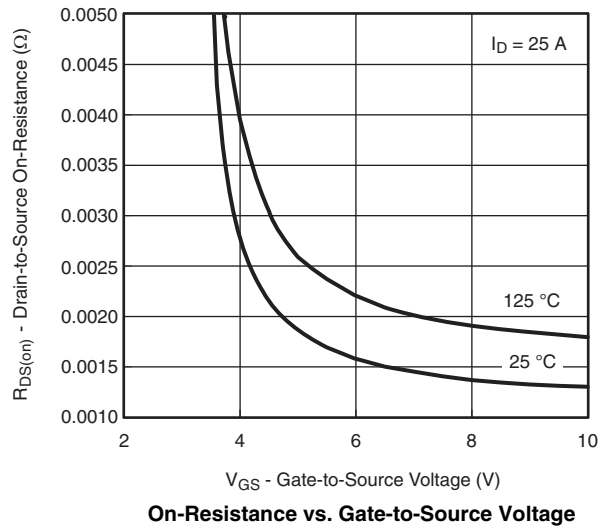
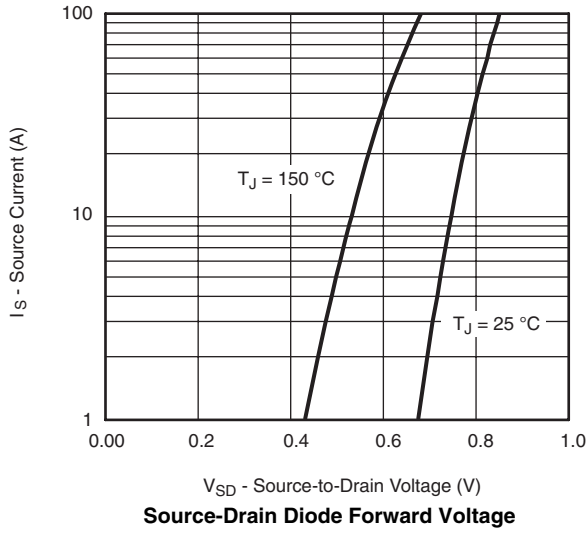

TYPICAL CHARACTERISTICS 25 °C, unless otherwise noted

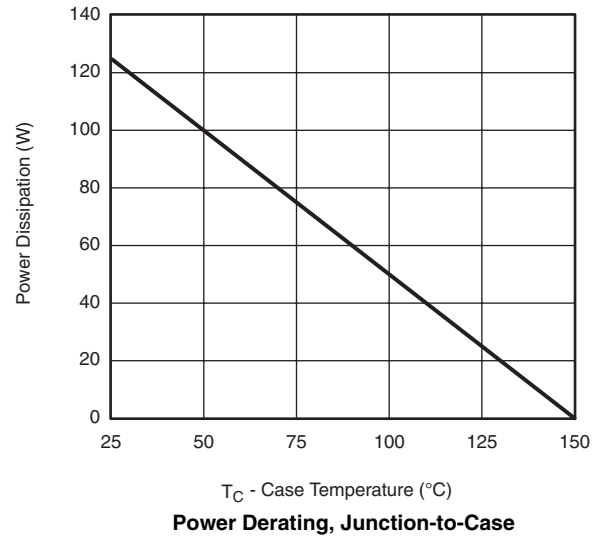
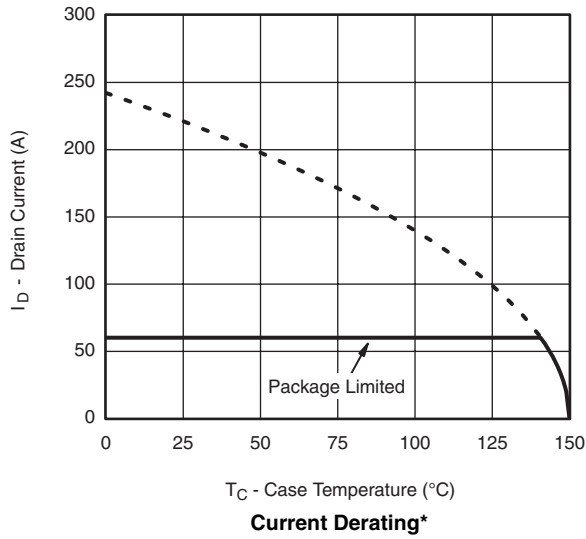

* The power dissipation P_D is based on $T_{J(max)} = 150$ °C, using junction-to-case thermal resistance, and is more useful in settling the upper dissipation limit for cases where additional heatsinking is used. It is used to determine the current rating, when this rating falls below the package limit.

TYPICAL CHARACTERISTICS 25 °C, unless otherwise noted

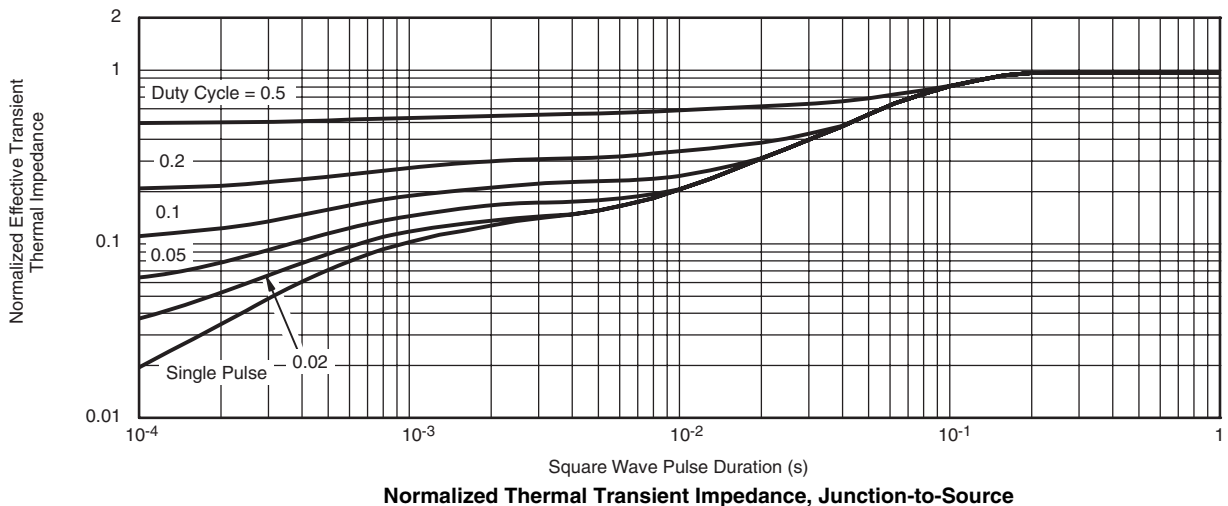
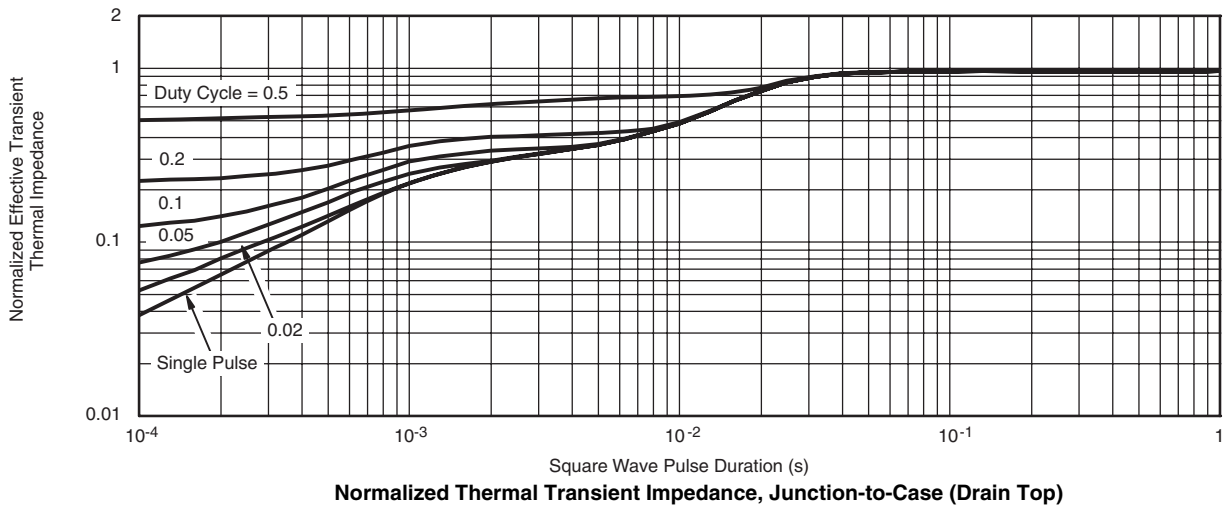
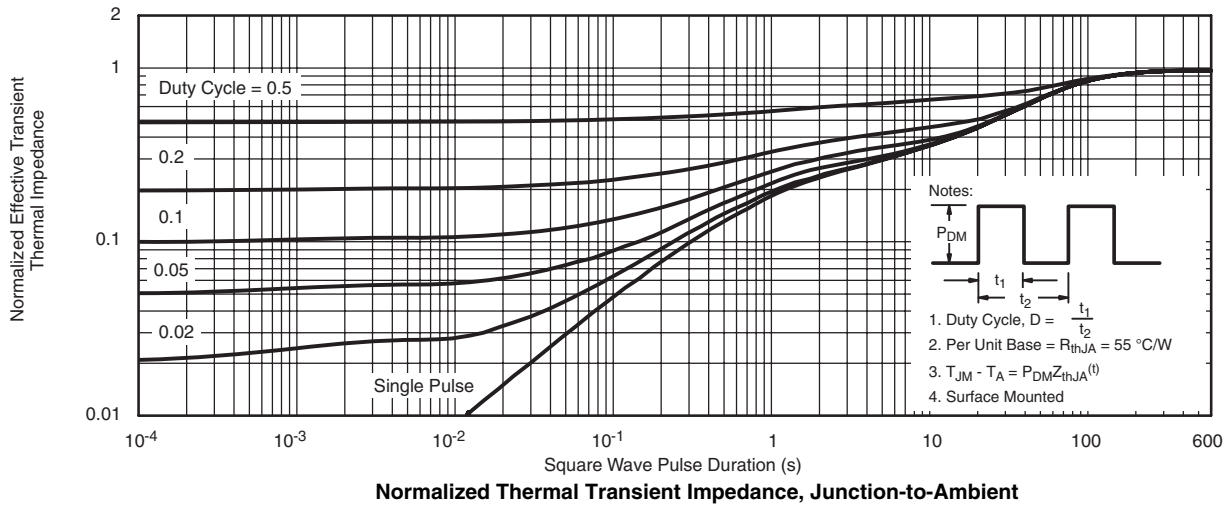

Vishay Siliconix maintains worldwide manufacturing capability. Products may be manufactured at one of several qualified locations. Reliability data for Silicon Technology and Package Reliability represent a composite of all qualified locations. For related documents such as package/tape drawings, part marking, and reliability data, see www.vishay.com/ppg?73739.

POLARPAK™ OPTION L

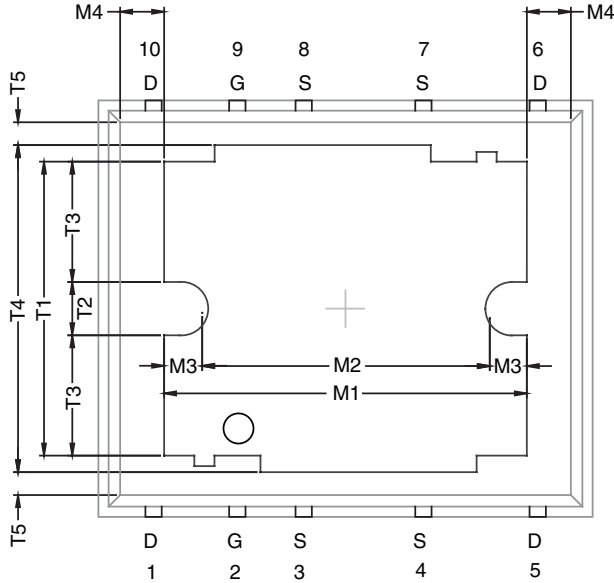

(Top View)



DETAIL Z



Product datasheet/information page contain links to applicable package drawing.

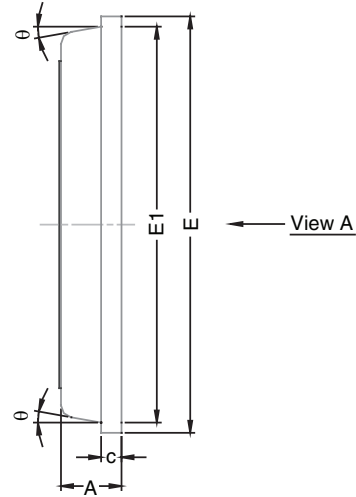

View A



View A
(Bottom View)

Package Information

Vishay Siliconix



DIM	MILLIMETERS			INCHES		
	MIN.	NOM.	MAX.	MIN.	NOM.	MAX.
A	0.75	0.80	0.85	0.030	0.031	0.033
A1	0.00	-	0.05	0.000	-	0.002
b1	0.48	0.58	0.68	0.019	0.023	0.027
b2	0.41	0.51	0.61	0.016	0.020	0.024
b3	2.19	2.29	2.39	0.086	0.090	0.094
b4	0.89	1.04	1.19	0.035	0.041	0.047
b5	0.23	0.33	0.43	0.009	0.013	0.017
c	0.20	0.25	0.30	0.008	0.010	0.012
D	6.00	6.15	6.30	0.236	0.242	0.248
D1	5.74	5.89	6.04	0.226	0.232	0.238
E	5.01	5.16	5.31	0.197	0.203	0.209
E1	4.75	4.90	5.05	0.187	0.193	0.199
H1	0.23	-	-	0.009	-	-
H2	0.45	-	0.56	0.018	-	0.022
H3	0.31	0.41	0.51	0.012	0.016	0.020
H4	0.45	-	0.56	0.018	-	0.022
K1	4.22	4.37	4.52	0.166	0.172	0.178
K2	1.08	1.13	1.18	0.043	0.044	0.046
K3	1.37	-	-	0.054	-	-
K4	0.24	-	-	0.009	-	-
M1	4.30	4.50	4.70	0.169	0.177	0.185
M2	3.43	3.58	3.73	0.135	0.141	0.147
M3	0.22	-	-	0.009	-	-
M4	0.05	-	-	0.002	-	-
P1	0.15	0.20	0.25	0.006	0.008	0.010
T1	3.48	3.64	4.10	0.137	0.143	0.161
T2	0.56	0.76	0.95	0.022	0.030	0.037
T3	1.20	-	-	0.047	-	-
T4	3.90	-	-	0.153	-	-
T5	0	0.18	0.36	0.000	0.007	0.014
θ	0°	10°	12°	0°	10°	12°

ECN: T-08441-Rev. C, 11-Aug-08
DWG: 5946

Notes

Millimeters govern over inches.

RECOMMENDED MINIMUM PADS FOR PolarPAK® Option L and S



Recommended Minimum for PolarPAK Option L and S
 Dimensions in mm/(Inches)
 No External Traces within Broken Lines
 Dot indicates Gate Pin (Part Marking)



Disclaimer

ALL PRODUCT, PRODUCT SPECIFICATIONS AND DATA ARE SUBJECT TO CHANGE WITHOUT NOTICE TO IMPROVE RELIABILITY, FUNCTION OR DESIGN OR OTHERWISE.

Vishay Intertechnology, Inc., its affiliates, agents, and employees, and all persons acting on its or their behalf (collectively, "Vishay"), disclaim any and all liability for any errors, inaccuracies or incompleteness contained in any datasheet or in any other disclosure relating to any product.

Vishay makes no warranty, representation or guarantee regarding the suitability of the products for any particular purpose or the continuing production of any product. To the maximum extent permitted by applicable law, Vishay disclaims (i) any and all liability arising out of the application or use of any product, (ii) any and all liability, including without limitation special, consequential or incidental damages, and (iii) any and all implied warranties, including warranties of fitness for particular purpose, non-infringement and merchantability.

Statements regarding the suitability of products for certain types of applications are based on Vishay's knowledge of typical requirements that are often placed on Vishay products in generic applications. Such statements are not binding statements about the suitability of products for a particular application. It is the customer's responsibility to validate that a particular product with the properties described in the product specification is suitable for use in a particular application. Parameters provided in datasheets and / or specifications may vary in different applications and performance may vary over time. All operating parameters, including typical parameters, must be validated for each customer application by the customer's technical experts. Product specifications do not expand or otherwise modify Vishay's terms and conditions of purchase, including but not limited to the warranty expressed therein.

Except as expressly indicated in writing, Vishay products are not designed for use in medical, life-saving, or life-sustaining applications or for any other application in which the failure of the Vishay product could result in personal injury or death. Customers using or selling Vishay products not expressly indicated for use in such applications do so at their own risk. Please contact authorized Vishay personnel to obtain written terms and conditions regarding products designed for such applications.

No license, express or implied, by estoppel or otherwise, to any intellectual property rights is granted by this document or by any conduct of Vishay. Product names and markings noted herein may be trademarks of their respective owners.