

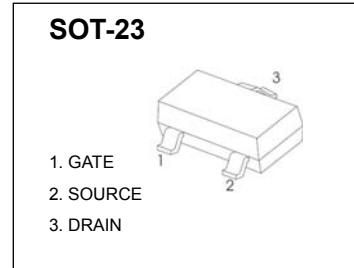

**SOT-23 Plastic-Encapsulate MOSFETS**

**CJ3404** N-Channel Enhancement Mode Field Effect Transistor

<b>V<sub>(BR)DSS</sub></b>	<b>R<sub>DS(on)MAX</sub></b>	<b>I<sub>D</sub></b>
30V	30mΩ@ 10V	5.8A
	42mΩ@4.5V	



**DESCRIPTION**

The CJ3404 use advanced trench technology to provide excellent R<sub>DS(ON)</sub> and low gate charge. This device is suitable for use as a load switch or in PWM applications. The source leads are separated to allow a Kelvin connection to the source, which may be used to bypass the source inductance.

**MARKING**

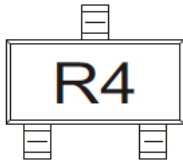

**Equivalent Circuit**

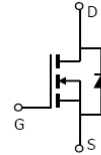

**Maximum ratings (T<sub>a</sub>=25°C unless otherwise noted)**

Parameter	Symbol	Value	Unit
Drain-source voltage	V <sub>DS</sub>	30	V
Gate-source voltage	V <sub>GS</sub>	±20	V
Continuous drain current (t ≤10s)	I <sub>D</sub>	5.8	A
Pulsed drain current *	I <sub>DM</sub>	30	A
Thermal resistance from junction to ambient	R <sub>θJA</sub>	357	°C/W
Junction temperature	T <sub>J</sub>	150	°C
Storage temperature	T <sub>stg</sub>	-55~ 150	°C

\* Repetitive rating : Pulse width limited by maximum junction temperature.

## MOSFET ELECTRICAL CHARACTERISTICS

$T_a=25^\circ\text{C}$  unless otherwise specified

Parameter	Symbol	Test Condition	Min	Typ	Max	Units
<b>STATIC PARAMETERS</b>						
Drain-source breakdown voltage	$V_{(BR)DSS}$	$V_{GS} = 0V, I_D = 250\mu A$	30			V
Zero gate voltage drain current	$I_{DSS}$	$V_{DS} = 30V, V_{GS} = 0V$			1	$\mu A$
Gate-body leakage current	$I_{GSS}$	$V_{GS} = \pm 20V, V_{DS} = 0V$			$\pm 100$	nA
Gate threshold voltage	$V_{GS(th)}$	$V_{DS} = V_{GS}, I_D = 250\mu A$	1	1.4	3	V
Drain-source on-resistance (note 1)	$R_{DS(on)}$	$V_{GS} = 10V, I_D = 5.8A$		23	30	m $\Omega$
		$V_{GS} = 4.5V, I_D = 4.8A$		31	42	m $\Omega$
Forward transconductance (note 1)	$g_{FS}$	$V_{DS} = 5V, I_D = 5.8A$	5			S
Diode forward voltage	$V_{SD}$	$I_S = 1A$			1	V
<b>DYNAMIC PARAMETERS (note 2)</b>						
Input capacitance	$C_{iss}$	$V_{DS} = 15V, V_{GS} = 0V, f = 1MHz$			820	pF
Output capacitance	$C_{oss}$			118		pF
Reverse transfer capacitance	$C_{rss}$			85		pF
Gate resistance	$R_g$	$V_{DS} = 0V, V_{GS} = 0V, f = 1MHz$			1.5	$\Omega$
<b>SWITCHING PARAMETERS (note 2)</b>						
Turn-on delay time	$t_{d(on)}$	$V_{GS} = 10V, V_{DS} = 15V,$ $R_L = 2.6\Omega, R_{GEN} = 3\Omega$			6.5	ns
Turn-on rise time	$t_r$			3.1		ns
Turn-off delay time	$t_{d(off)}$			15.1		ns
Turn-off fall time	$t_f$			2.7		ns

**Note :**

1. Pulse Test : Pulse width  $\leq 300\mu s$ , duty cycle  $\leq 0.5\%$ .
2. These parameters have no way to verify.

# Typical Characteristics

### Output Characteristics

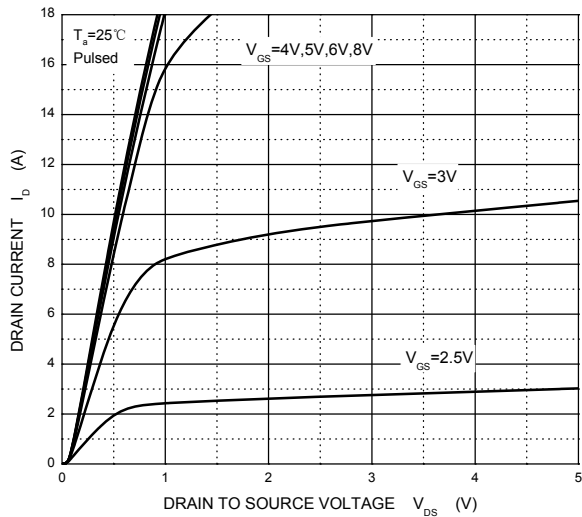

### Transfer Characteristics

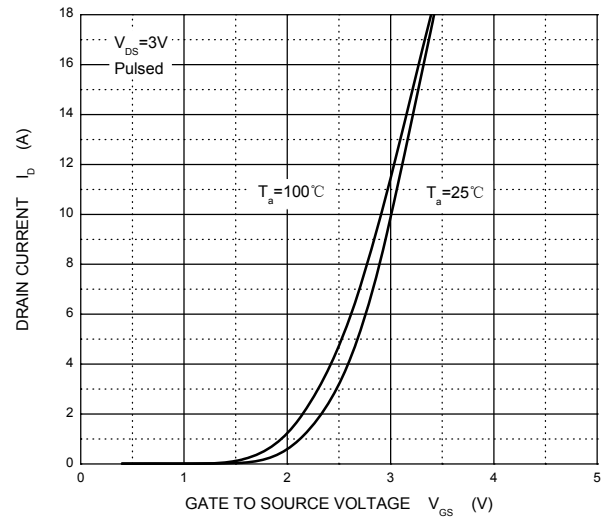

### $R_{DS(ON)}$ — $I_D$

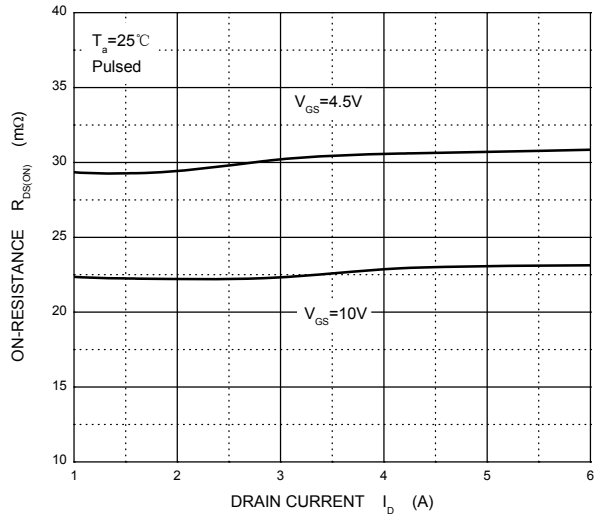

### $R_{DS(ON)}$ — $V_{GS}$

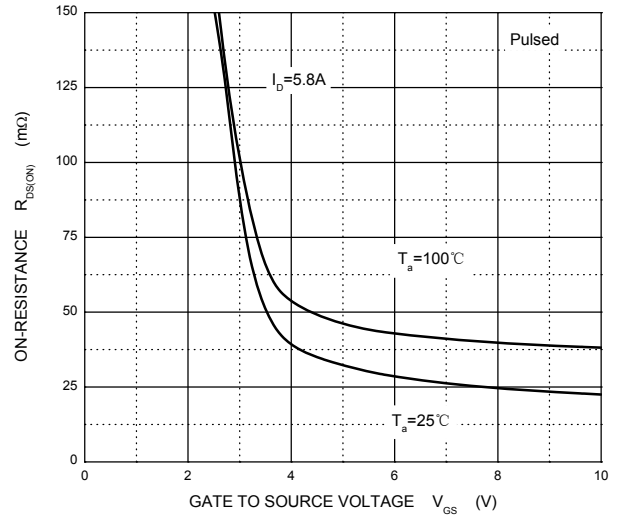

### $I_S$ — $V_{SD}$

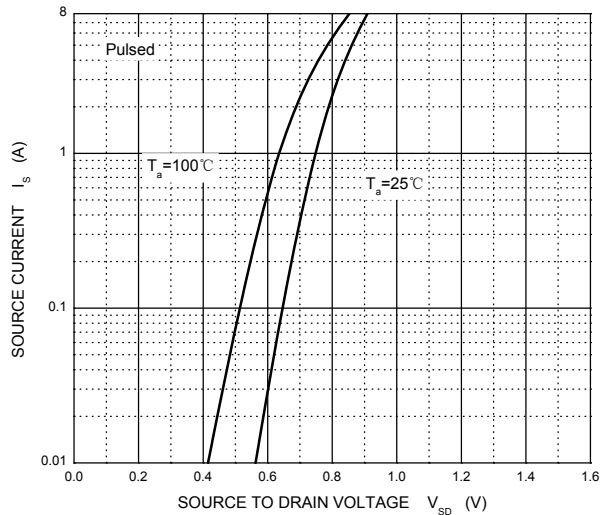

### Threshold Voltage

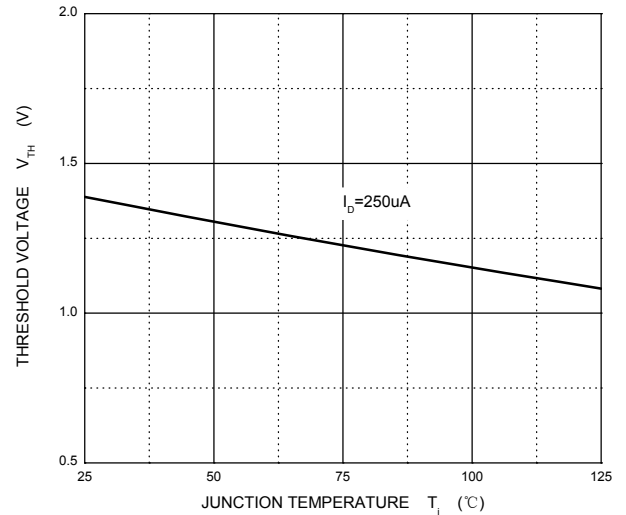

## SOT-23 Package Outline Dimensions

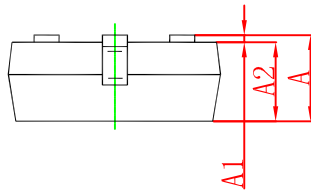
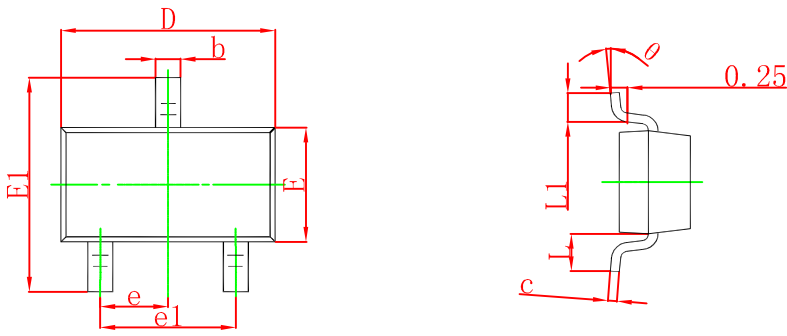

Symbol	Dimensions In Millimeters		Dimensions In Inches	
	Min	Max	Min	Max
A	0.900	1.150	0.035	0.045
A1	0.000	0.100	0.000	0.004
A2	0.900	1.050	0.035	0.041
b	0.300	0.500	0.012	0.020
c	0.080	0.150	0.003	0.006
D	2.800	3.000	0.110	0.118
E	1.200	1.400	0.047	0.055
E1	2.250	2.550	0.089	0.100
e	0.950 TYP		0.037 TYP	
e1	1.800	2.000	0.071	0.079
L	0.550 REF		0.022 REF	
L1	0.300	0.500	0.012	0.020
$\theta$	0°	8°	0°	8°

## SOT-23 Suggested Pad Layout

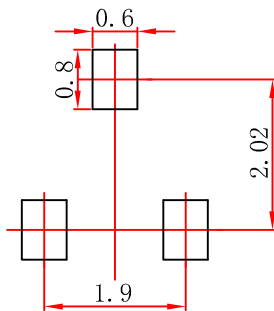

- Note:
1. Controlling dimension: in millimeters.
  2. General tolerance:  $\pm 0.05\text{mm}$ .
  3. The pad layout is for reference purposes only.

### NOTICE

JCET reserve the right to make modifications, enhancements, improvements, corrections or other changes without further notice to any product herein. JCET does not assume any liability arising out of the application or use of any product described herein.

# SOT-23 Tape and Reel

## SOT-23 Embossed Carrier Tape

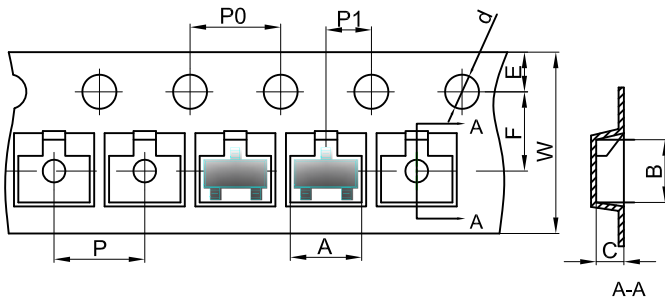

### Packaging Description:

SOT-23 parts are shipped in tape. The carrier tape is made from a dissipative (carbon filled) polycarbonate resin. The cover tape is a multilayer film (Heat Activated Adhesive in nature) primarily composed of polyester film, adhesive layer, sealant, and anti-static sprayed agent. These reeled parts in standard option are shipped with 3,000 units per 7" or 17.8cm diameter reel. The reels are clear in color and is made of polystyrene plastic (anti-static coated).

Dimensions are in millimeter

Pkg type	A	B	C	d	E	F	P0	P	P1	W
SOT-23	3.15	2.77	1.22	Ø1.50	1.75	3.50	4.00	4.00	2.00	8.00

## SOT-23 Tape Leader and Trailer

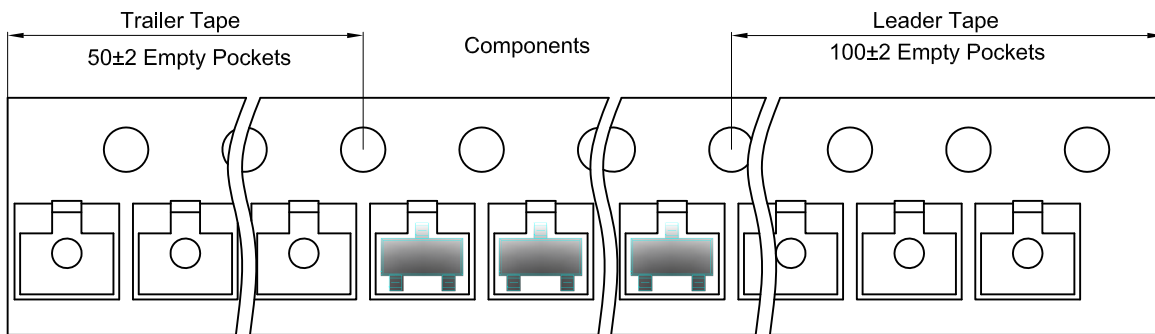

## SOT-23 Reel

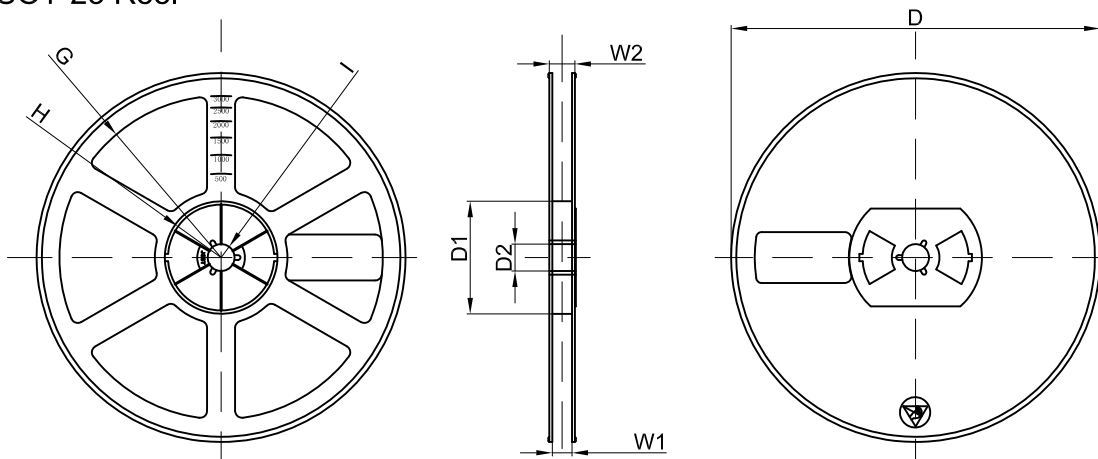

Dimensions are in millimeter

Reel Option	D	D1	D2	G	H	I	W1	W2
7"Dia	Ø178.00	54.40	13.00	R78.00	R25.60	R6.50	9.50	12.30

REEL	Reel Size	Box	Box Size(mm)	Carton	Carton Size(mm)	G.W.(kg)
3000 pcs	7 inch	45,000 pcs	203×203×195	180,000 pcs	438×438×220	