

MAPX	MODIFICATION	DATE
------	--------------	------

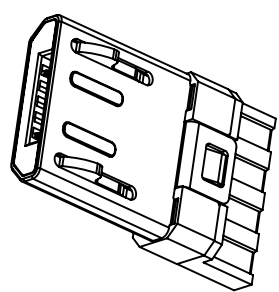
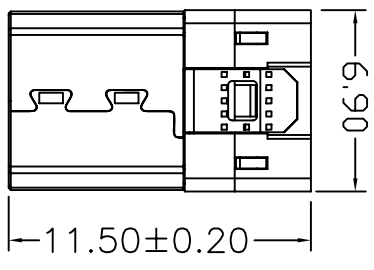
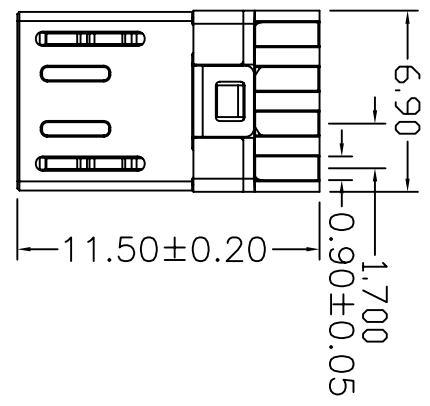

MICRO-USB-5PIN SOLDER TAIL
焊线式

特性: Specifications
电器 Electrical:

接触阻抗: Contact Resistance
30milliohms MAX

耐电压: Dielectric Withstanding Voltage
50V AC AT sea Level

绝缘阻抗: Insulation Resistance:
100MEGA ohms MIN

材料: Material:

塑胶: Housing:Hing Temperature Thermoplastics,
UL 94V-0LCP料耐高温塑胶

端子: Contact: C5I91 0.2料厚

外壳: copper: 不锈钢 0.2料厚

电镀: Finish:

端子: Contact: Plated Gold in Mating Area;
Tin/Lead On Solder Tails

接触点镀金1u, 脚镀锡铅

外壳: Shell:

Tin/Lead Plating 镀镍

Ordering Informating

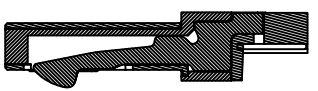
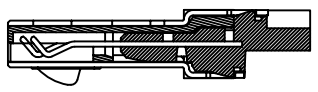
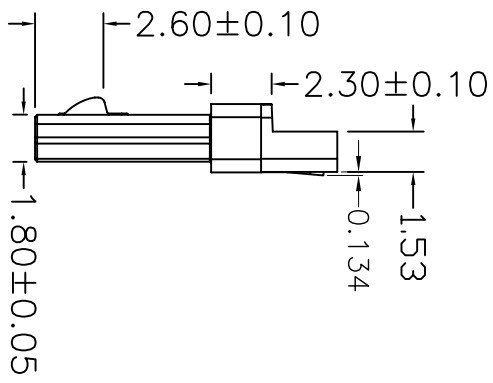
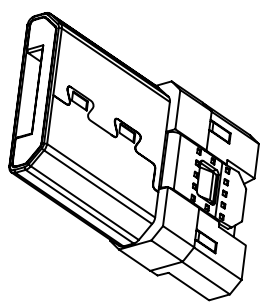
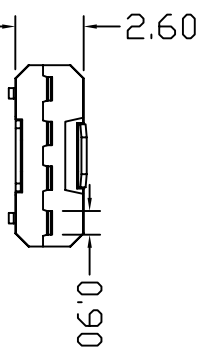
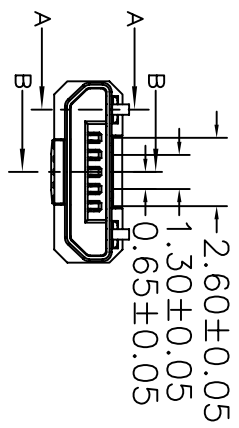

SECTION B-B

SECTION A-A

深圳市精拓金电子有限公司

产品图 PRODUCT CHART DWG		公差一览表 TOLERANCE UNLESS OTHERWISE	
X	±0.35	X	±5°
X	±0.30	X	±2°
XX	±0.20	XX	±1°
XXX	±0.10	XXX	±0.5°
单位 UNITS	MM	制图 DRAWING	Gavin
比例 SCALE	1:1	审核 CHKD	郭治富
日期 DATE	2015-06-19	核准 APPD	黄国荣
制图料号 PRODUCT PART NO		产品名称 PRODUCT NO	microUSB5P公焊线11.5
角法 VIEW		版本 VER	A0