

LED DRIVER SPECIFICATIONS

Customer's Part Number:

MOONS' Part Number:

4696350002902

Model:

PU025H070AQ_CLKS

P/N:

CUSTOMER'S APPROVAL STAMP

Please sign back after your approval. The specifications will come into force when we receive purchase order.

DWG	CHK	STANDARD	APPD

- **Features**
- Input voltage: 90-305VAC
 - Built-in active PFC function: 0.99 Typ.
 - Low THD: 10% Typ.
 - High efficiency: 86% Typ.
 - IP66 design for indoor or outdoor installations
 - High surge immunity
 - Support Time-shared dimming function
 - Compliance to worldwide safety regulations for lighting

■ Specification			
PU025H070AQ_CLKS			
Input	Efficiency(120Vac) _{Note.1}	85%(Typ.)	
	Efficiency(220Vac) _{Note.1}	86%(Typ.)	
	Voltage Range (V) _{Note.2}	90 ~ 305Vac, OR 127~ 430Vdc	
	Voltage Rated (V) _{Note.2}	100-277Vac	
	Frequency Range (Hz)	47~63	
	Power Factor		0.99 (Typ.)with 85%~100% load,at 120Vac
			0.97(Typ.) with 85%~100% load,at 220Vac
			>0.9 with 85%~100% load, at 100~277Vac
	THD		10% (Typ.), at 220Vac input, with 80%~100% load conditions
			<20% with 80%~100% load, at 100~277Vac
AC Current(Max)		0.4A at 100VAC input, 0.2A at 230VAC	
Inrush Current(Max.)		15A at 230Vac input 25°C Cold Start (time wide=500uS, measured at 50% Ipeak,Not applicable for the inrush current to Noise Filter for less than 0.2ms)	
Leakage Current(Max.)		0.5mA at 277Vac/60Hz	
Output	Output Voltage range (V)	18-36	
	Rated Current(mA)	700	
	Rated Power (W)	25.2	
	Ripple Current	<30%((PK-AV) /AV) full load)	
	Current Tolerance	5%	
	Line Regulation	5%	
	Load Regulation	5%	
	Turn on delay Time	<1.2s, at 120Vac; <0.75s, at 230Vac	
Protection	Over Voltage(V)	<50 Protection type: Voltage limiting,output will not exceed the upper limit voltage , recovers automatically after fault condition is removed.	
	Over Current	-	
	Short Circuit	Protection type: Hiccup mode. recovers automatically after short is removed.	
Environment	Operating Temp.	-40~+60°C(Refer to 'Derating Curve')	
	Tc	90°C max	
	Operating Humidity	20~95% RH non-condensing	
	Storage Temp., Humidity	-40~+85°C , 10-95%RH	
	Temp. Coefficient	0.03%/°C (0~50°C)	
Safety & EMC	Vibration	10-500Hz,5G 12min/cycle , period for 72min each along X、 Y、 Z axes	
	Safety Standard	UL8750, UL1310, CSA-C22.2 NO. 223-M91, EN61347-1, EN61347-2-13	
	Withstand Voltage	I/P-O/P:3.75KVAC	
	Isolation Resistance	I/P-O/P:100M Ohms (500VDC/25°C/70%RH)	
	EMC Emission	EN55015/FCC Part 15 Class B, EN61000-3-2 Class C, EN61000-3-3	
Others	EMC Immunity	EN61000-4-2,3,4,5,6,8,11 , EN61547(Surge: L-N 2kV)	
	MTBF	300,000 Hours,measured at full load,25°C ambient temperature	
	Lifetime	50,000 Hours at Tc 75°C(Refer to*Life Time VS. Tcase (Ref.)*)	
	Dimension	80 x 78 x 27 (mm) (LxWxH)	
	Weight(Typ.)	0.18 kg	

Note.1: Measured at full load and steady-state temperature in 25°C ambient; Note. 2: Derating may be needed under low input voltages , Please Refer to 'Derating Curve' ; Note. 3: All parameters NOT specially mentioned are measured at 230VAC input , rated load and 25°C ambient temperature ;

subject to change without notice

Page 3 of 8

SHANGHAI MOONS' AUTOMATION CONTROL CO., LTD.

Add: No.168, Mingjia Road, Shanghai 201107, P.R.China

Tel: +86 (0)21 52634688 Website: www.moons.com.cn

Derating Curve

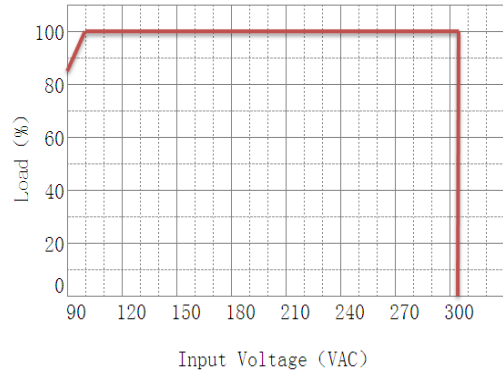
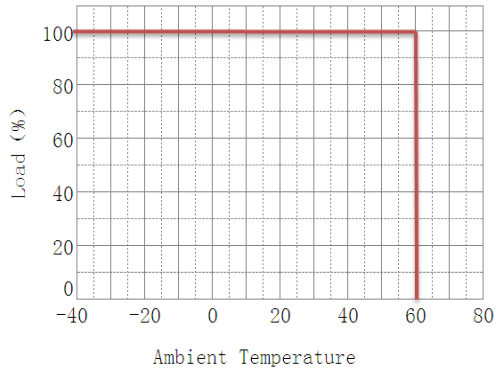

Power Factor VS. Load Curve

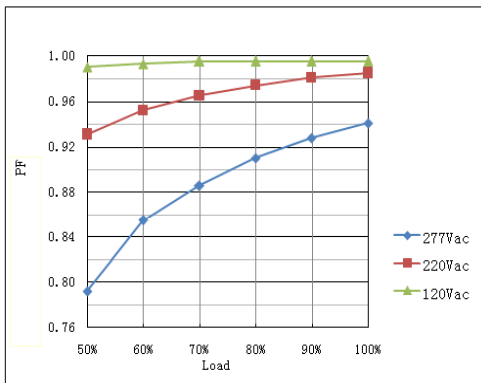

Efficiency VS. Load Curve

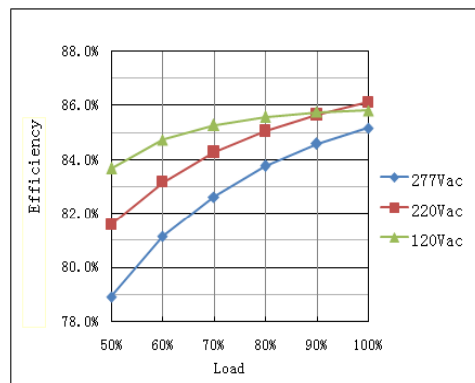

THD Curve

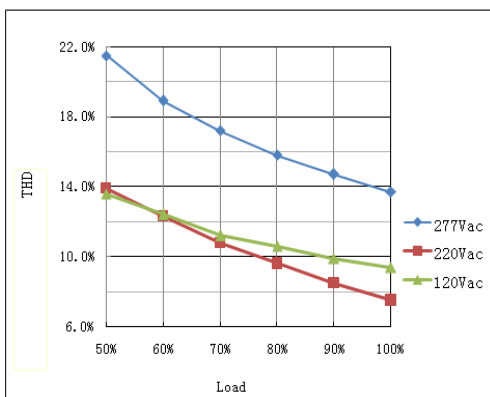

Life Time VS. Tcase (Ref.)

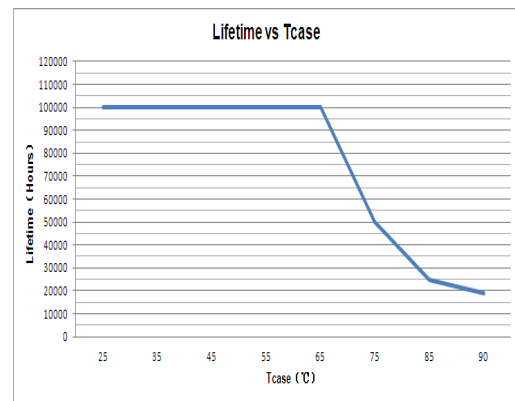

■ **Instruction**

1.Field Programmable Topology

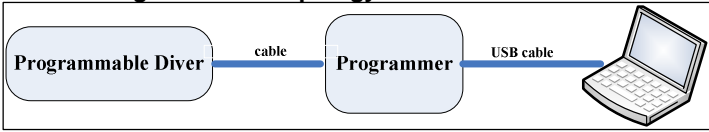

The programmable driver can be programmed by using special PC software and the programmer module.

2.Dimming Interface Description

Pin description

Pin	Name	Value	Description
1	Vaux 12V	9V-13.2V	Passive dimmers power supply
2	Dim+/Program	0-10V	Dimming/Programming input
3	Dim-	0V	DC Ground

CLKS DIMMING PROGRAMMING INTERFACE

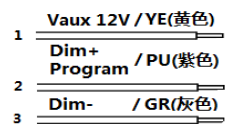

3.Dimming Software Function Instruction

v **Adjustable Output Current(AOC)**

Adjustable Output Current(AOC)

Module Current: mA

Max Current: mA Power: W

Users can set the rated current between 10%*Max Current and 100%*Max Current

■ **PWM**

Input a PWM signal from the 2nd pin(Dim+/Program) of the dimming interface to change the output current. User can set "Positive Logic" or "Negative Logic" of the PWM signal. PWM duty circle: 1%~99%(it has both positive and negative logics), frequency: 500Hz~5kHz, 3V~10V is high, 0.3V~0.8V is low.

v **Adjustable Startup Time(AST)**

Adjustable Startup Time(AST)

Start Fadeup Time: s

Set driver's "Start Fade up Time". It means how much time the driver costs to achieve the "Module Current" that the user set. The valid value is 0s, 1s, 2s, 5s, 10s, 20s, 40s.

Dimming Interface Selection(DIS)

1-10V PWM Smart Midnight ClockDIM Fixed ClockDIM No Dimming

PWM Logic(PVML)

Positive Or Negative Logic:

v **Fade Time(FT)**

Fade Time(FT)

Fadeup Time: s

Set driver's "Fade up Time". This function is available in the Smart Midnight ClockDIM and Fixed ClockDIM mode; It means how much time the driver costs to achieve another dimming level from previous dimming level. The valid value is 0s, 1s, 2s, 5s, 10s, 20s, 40s.

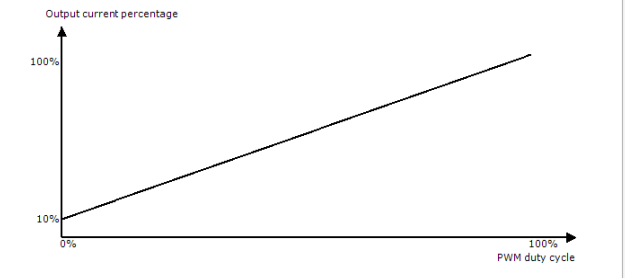

v **1-10V**

Allow users to set the max and min output current and corresponding output voltage to clarify the 1-10V dimming curve. Input a 0~10V signal from 2nd pin of the dimming interface. Default: input ≤1V, output current 10%; input ≥ 8.5V, output current 100%.

Dimming Interface Selection(DIS)

1-10V PWM Smart Midnight ClockDIM Fixed ClockDIM No Dimming

1-10V Min dim level: V %

1-10V Max dim level: V %

Instruction

v Smart Midnight ClockDIM

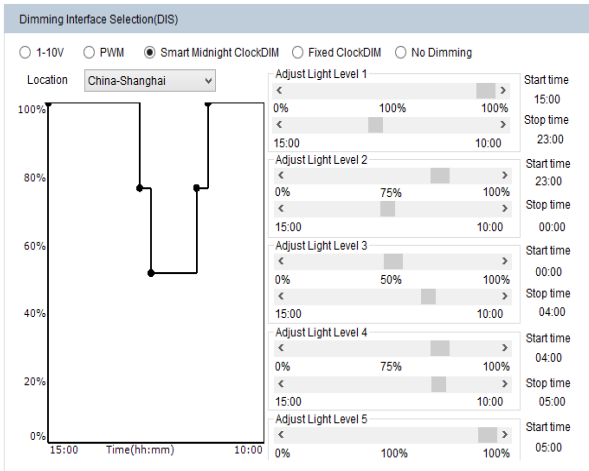

Smart Midnight ClockDIM allows dimming to predefined light levels based on the nightly operating time. With flexibility in setting time and light levels, the user can configure the driver for specific locations and application needs. Using Integrated Dynadimmer, it is possible to set up to 5 dim levels and time intervals. The driver does not have a real time clock. Instead it runs a virtual clock, determined by the length of nightly operating hours. After 3 ON-OFF cycles, the driver will calculate the virtual clock time. A valid ON-time is defined as a period during which the driver operates continuously for ≥ 4 hours to ≤ 24 hours. For example, if the requirement in summer is: 23:00-00:00: 75%, 00:00-04:00: 50%, 04:00-05:00: 75% (other time 100% or Off). The driver should be powered on for 7h, so it can calculate the virtual clock time as 22:00. Then we can set the dimming plan: 22:00-23:00: 100%, 23:00-00:00: 75%, 00:00-04:00: 50%, 04:00-05:00: 75%. From summer to winter, the valid ON-time changes day by day. The driver should be powered on for 17h in winter, and it also can calculate the virtual clock time as 17:00. Then the dimming plan is 17:00-23:00: 100%, 23:00-00:00: 75%, 00:00-04:00: 50%, 04:00-05:00: 75%, 05:00-10:00: 100%. From the above, if we set the dimming plan as shown in the picture, after repeating the driver ON-time for 3 consecutive days, the dimming plan takes effect from the 4th day onwards. Each day the driver powered on, it has a different start time according to the virtual clock time. So the driver can satisfy different requirements for different seasons.

v Constant Light Output(CLO)

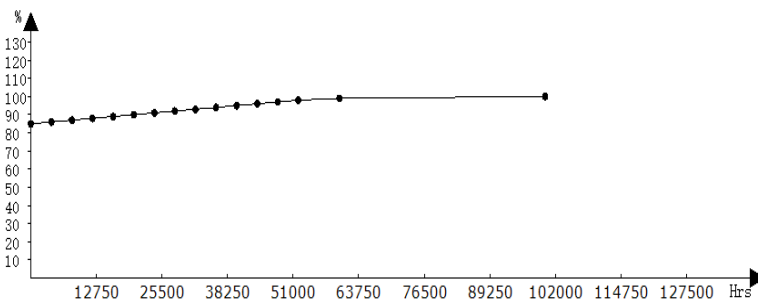
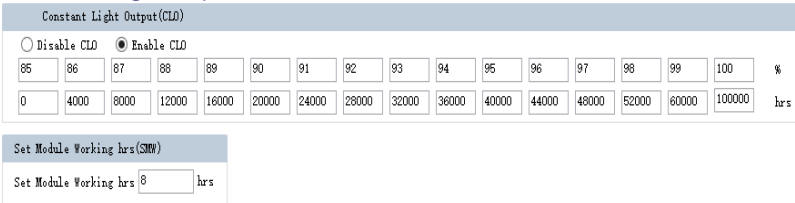

v Fixed ClockDIM

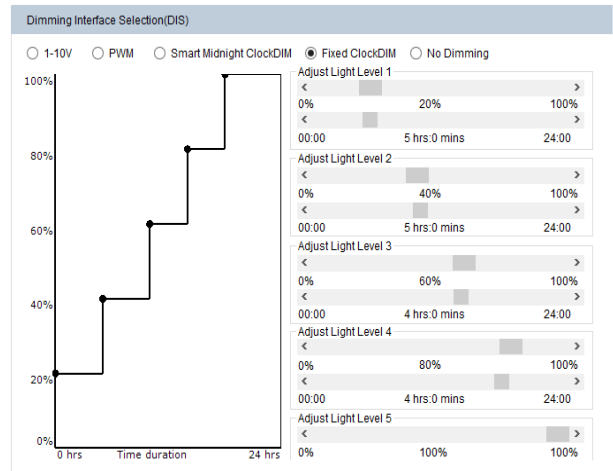

Allow users to separate 24hrs into 5 sections and corresponding output current.

v No Dimming

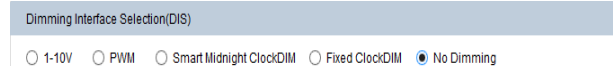

The driver will be in constant output mode.

v Set MODULE Working hrs(SMW)

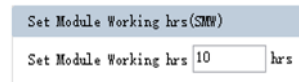

User can check how much time the driver works through this function.

Traditional light sources suffer from depreciation in light output over time. This applies to LED light sources as well. The CLO feature enables LED solutions to deliver constant lumen output through the life of the light engine. Based on the type of LEDs used, heat sinking and driver current, it is possible to estimate the depreciation of light output for specific LEDs and this information can be entered into the driver. The driver counts the number of light source working hours and will increase output current based on this input to enable CLO. When the CLO feature is enabled, the driver nominal output current will be defined by the CLO percentage as shown by the equation below:

$$\text{Driver target nominal output current} = \text{CLO percentage} * \text{AOC}$$
 For example, in the CLO profile shown in Figure, between 52,000-60,000 working hours, the CLO percentage is set at 98%. Assuming the nominal AOC is set to 500mA, the driver output current with CLO enabled will be $0.98 \times 500 = 600$ mA.
 The CLO percentage can be set to a value between 85%-100%, in increments of 1%. The LED module working hours can be set at any value between (0-100,000 hours).

■ **Programmable Plan**

v Adjustable Output Current(AOC)

Adjustable Output Current(AOC)

Module Current mA

Max Current mA Power W

v Smart Midnight ClockDIM

Dimming Interface Selection(DIS)

1-10V
 PWM
 Smart Midnight ClockDIM
 Fixed ClockDIM
 No Dimming

Location

Adjust Light Level	Start time	Stop time	Light Level
Adjust Light Level 1	15:00	23:00	100%
Adjust Light Level 2	23:00	00:00	75%
Adjust Light Level 3	00:00	04:00	50%
Adjust Light Level 4	04:00	05:00	75%
Adjust Light Level 5	05:00	10:00	100%

■ **Mechanical Specification**

Dimensions (Unit: mm)

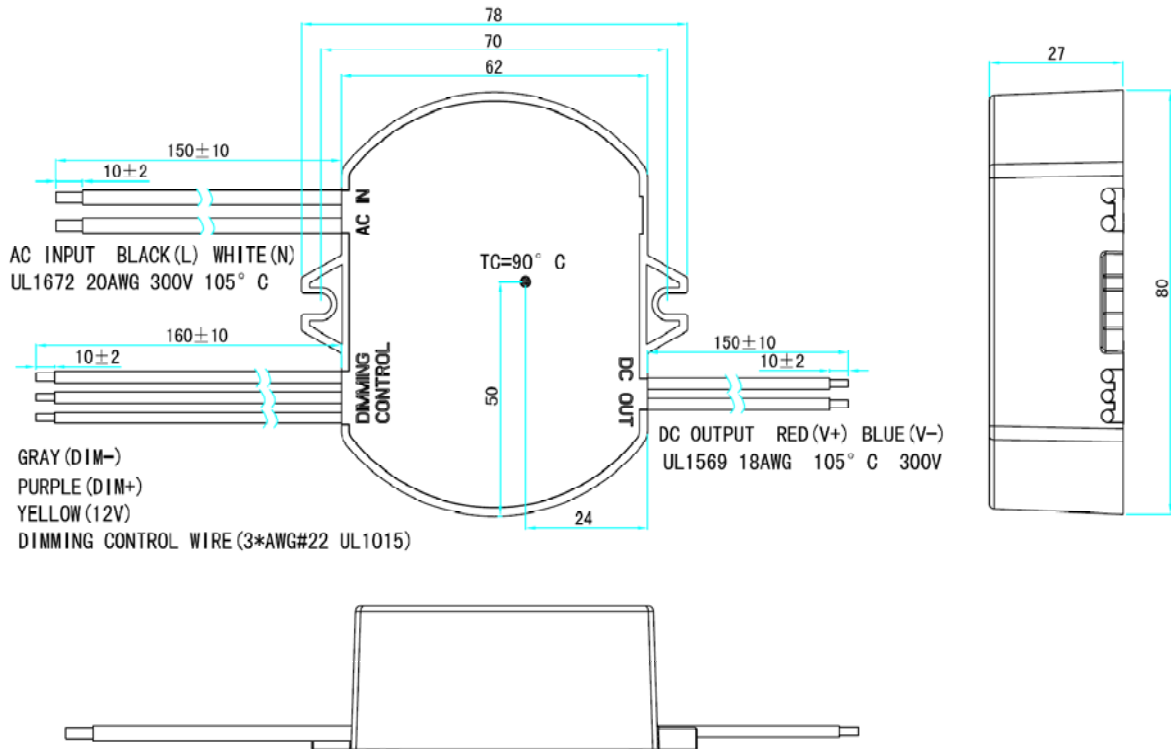

■ **Nameplate**

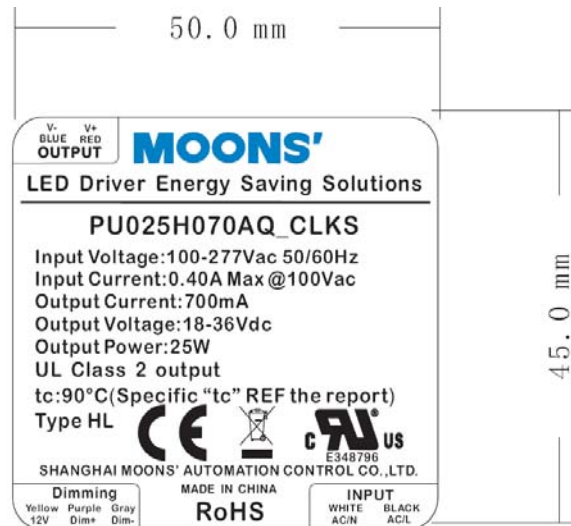

RoHS Compliance:

Our products comply with the European Directive 2002/95/EC, calling for the elimination of lead and other hazardous substances from electronic products.