



- Features**
- Input voltage: 90-305Vac
 - Built-in active PFC function 0.98 Typ.
 - High efficiency: up to 90% Typ.
 - Built-in Lightning protection
 - Waterproof (IP67)
 - Constant Current / 0-10V Dimming
 - / Clock Dimming(CLK)/PWM Dimming
 - Protection: OVP, SCP, OTP
 - Full Power at 65%Iomax ~ 100%Iomax (Constant Power)

Specification						
Model (MU075MxxxAQ_CP)		105	150	210	300	420
Input	Efficiency(120Vac)	88.0%	87.0%	86.0%	86.0%	85.0%
	Efficiency(220Vac)	90.0%	89.0%	88.0%	88.0%	87.0%
	Voltage Range (Vac)	90 ~ 305				
	Rated Input Voltage (Vac)	100-277				
	Frequency Range (Hz)	47-63				
	Power Factor	0.98 (Typical) at 230Vac; >0.9 with 60%~100% load, at 100~277Vac				
	THD	<15% with 80% ~ 100% load, at 100~277Vac; <20% with 50%~100% load, at 100~277Vac				
	AC Current(Typ.)	1.0A MAX at 110VAC				
	Inrush Current(Typ.)	65A at 230Vac input 25 Cold Start (time wide=500uS, measured at 50% Ipeak,Not applicable for the inrush current to Noise Filter for less than 0.2ms)				
Leakage Current(max.)	0.75mA at 277Vac 50Hz input					
Output	Rated Output Voltage (V)	108-72	75-50	54-36	38-25	27-18
	Output Voltage Range (V) ^{Note.1}	108-43	75-30	54-22	38-15	27-11
	Rated Current(mA)	700-1050	1000-1500	1400-2100	2000-3000	2800-4200
	Output Current Range(mA)	70-1050	100-1500	140-2100	200-3000	280-4200
	Rated Power (W)	75(max)				
	Output Current Set Range	6.5%I _{o_max} ~ 100%I _{o_max}				
	Constant Power Output Set	65%I _{o_max} ~ 100%I _{o_max}				
	Ripple Current((PK-AV) /AV)	10% max. (peak-to-average value) at 100% Iout				
	Current Tolerance ^{Note.2}	±5%				
	Line Regulation	±1%				
	Load Regulation	±3%				
	Dimming Control	Setup, Rise Time	0.5s(typ.), measured at 220Vac input			
Hold Up Time		10ms at 220Vac 100% load				
12Vdc Output Voltage (Vdc)		10.8Vmin. ~ 12Vtyp. ~ 13.2Vmax.				
12Vdc Output Current(Vdc)		0mA~20mA max.				
0~10V/DIM+ Voltage		Absolute maximum voltage -10Vmin~20Vmax				
Protection	0~10V/DIM+ Short Current	280uA~450uA (DIM(+)=0)				
	DIMMING FUNCTION	0~10V/10%I _o ~100%I _o ref. Dimming module diagram and dimming cruve				
	Over Voltage(V)	130	90	65	46	33
Environment	Short Circuit	Hiccup mode.The power supply shall be self-recovery when the fault is removed.				
	Over Temperature	Protection type: Resumable mode.when the inside temperature of PSU rise to 100 (Typ.), decreases output current,returning to normal after over temperature is removed.				
	Operating Temp.	-40~+70 (Tc 90)				
Safety & EMC	Operating Humidity	20~95%RH, non-condensing				
	Storage Temp., Humidity	-40~+85 , 10-95%RH				
	Temp. Coefficient	0.03%/ (0~50)				
	Vibration	10~500Hz, 5G 12min/cycle, period for 72min each along X、 Y、 Z axes				
Others	Safety Standard	UL8750, UL1012, CAN/CSA-C22.2No.107.1-01,EN61347-1, EN61347-2-13				
	Withstand Voltage	I/P-O/P:3.75KVAC I/P-FG:1.875KV O/P-FG:1.5KV				
	Isolation Resistance	I/P-O/P、I/P-FG,O/P-FG:100M Ohms/500VDC/25 /70%RH				
	EMC Emission	EN55015 , EN61000-3-2 Class C , EN61000-3-3				
MTBF	EMC Immunity	EN61000-4-2,3,4,5,6,8,11 , EN61547 (Surge L,N-FG 10KV , L-N 10KV)				
	Lifetime	250,000 hours, measured at full load, 25 ambient temperature MIL-HDBK-217F(25)				
	Dimension	173x67.5 x 37mm (LxWxH)				
	Weight	0.8kg				

Note.1: refer to V/I curve

Note.2: At Rated Current ,Includes set up tolerance, line regulation and load regulation.

subject to change without notice

Page 1 of 5

SHANGHAI MOONS' AUTOMATION CONTROL CO., LTD.

Add: No.168, Mingjia Road, Shanghai 201107, P.R.China

Tel: +86 (0)21 52634688 Website: www.moons.com.cn

Derating Curve

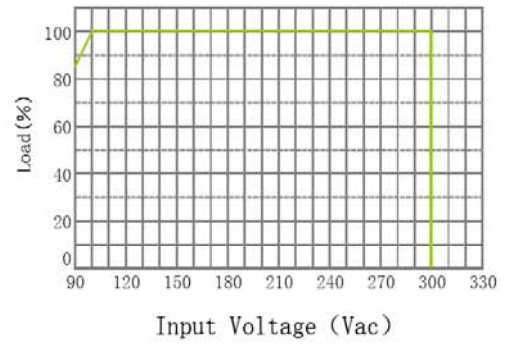
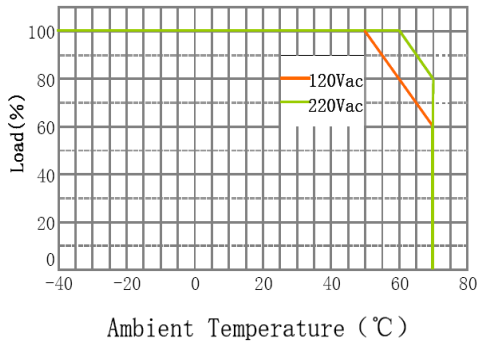

V/I Curve

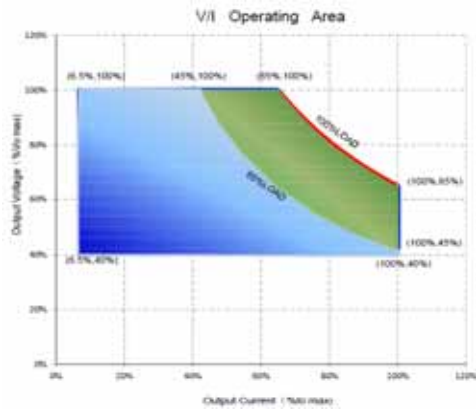

THD Curve

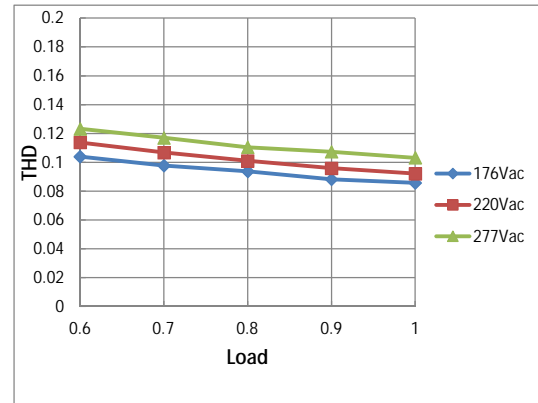

Power Factor VS. Load Curve

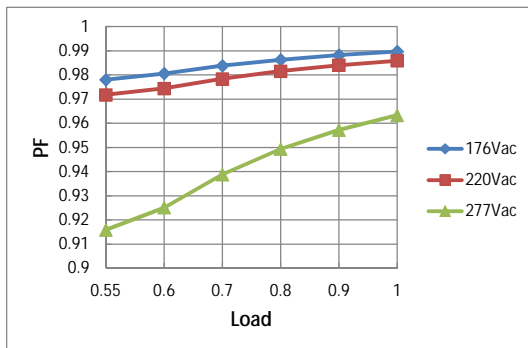

Efficiency VS. Load Curve

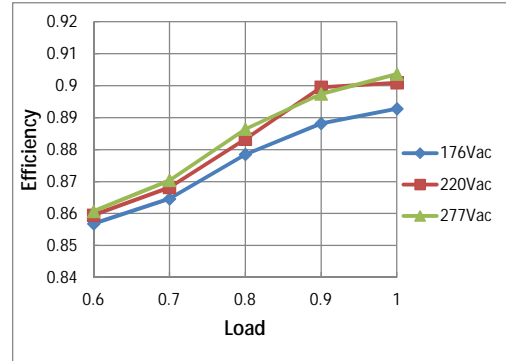

Life Time VS. Tcase (Ref.)

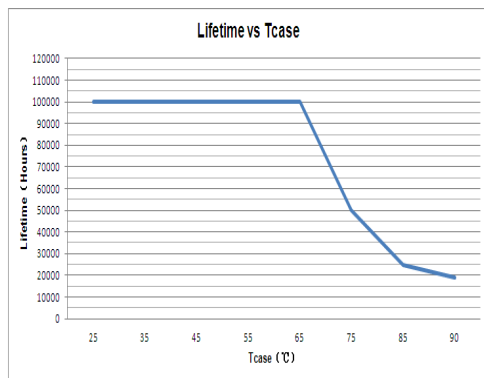

Instruction

1.Field Programmable Topology

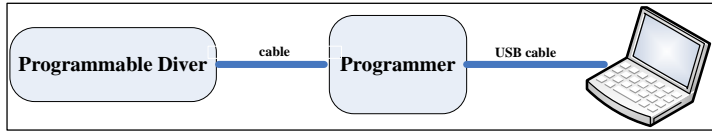

The programmable driver can be programmed by using special PC software and the programmer module.

2.Dimming Interface Description

Pin description

Pin	Name	Value	Description
1	Vaux 12V	10.8V-13.2V	Passive dimmers power supply
2	Dim+/Program	0-10V	Dimming/Programming input
3	Dim-	0V	DC Ground

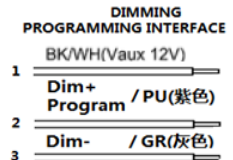

3.Dimming Software Function Instruction

■ Adjustable Output Current(AOC)

Adjustable Output Current(AOC)

Module Current mA

Max Current mA Power W

Users can set the rated current between 7%*Max Current and 100%*Max Current.

■ Adjustable Startup Time(AST)

Adjustable Startup Time (AST)

Start Fadeup Time s

Set driver's "Start Fade up Time". It means how much time the driver costs to achieve the "Module Current" that the user set. The valid value is 0s, 1s, 2s, 5s, 10s, 20s, 40s.

■ Fade Time(FT)

Fade Time(FT)

Fadeup Time s

Set driver's "Fade up Time". This function is available in the Smart Midnight ClockDIM and Fixed ClockDIM mode; It means how much time the driver costs to achieve another dimming level from previous dimming level. The valid value is 0s, 1s, 2s, 5s, 10s, 20s, 40s.

■ 1-10V

Allow users to set the max and min output current and corresponding output voltage to clarify the 1-10V dimming curve. Input a 0~10V signal from 2nd pin of the dimming interface. Default: input 1V, output current 10%; input 8.5V, output current 100%.

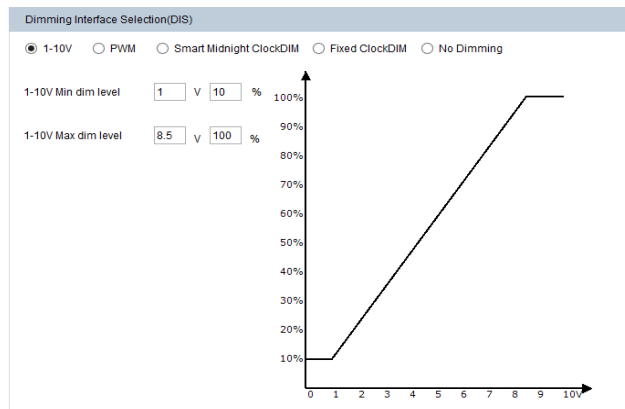

PWM

Input a PWM signal from the 2nd pin(Dim+/Program) of the dimming interface to change the output current. User can set "Positive Logic" or "Negative Logic" of the PWM signal. PWM duty circle: 1%~99%(it has both positive and negative logics), frequency: 500Hz~5kHz, 3V~10V is high, -0.3V~0.8V is low.

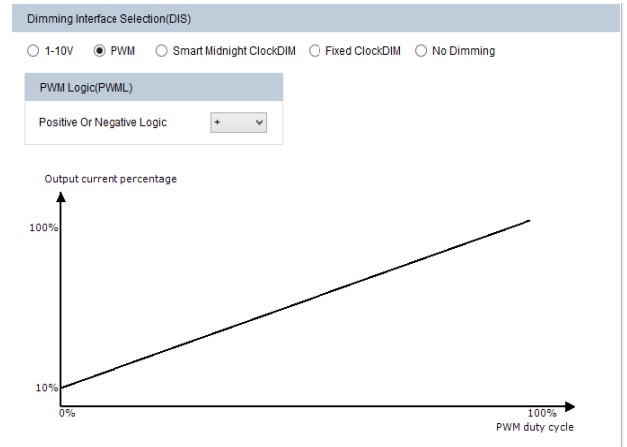

Instruction

■ Smart Midnight ClockDIM

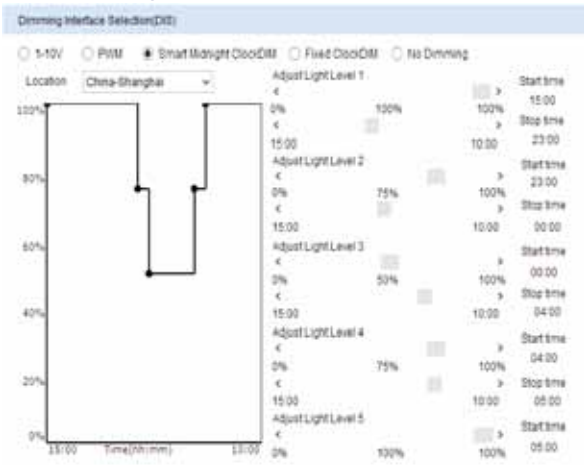

Smart Midnight ClockDIM allows dimming to predefined light levels based on the nightly operating time. With flexibility in setting time and light levels, the user can configure the driver for specific locations and application needs. Using Smart Midnight ClockDIM, it is possible to set up to 5 dim levels and time intervals. The driver does not have a real time clock. Instead it runs a virtual clock, determined by the length of nightly operating hours. After 3 ON-OFF cycles, the driver will calculate the virtual clock time. A valid ON-time is defined as a period during which the driver operates continuously for 4 hours to 24 hours. For example, if the requirement in summer is: 23:00-00:00: 75%, 00:00-04:00: 50%, 04:00-05:00: 75% (other time 100% or Off). The driver should be powered on for 7h, so it can calculate the virtual clock time as 22:00. Then we can set the dimming plan: 22:00-23:00: 100%, 23:00-00:00: 75%, 00:00-04:00: 50%, 04:00-05:00: 75%. From summer to winter, the valid ON-time changes day by day. The driver should be powered on for 17h in winter, and it also can calculate the virtual clock time as 17:00. Then the dimming plan is 17:00-23:00: 100%, 23:00-00:00: 75%, 00:00-04:00: 50%, 04:00-05:00: 75%, 05:00-10:00: 100%. From the above, if we set the dimming plan as shown in the picture, after repeating the driver ON-time for 3 consecutive days, the dimming plan takes effect from the 4th day onwards. Each day the driver powered on, it has a different start time according to the virtual clock time. So the driver can satisfy different requirements for different seasons.

■ Constant Light Output(CLO)

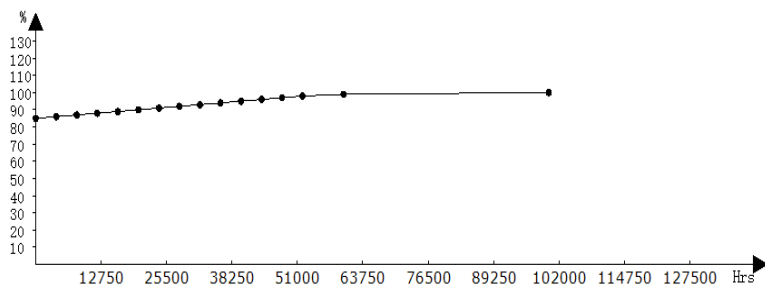
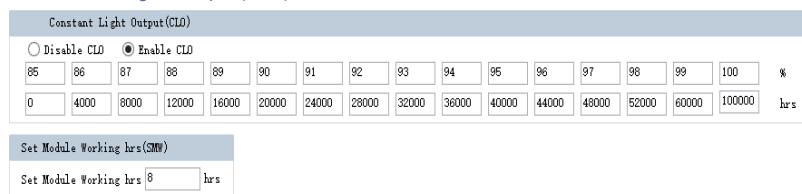

■ Fixed ClockDIM

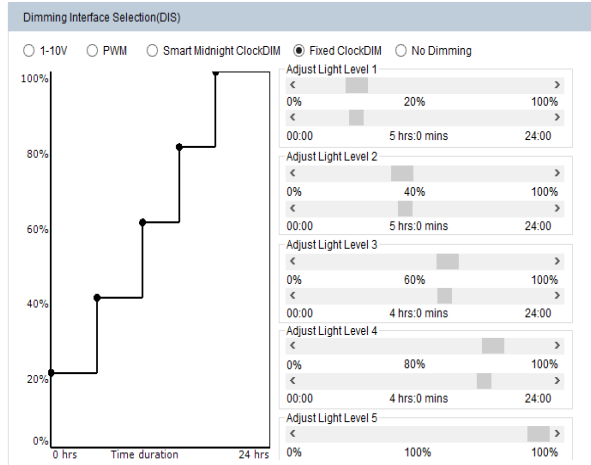

Allow users to separate 24hrs into 5 sections and corresponding output current.

■ No Dimming



The driver will be in constant output mode.

■ Set Module Working hrs(SMW)

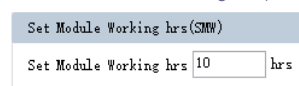

User can check how much time the driver works through this function.

Traditional light sources suffer from depreciation in light output over time. This applies to LED light sources as well. The CLO feature enables LED solutions to deliver constant lumen output through the life of the light engine. Based on the type of LEDs used, heat sinking and driver current, it is possible to estimate the depreciation of light output for specific LEDs and this information can be entered into the driver. The driver counts the number of light source working hours and will increase output current based on this input to enable CLO.

When the CLO feature is enabled, the driver nominal output current will be defined by the CLO percentage as shown by the equation below:
 Driver target nominal output current = CLO percentage * AOC. For example, in the CLO profile shown in Figure, between 52,000-60,000 working hours, the CLO percentage is set at 98%. Assuming the nominal AOC is set to 500mA, the driver output current with CLO enabled will be $0.98 \times 500 = 600 \text{ mA}$.

The CLO percentage can be set to a value between 85%-100%, in increments of 1%. The LED module working hours can be set at any value between (0-100,000 hours).

Mechanical Specification

Dimensions (Unit: mm)

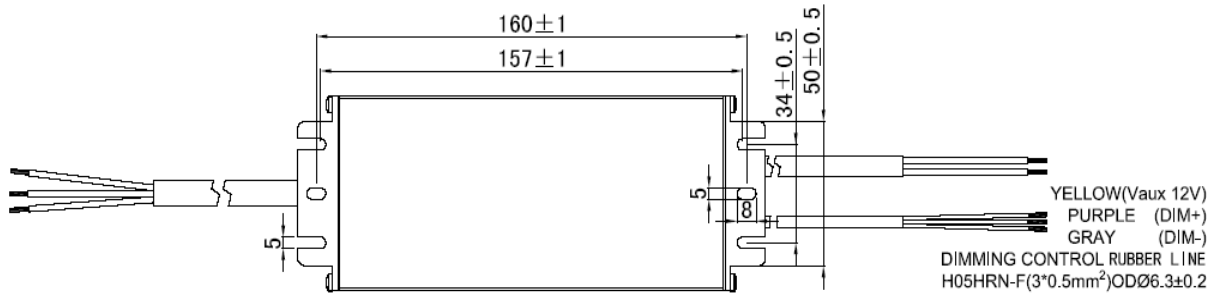

AC INPUT UL SJTW
(3*AWG#18) OD $\phi 7.8 \pm 0.3$
WHITE (ACN)
BLACK (ACL)
GREEN (GND)

DC OUTPUT UL SJTW
(2*AWG#18) OD $\phi 7.3 \pm 0.3$
RED (V+)
BLUE (V-)

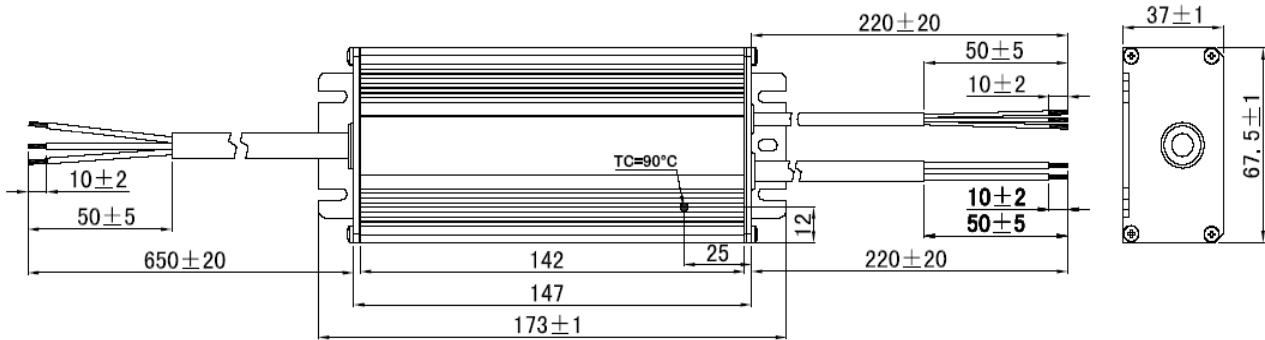
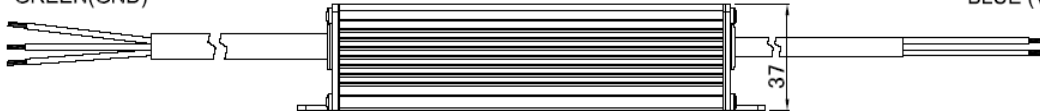

RoHS Compliance:
Our products comply with the European Directive 2002/95/EC, calling for the elimination of lead and other hazardous substances from electronic products.