



High-Precision, Rail-to-Rail I/O Operational Amplifier

General Description

The HTC6133(single) and HTC6233(dual) are high-precision, low-quiescent current amplifier which can offer high input impedance and rail-to-rail input and output. The amplifier uses auto-zeroing techniques to provide low offset voltage(2 μV type) and near zero-drift over time and temperature.

Either single or dual supplies can be used in the range from 2.3V to 5.5V ($\pm 1.15\text{V}$ to $\pm 2.75\text{V}$)

The HTC6133 is available in SC70-5,SOT23-5, MSOP-8 and SOP-8.The HTC6233 is available in MSOP-8 and SOP-8. All versions are specified for operation from $-40\text{ }^{\circ}\text{C}$ to $+125\text{ }^{\circ}\text{C}$.

Features

- Low Offset Voltage: 2 μV (Type)
- Zero-Drift: 0.03 $\mu\text{V}/^{\circ}\text{C}$
- Low Noise: 48 $\text{nV}/\sqrt{\text{Hz}}$
 - 0.1-Hz to 10-Hz Noise: 0.8 μVpp
- Excellent DC Precision:
 - Open-Loop Gain: 135dB
 - PSRR: 110dB
 - CMRR: 110dB
- Gain Bandwidth: 0.4 MHz
- Quiescent Current: 20 μA (Type)
- Supply Range: $\pm 1.15\text{V}$ to $\pm 2.75\text{V}$
- Rail-to-Rail Input and Output

Application

- Bridge Amplifier
- Strain Gauges
- Transducer Applications
- Temperature Measurement
- Electronic Scales
- Medical Instrumentation
- Resistance Temperature Detectors
- Handheld Test Equipment

Pin Configurations

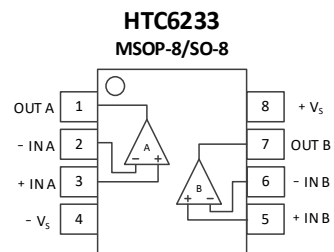
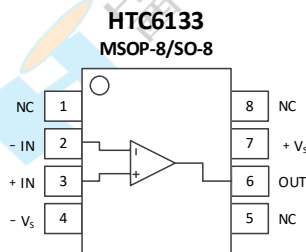
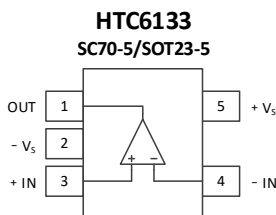

High-Precision, Rail-to-Rail I/O Operational Amplifier
Pin Description

Symbol	Description
-IN	Inverting Input of the Amplifier. The Voltage can go from (V_{S-}) to (V_{S+}).
+IN	Non-Inverting Input of Amplifier. This pin has the same voltage range as -IN.
+V _S	Positive Power Supply. The Voltage is from 2.3V to 5.5V ($\pm 1.15V$ to $\pm 2.75V$).
-V _S	Negative Power Supply. It is normally tied to ground.
OUT	Amplifier Output.
N/C	No Connection.

Ordering Information

Type Number	Package Name	Package Quantity	Marking Code
HTC6133XC5/R6	SC70-5	Tape and Reel,3000	C13XX
HTC6133XT5/R6	SOT23-5	Tape and Reel,3000	C13XX
HTC6133XS8/R8	SOP-8	Tape and Reel,4000	C6133X
HTC6133XV8/R6	MSOP-8	Tape and Reel,3000	C6133X
HTC6233XS8/R8	SOP-8	Tape and Reel,4000	C6233X
HTC6233XV8/R6	MSOP-8	Tape and Reel,3000	C6233X

Recommended Operating Conditions

- Operating voltage range: 2.1V to 5.5V ($\pm 1.05V$ to $\pm 2.75V$)
- Specified temperature range: -40°C to 125°C



High-Precision, Rail-to-Rail I/O, 45-V Operational Amplifier

Absolute Maximum Ratings

Attention: Stresses beyond those listed under Absolute Maximum Ratings may cause permanent damage to the device. Exposure to absolute-maximum-rated conditions for extended periods may affect device reliability.

Parameter	Symbol	Absolute Maximum Rating	Unit
Supply Voltage		$\pm 3, +6(\text{Single})$	V
Input terminal	Voltage	$V_{S-} - 0.5$ to $V_{S+} + 0.5$	V
	Differential Voltage	± 5	V
Temperature	Operating ⁽²⁾ , T_A	-55 to 150	°C
	Storage, T_{stg}	-65 to 150	°C
	Junction, T_J	150	°C
Electrostatic Discharge Voltage	HBM	8	kV

(1) Stresses beyond those listed under Absolute Maximum Ratings may cause permanent damage to the device. These are stress ratings only, which do not imply functional operation of the device at these or any other conditions beyond those indicated under Recommended Operating Conditions. Exposure to absolute-maximum-rated conditions for extended periods may affect device reliability.

(2) Provided device does not exceed maximum junction temperature (T_J) at any time.

High-Precision, Rail-to-Rail I/O Operational Amplifier
Electrical Characteristics
 $V_S=+5V, T_A=25^\circ C, V_{CM}=V_S/2, V_O=V_S/2, R_L=10k\Omega$ connected to $V_S/2$, unless otherwise noted.

Symbol	Parameter	Conditions	Min.	Typ.	Max.	Unit
INPUT CHARACTERISTICS						
V_{OS}	Input offset Voltage			2	15	μV
$V_{OS\ TC}$	Offset voltage drift	$T_A=-40^\circ C$ to $+125^\circ C$		0.03		$\mu V/^\circ C$
I_B	Input bias current	$V_{CM}=V_S/2$		± 100		pA
I_{OS}	Input offset current			± 100		pA
V_{CM}	Common-mode Voltage range	$T_A=-40^\circ C$ to $+125^\circ C$	V_{S-}		V_{S+}	V
CMRR	Common-mode rejection ratio	$V_{S-} < V_{CM} < V_{S+}$	90	110		dB
		$T_A=-40^\circ C$ to $+125^\circ C$	85			dB
A_{VOL}	Open-loop voltage gain	$V_{S-} + 0.3V < V_O < V_{S+} - 0.3V$	105	135		dB
		$T_A=-40^\circ C$ to $+125^\circ C$	100			dB
OUTPUT CHARACTERISTICS						
V_{OH}	High output voltage swing	$R_L=10k\Omega$	$(V_{S+}) - 12$	$(V_{S+}) - 4$		mV
		$T_A=-40^\circ C$ to $+125^\circ C$	$(V_{S+}) - 18$			mV
V_{OL}	Low output voltage swing	$R_L=10k\Omega$		$(V_{S-}) + 4$	$(V_{S-}) + 12$	mV
		$T_A=-40^\circ C$ to $+125^\circ C$			$(V_{S-}) + 18$	mV
I_{SC}	Short-circuit current	Source current	55	65		mA
		$T_A=-40^\circ C$ to $+125^\circ C$	50			mA
		Sink current	48	55		mA
		$T_A=-40^\circ C$ to $+125^\circ C$	45			mA
POWER SUPPLY						
PSRR	Power supply rejection ratio	$V_S=2.1V$ to $5.5V$	90	110		dB
		$T_A=-40^\circ C$ to $+125^\circ C$	80			
I_Q	Quiescent current			20	28	μA
		$T_A=-40^\circ C$ to $+125^\circ C$			35	
NOISE						
e_n	Input voltage noise	$f=0.1Hz$ to $10Hz$ $F=1KHz$		800 48		nV_{pp} nV/\sqrt{Hz}
DYNAMIC PERFORMANCE						
GBW	Gain bandwidth product			0.4		MHz
SR	Slew rate	$G=+1$		0.1		$V/\mu s$
t_{OR}	Overload recovery time	$G=-10$		20		μs



High-Precision, Rail-to-Rail I/O Output Operational Amplifier

Electrical Characteristics

$V_S=+2.7V, T_A=25^\circ C, V_{CM}=V_S/2, V_O=V_S/2, R_L=10k\Omega, R_I=10k\Omega$ connected to $V_S/2$, unless otherwise noted.

Symbol	Parameter	Conditions	Min.	Typ.	Max.	Unit
INPUT CHARACTERISTICS						
V_{OS}	Input offset Voltage			4	20	μV
$V_{OS\ TC}$	Offset voltage drift	$T_A=-40^\circ C$ to $+125^\circ C$		0.03		$\mu V/^\circ C$
I_B	Input bias current	$V_{CM}=V_S/2$		± 100		pA
I_{OS}	Input offset current			± 100		pA
V_{CM}	Common-mode Voltage range	$T_A=-40^\circ C$ to $+125^\circ C$	V_{S-}		V_{S+}	V
CMRR	Common-mode rejection ratio	$V_{S-} < V_{CM} < V_{S+}$	90	110		dB
		$T_A=-40^\circ C$ to $+125^\circ C$	80	100		dB
A_{VOL}	Open-loop voltage gain	$V_{S-} + 0.3V < V_O < V_{S+} - 0.3V$	105	135		dB
		$T_A=-40^\circ C$ to $+125^\circ C$	95			dB
OUTPUT CHARACTERISTICS						
V_{OH}	High output voltage swing	$R_L=10k\Omega$	$(V_{S+}) - 12$	$(V_{S+}) - 3$		mV
		$T_A=-40^\circ C$ to $+125^\circ C$	$(V_{S+}) - 18$			mV
V_{OL}	Low output voltage swing	$R_L=10k\Omega$		$(V_{S-}) + 3$	$(V_{S-}) + 12$	mV
		$T_A=-40^\circ C$ to $+125^\circ C$			$(V_{S-}) + 18$	mV
I_{SC}	Short-circuit current	Source current	17	24		mA
		$T_A=-40^\circ C$ to $+125^\circ C$	14			mA
		Sink current	15	20		mA
		$T_A=-40^\circ C$ to $+125^\circ C$	12			mA
POWER SUPPLY						
PSRR	Power supply rejection ratio	$V_S=2.1V$ to $5.5V$	90	110		dB
		$T_A=-40^\circ C$ to $+125^\circ C$	80			
I_Q	Quiescent current			18	25	μA
		$T_A=-40^\circ C$ to $+125^\circ C$			35	
NOISE						
e_n	Input voltage noise	$f=0.1Hz$ to $10Hz$ $f=1KHz$		800 48		nV_{pp} nV/\sqrt{Hz}
DYNAMIC PERFORMANCE						
GBW	Gain bandwidth product			0.4		MHz
SR	Slew rate	$G = +1$		0.1		$V/\mu s$
t_{OR}	Overload recovery time	$G = -10$		20		μs

High-Precision, Rail-to-Rail I/Output Operational Amplifier

Type Performance Characteristics

$V_S=+5V, T_A=25^\circ C, V_{CM}=V_S/2, V_O=V_S/2, R_L=10k\Omega$ connected to $V_S/2$, unless otherwise noted.

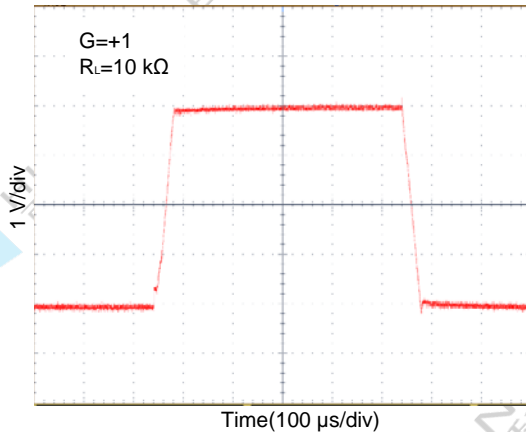

LARGE-SIGNAL STEP RESPONSE at +5V

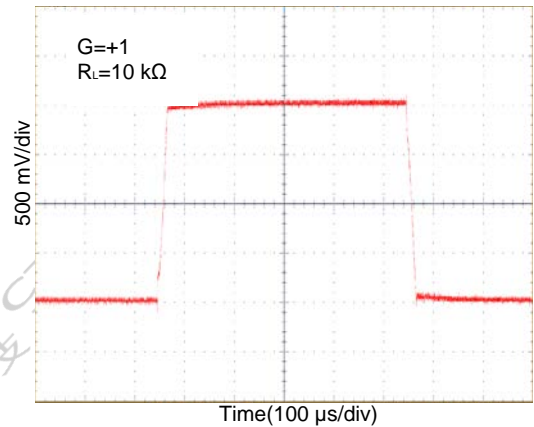

LARGE-SIGNAL STEP RESPONSE at +2.7V

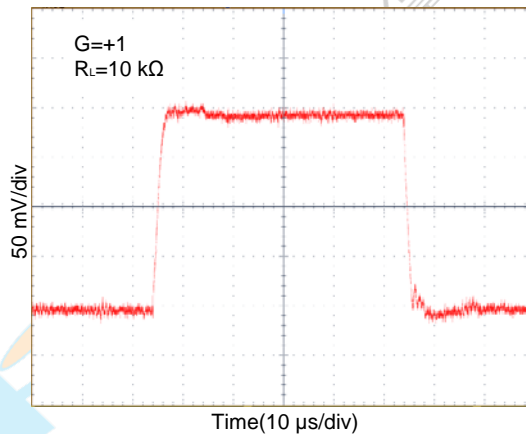

SMALL-SIGNAL STEP RESPONSE at +5V

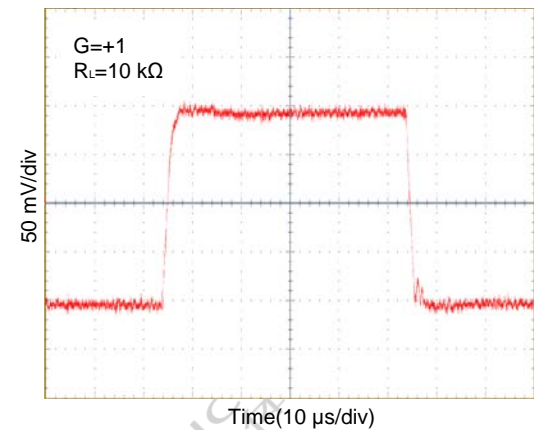

SMALL-SIGNAL STEP RESPONSE at +2.7V

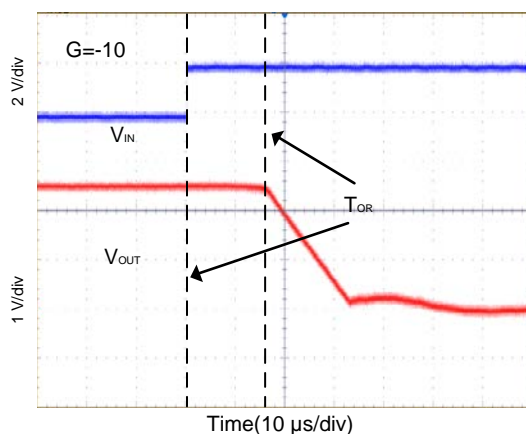

POSITIVE OVERLOAD RECOVERY

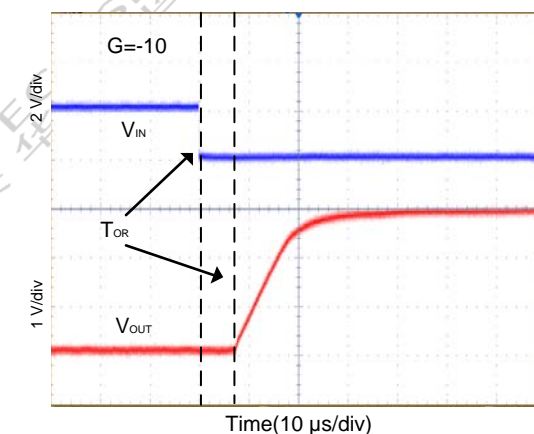

NEGATIVE OVERLOAD RECOVERY



High-Precision, Rail-to-Rail I/O Operational Amplifier

Type Performance Characteristics

$V_S=+5V, T_A=25^\circ C, V_{CM}=V_S/2, V_O=V_S/2, R_L=10k\Omega, R_I=10k\Omega$ connected to $V_S/2$, unless otherwise noted.

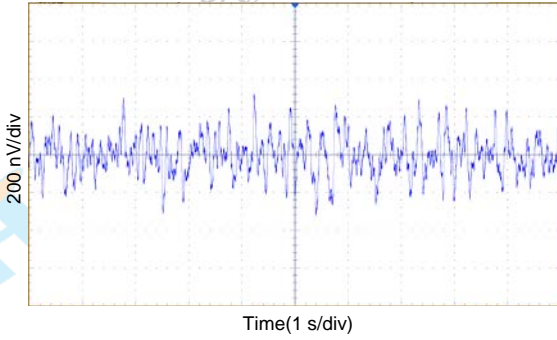

0.1Hz to 10Hz noise

Application Notes

Application Information

The HTC6X33 operational amplifier combines precision offset and drift with excellent overall performance, making it ideal for many precision applications. The precision offset drift of only $0.085 \mu\text{V}/^\circ\text{C}$ provides stability over the entire temperature range. In addition, the device pairs excellent CMRR, PSRR, and AOL dc performance with outstanding low-noise operation. As with all amplifiers, applications with noisy or high-impedance power supplies require decoupling capacitors close to the device pins. In most cases, $0.1\text{-}\mu\text{F}$ capacitors are adequate.

Operating Characteristics

The HTC6X33 is specified for operation from 2.1 V to 5.5 V ($\pm 1.05\text{ V}$ to $\pm 2.75\text{ V}$). Many specifications apply from -40°C to $+125^\circ\text{C}$. Parameters that can exhibit significant variance with regard to operating voltage or temperature are presented in *Typical Characteristics*.

Capacitive Load and Stability

The unity-gain follower (buffer) is the most sensitive configuration to capacitive loading. Direct capacitive loading reduces the phase margin of amplifiers and this results in ringing or even oscillation. Applications that require greater capacitive drive capability should use an isolation resistor between the output and the capacitive load like the circuit in Figure 2. The isolation resistor R_{ISO} and the load capacitor C_L form a zero to increase stability. The bigger the R_{ISO} resistor value, the more stable V_{out} will be. Note that this method results in a loss of gain accuracy because R_{ISO} forms a voltage divider with the R_L .

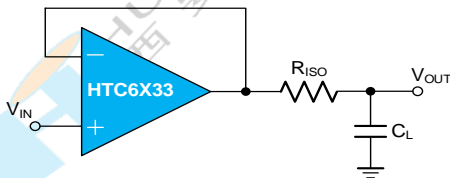

Figure 1. Indirectly Driving Heavy Capacitive Load

An improvement circuit is shown in Figure 3. It provides DC accuracy as well as AC stability. The R_F provides the DC accuracy by connecting the inverting signal with the output.

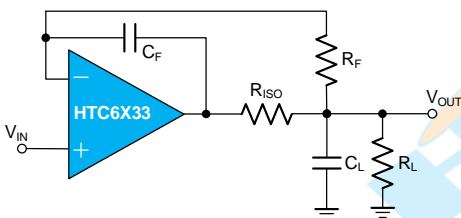

Figure2. Indirectly Driving Capacitive Load with DC Accuracy

Input Bias Current Clock Feedthrough

The HTC6X33 use switching on the inputs to correct for the intrinsic offset and drift of the amplifier. Charge injection from the integrated switches on the inputs can introduce very short transients in the input bias current of the amplifier. The extremely short duration of these pulses prevents the device from being amplified. However, the devices may be coupled to the output of the amplifier through the feedback network. The most effective method to prevent transients in the input bias current from producing additional noise at the amplifier output is to use a low-pass filter such as an RC network.



High-Precision, Rail-to-Rail I/O Operational Amplifier

Application Notes

Layout Guidelines

For best operational performance of the device, use good printed circuit board (PCB) layout practices, including:

- Place the external components as close to the device as possible. This configuration prevents parasitic errors (such as the Seebeck effect) from occurring.
- To reduce parasitic coupling, run the input traces as far away from the supply lines and digital signal as possible.
- Low-ESR, 0.1- μ F ceramic bypass capacitors must be connected between each supply pin and ground, placed as close to the device as possible. A single bypass capacitor from V+ to ground is applicable to single supply applications.
- Consider a driven, low-impedance guard ring around the critical traces. A guard ring can significantly reduce leakage currents from nearby traces that are at different potentials.

Low-side Current Monitor

Figure 4 shows the HTC6X33 configured in a low-side current-sensing application. The load current (I_{LOAD}) creates a voltage drop across the shunt resistor (R_{SHUNT}). This voltage is amplified by the HTC6X33.

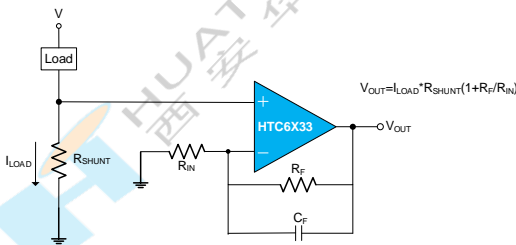

Figure 3. Low-Side Current Monitor

Bridge Amplifier

Figure 5 shows the basic configuration for a bridge amplifier.

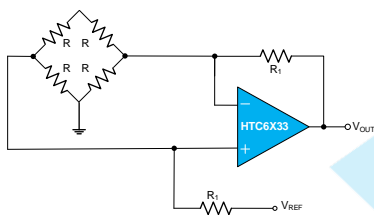

Figure 4. Bridge Amplifier

Programmable Power Supply

Figure 6 shows the HTC6X33 configured as a precision programmable power supply using DAC and power amplifier. The HTC6X33 in the front-end provides precision and low drift across a wide range of inputs and conditions.

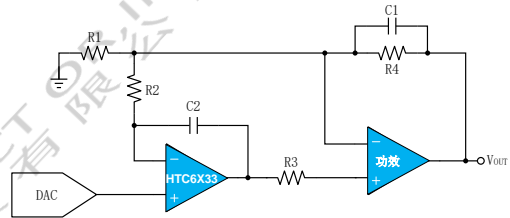
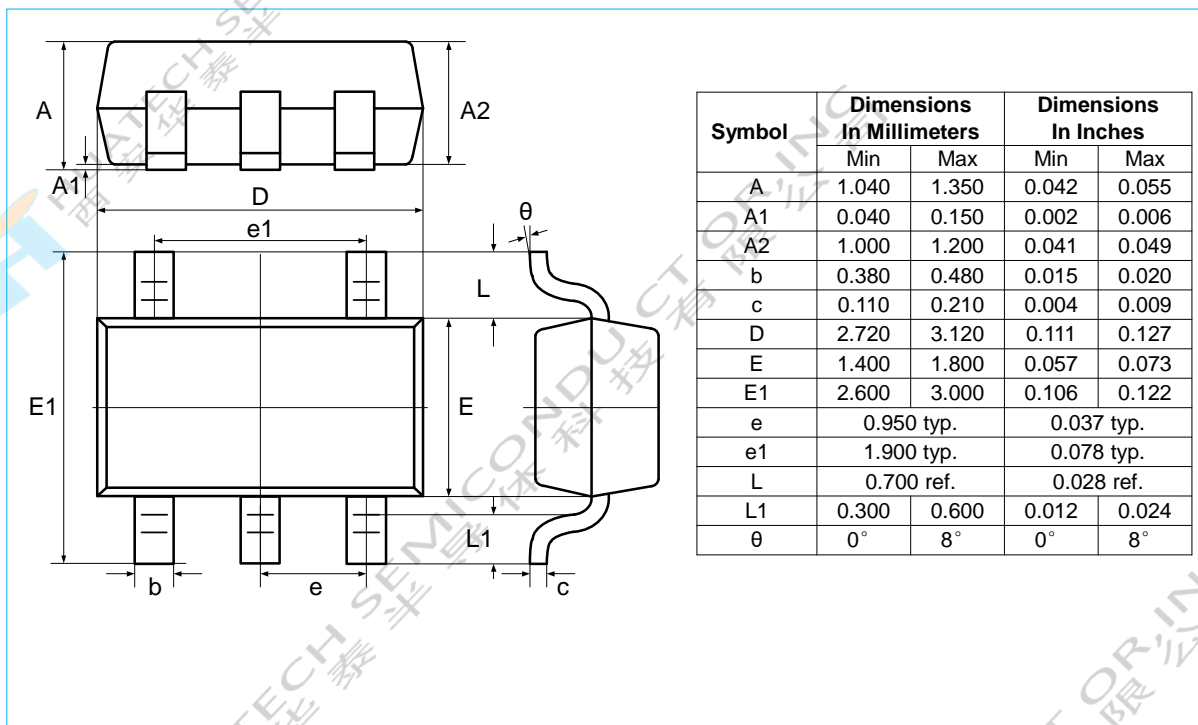

Figure 5. Programmable Power Supply



Package Outlines

SC70-7/SOT23-5



MSOP-8

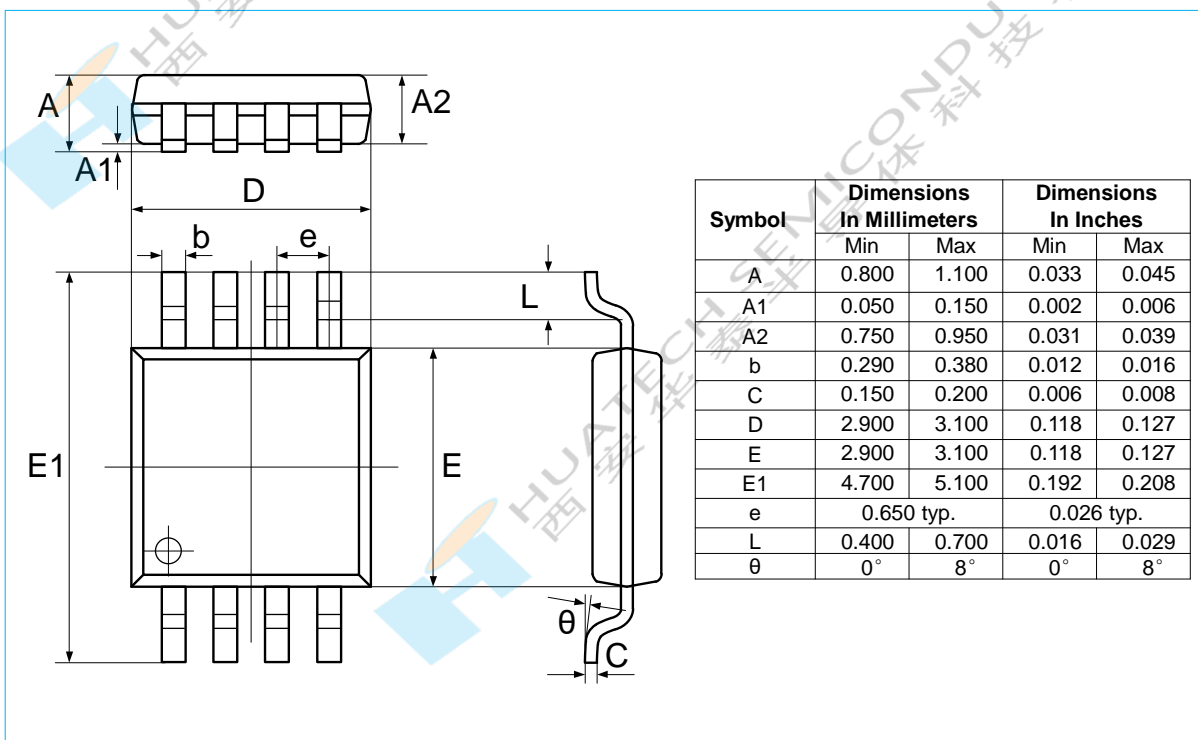



High-Precision, Low-Noise, Rail-to-Rail Output, 45-V, Zero-Drift Operational Amplifier

Package Outlines

SOP-8

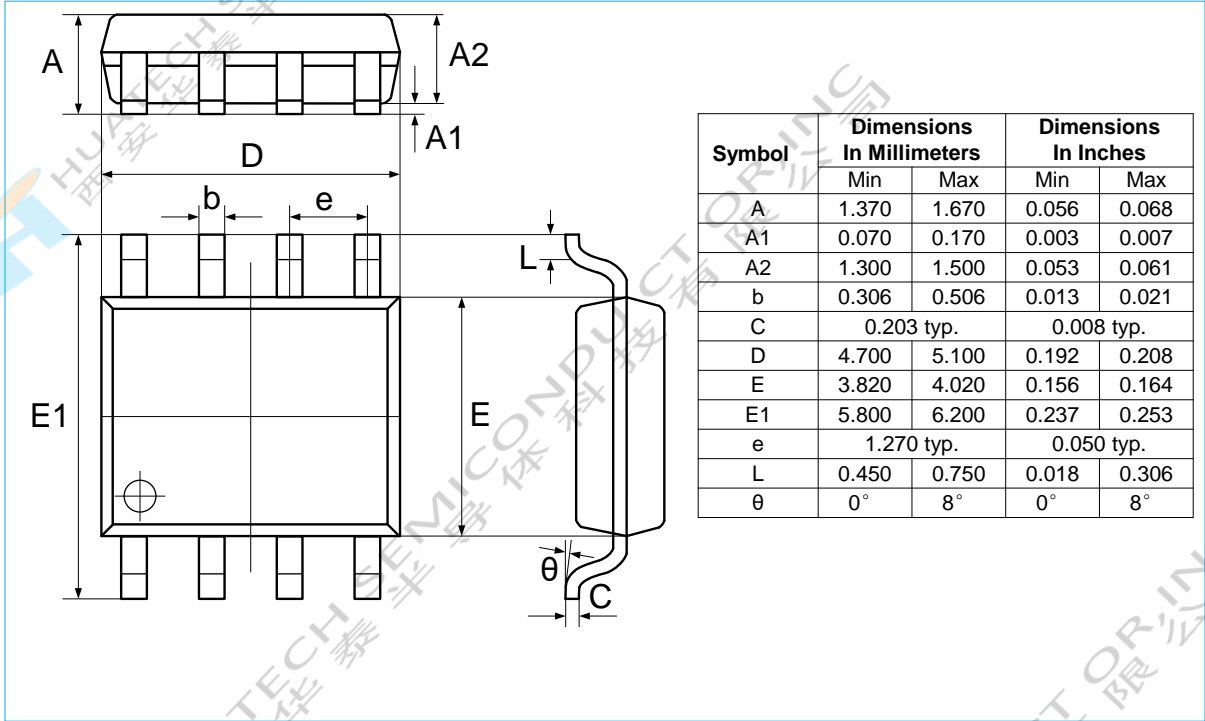

Important Notice

Huatech Semiconductor Inc and its subsidiaries (Huatech) reserve the right to make corrections, enhancement, amelioration or other changes for them. Buyers should obtain the latest relevant information before placing orders and should verify that such information is current and complete. This condition is also applied to the process of sales contract.

Huatech promises that functions of its products match the scope of application described in the product datasheet, Huatech promises that functions of its products match the scope of application described in the product datasheet, and performs strict tests for all parameters to guarantee the quality of products.