

MAPX	MODIFICATION	DATE
------	--------------	------

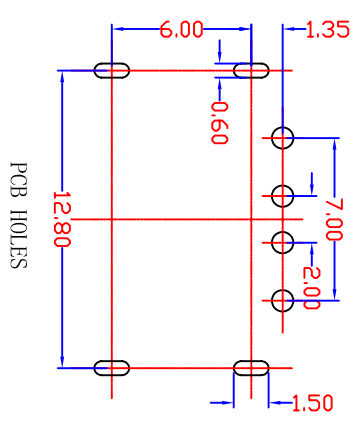
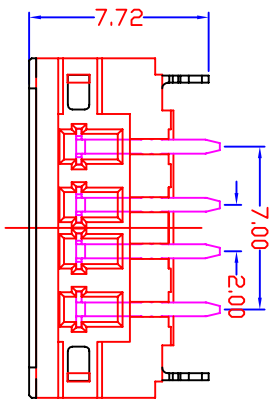
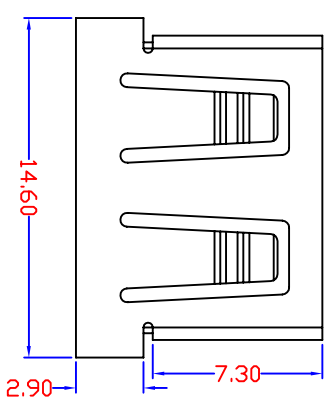
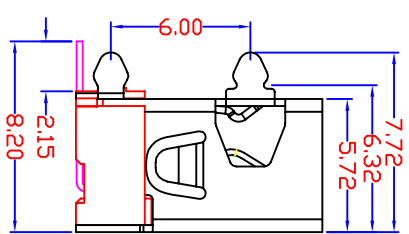
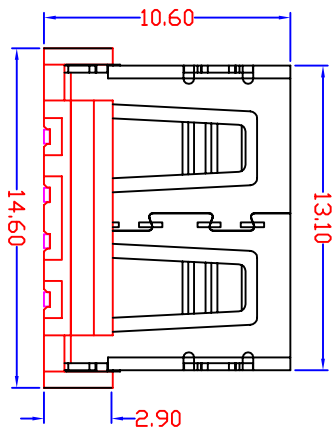
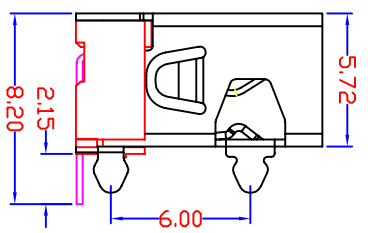
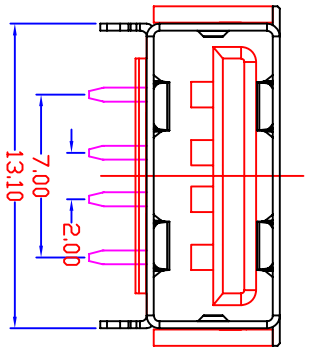

Specification:
1. Electrical Characteristics:
 Dielectric Withstanding Voltage AC: 500V/1MINUTE.
 Insulation Resistance 1000 MΩ/Min.
 Contact Resistance 30 mΩ Max.
2. Mechanical Characteristics:
 INSERTION FORCE: 3.0N(3.06kgf) MAX
 EXTRACTION FORCE: 10~3.0N(1.02~3.06kgf)
 Durability: 1500cycles EXTRACTION FORCE: 10~3.0N(1.02~3.06kgf)
3. Material:
 Terminal: Phosphor Bronze, C5191R-H T=0.25
 Plating: Gold 0.76 um Min plating over 1.27 um Min Nickel underplate, 2.54 um Min Sn selective plating on solder tail;
 Shell: Phosphor Bronze, C2680R-H T=0.30mm
 Plating: Nickel underplate 2.54 um Min;
 Housing: PBT ; UL94V-0
4. Environmental:
 Operating Temperature: 0 °C to +85 °C.

产品图
PRODUCT CHART DWG

深圳市精拓金电子有限公司

公差一览表		单位	MM	制图	Z-Y-B	制图料号	
TOLERANCE UNLESS OTHERWISE		UNITS		DRAWING		PRODUCT PART NO.	
X	±0.15	X	±5.°	比例	1:1	产品名称	USB A/F 90° SMT 短体
X	±0.10	X	±2.°	SCALE		PRODUCT NO.	
XX	±0.05	XX	±1.°	日期	20110902	角法	
XXX	±0.03	XXX	±0.5°	DATE		VER	版本
				APPD			AD