

SMD ■ B

19-226/R6GHC-A03/2T



Features

- Package in 8mm tape on 7" diameter reel.
- Compatible with automatic placement equipment.
- Compatible with infrared and vapor phase reflow solder process.
- Mono-color type.
- Pb-free.
- The product itself will remain within RoHS compliant version.
- Compliance with EU REACH
- Compliance Halogen Free .(Br <900 ppm ,Cl <900 ppm , Br+Cl < 1500 ppm).

Description

- The 19-226 SMD LED is much smaller than lead frame type components, thus enable smaller board size, higher packing density, reduced storage space and finally smaller equipment to be obtained.
- Besides, lightweight makes them ideal for miniature applications. etc.

Applications

- Backlighting in dashboard and switch.
- Telecommunication: indicator and backlighting in telephone and fax.
- Flat backlight for LCD, switch and symbol.
- General use.

Device Selection Guide

Code	Chip Materials	Emitted Color	Resin Color
R6	AlGaInP	Brilliant Red	Water Clear
GH	InGaN	Brilliant Green	

Absolute Maximum Ratings (Ta=25°C)

Parameter	Symbol	Code	Rating	Unit
Reverse Voltage	V_R		5	V
Forward Current	I_F	R6	25	mA
		GH	25	
Peak Forward Current (Duty 1/10 @1KHz)	I_{FP}	R6	60	mA
		GH	100	
Power Dissipation	P_d	R6	60	mW
		GH	95	
Electrostatic Discharge	ESD_{HBM}	R6	2000	V
		GH	150	
Operating Temperature	T_{opr}		-40 ~ +85	°C
Storage Temperature	T_{stg}		-40 ~ +90	°C
Soldering Temperature	T_{sol}		Reflow Soldering : 260 °C for 10 sec. Hand Soldering : 350 °C for 3 sec.	

Electro-Optical Characteristics (Ta=25°C)

Parameter	Symbol	Code	Min.	Typ.	Max.	Unit	Condition
Luminous Intensity	I _v	R6	72.0	-----	140	mcd	
		GH	112	-----	285		
Viewing Angle	2θ _{1/2}		-----	120	-----	deg	
Peak Wavelength	λ _p	R6	-----	632	-----	nm	
		GH	-----	518	-----		
Dominant Wavelength	λ _d	R6	615	-----	625	nm	I _F =20mA
		GH	520	-----	530		
Spectrum Radiation Bandwidth	Δλ	R6	-----	20	-----	nm	
		GH	-----	35	-----		
Forward Voltage	V _F	R6	1.7	2.0	2.4	V	
		GH	2.7	3.3	3.7		
Reverse Current	I _R	R6	-----	-----	10	μA	V _R =5V
		GH	-----	-----	50		

Note:

1. Tolerance of Luminous Intensity: ±11%
2. Tolerance of Dominant Wavelength ±1nm
3. Tolerance of Forward Voltage ±0.1V

R6

Bin Range of Luminous Intensity

Bin Code	Min.	Max.	Unit	Condition
Q1	72	90	mcd	I _F =20mA
Q2	90	112		
R1	112	140		

Bin Range of Dom. Wavelength

Bin Code	Min.	Max.	Unit	Condition
1	615	620	nm	I _F =20mA
2	620	625		

GH

Bin Range of Luminous Intensity

Bin Code	Min.	Max.	Unit	Condition
R1	112	140	mcd	I _F =20mA
R2	140	180		
S1	180	225		
S2	225	285		

Bin Range of Dom. Wavelength

Bin Code	Min.	Max.	Unit	Condition
1	520	525	nm	I _F =20mA
2	525	530		

Note:

1. Tolerance of Luminous Intensity: ±11%
2. Tolerance of Dominant Wavelength ±1nm

Typical Electro-Optical Characteristics Curves

R6

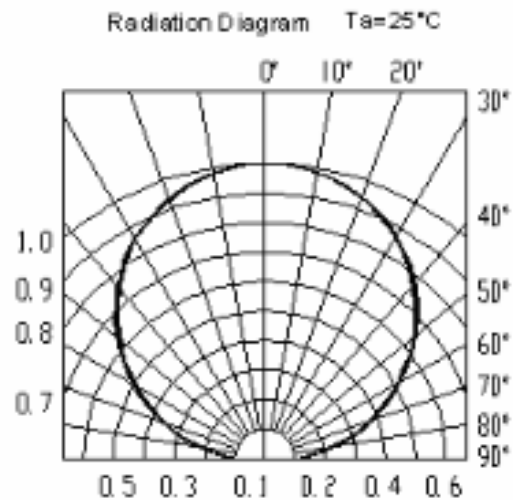
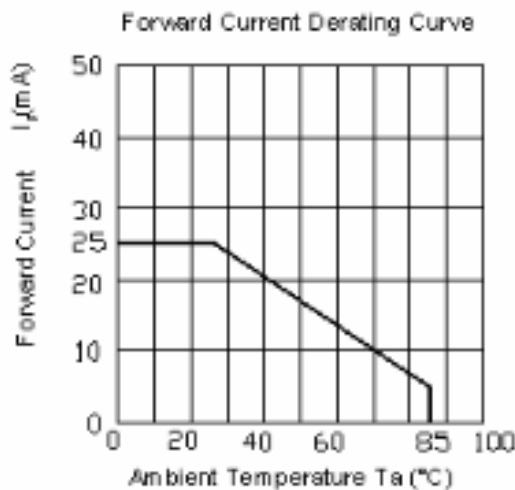
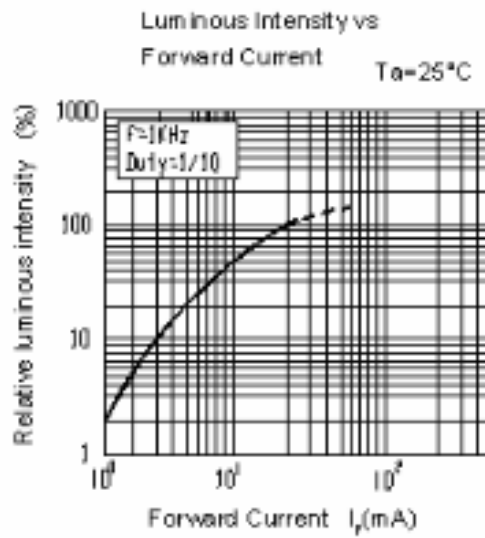
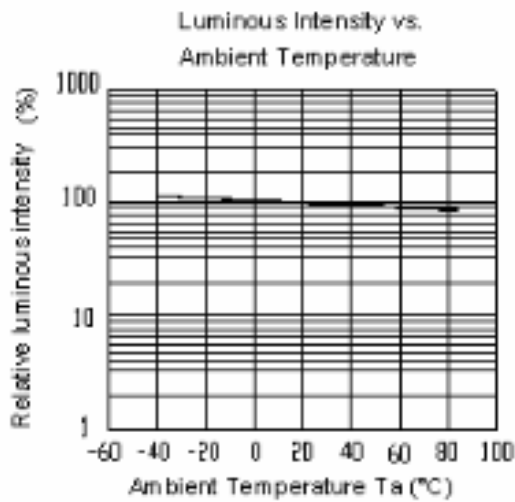
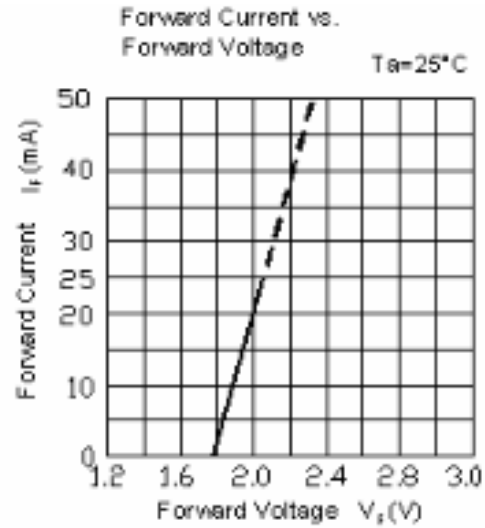
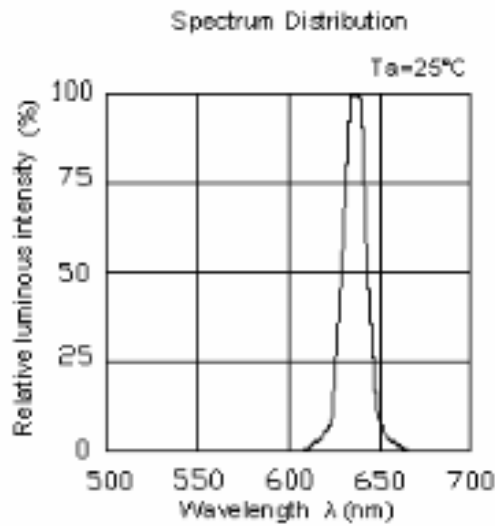

Typical Electro-Optical Characteristics Curves

GH

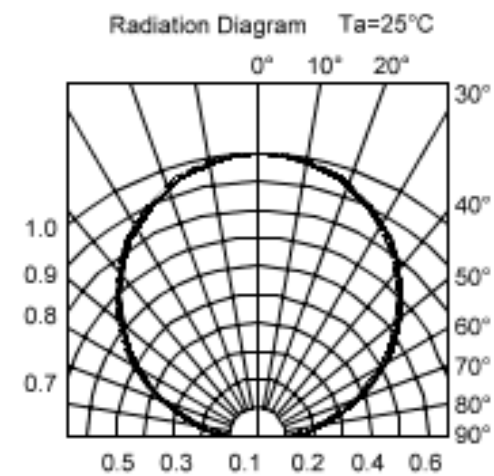
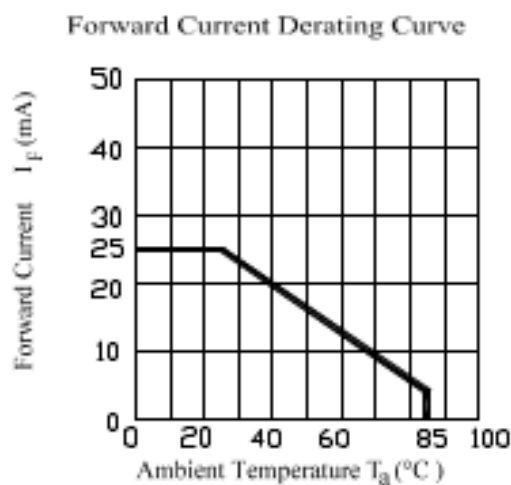
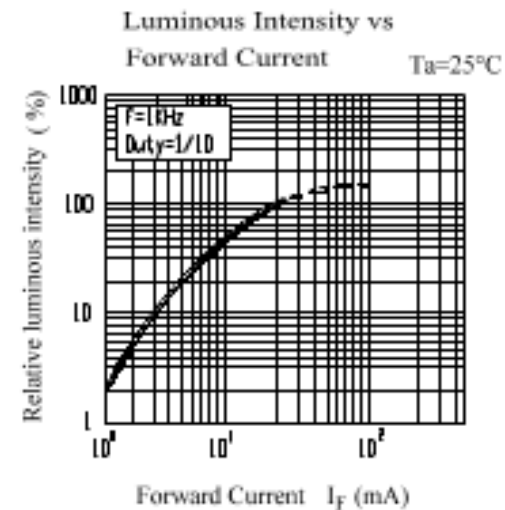
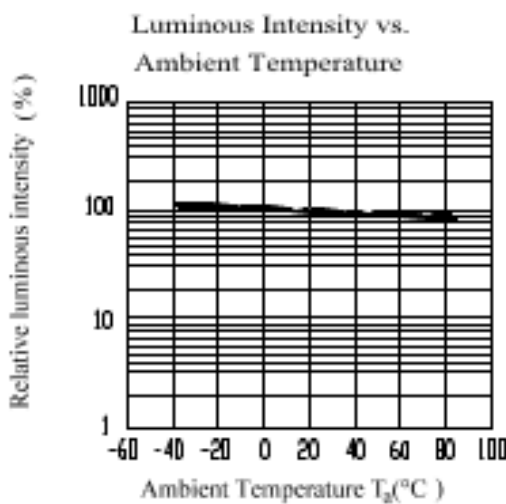
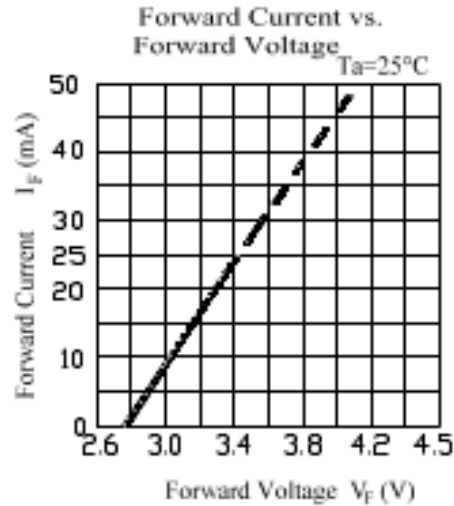
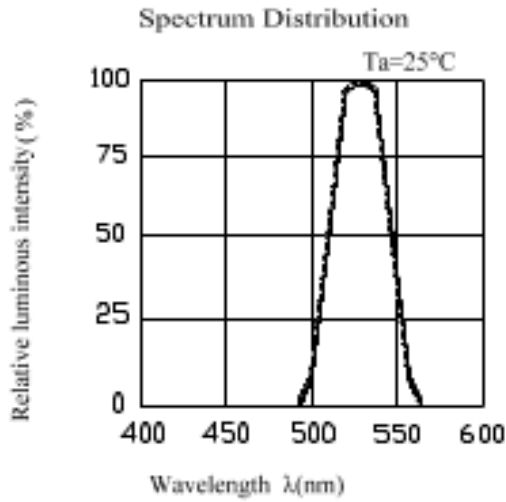

Package Dimension

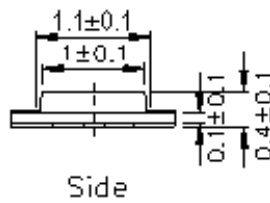
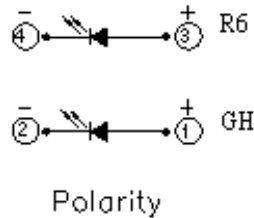
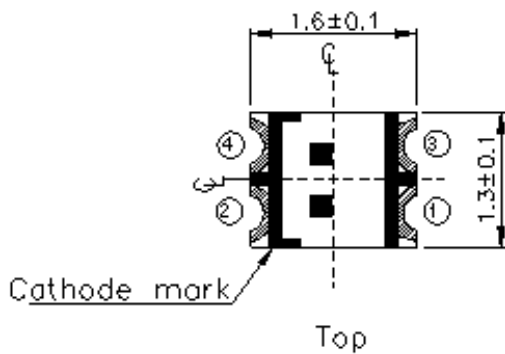

Recommend soldering pad

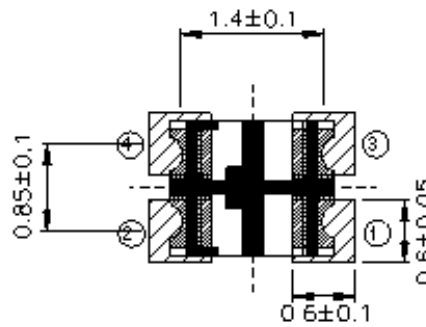
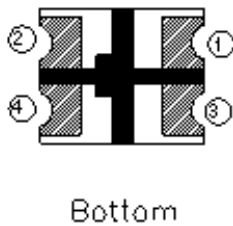

Suggested pad dimension is just for reference only.
Please modify the pad dimension based on individual need.

Note: Tolerances unless mentioned ± 0.1 mm. Unit = mm

**Moisture Resistant Packing Materials
 Label Explanation**



- CPN: Customer's Product Number
- P/N: Product Number
- QTY: Packing Quantity
- CAT: Luminous Intensity Rank
- HUE: Chromaticity Coordinates & Dom. Wavelength Rank
- REF: Forward Voltage Rank
- LOT No: Lot Number

Reel Dimensions

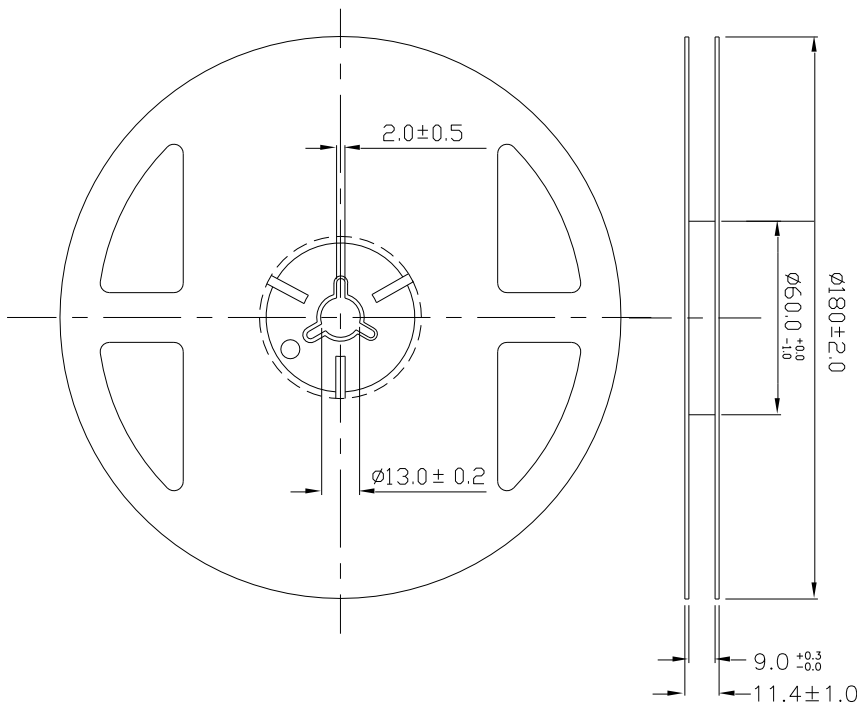

Note: The tolerances unless mentioned is ± 0.1 mm ,Unit = mm

Carrier Tape Dimensions: Loaded quantity 2000 PCS per reel

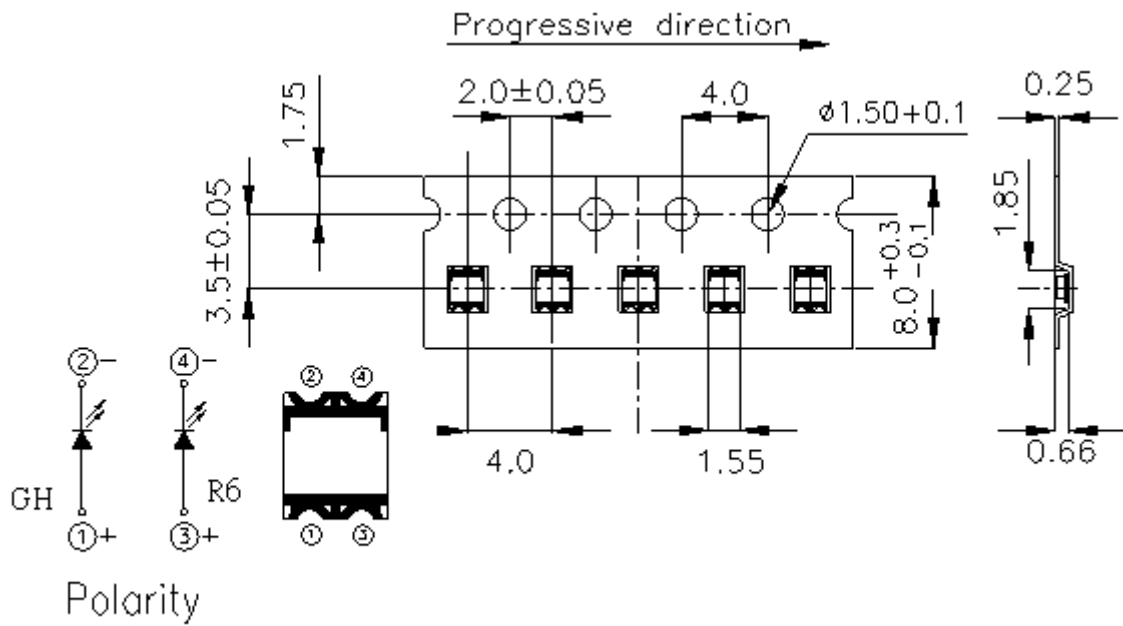

Note: The tolerances unless mentioned is $\pm 0.1\text{mm}$, Unit = mm

Moisture Resistant Packaging

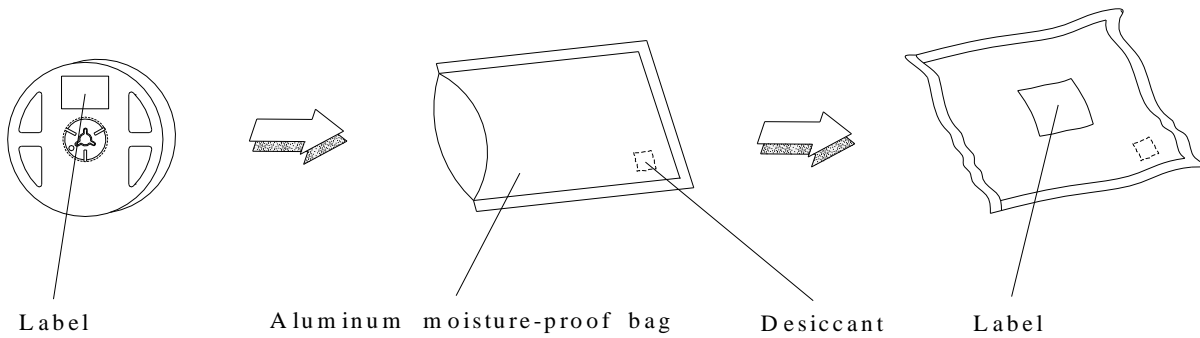

Precautions For Use

1. Over-current-proof

Customer must apply resistors for protection, otherwise slight voltage shift will cause big current change (Burn out will happen).

2. Storage

2.1 Do not open moisture proof bag before the products are ready to use.

2.2 After opening the package: The LEDs should be kept at 30°C or less and 60%RH or less.

2.3 The LEDs should be used within 168 hours (7days) after opening the package .

If unused LEDs remain, it should be stored in moisture proof packages.

2.4 If the moisture absorbent material (silica gel) has faded away or the LEDs have exceeded the storage time, baking treatment should be performed using the following conditions.

Baking treatment : 60±5°C for 24 hours.

3. Soldering Condition

3.1 Pb-free solder temperature profile

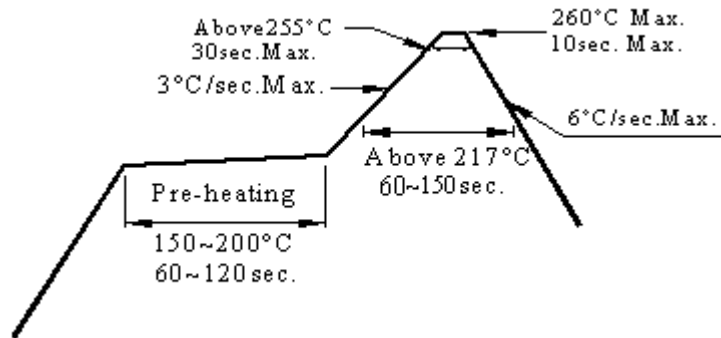

3.2 Reflow soldering should not be done more than two times.

3.3 When soldering, do not put stress on the LEDs during heating.

3.4 After soldering, do not warp the circuit board.

4. Soldering Iron

Each terminal is to go to the tip of soldering iron temperature less than 350°C for 3 seconds within once in less than the soldering iron capacity 25W. Leave two seconds and more intervals, and do soldering of each terminal. Be careful because the damage of the product is often started at the time of the hand solder.

5. Repairing

Repair should not be done after the LEDs have been soldered. When repairing is unavoidable, a double-head soldering iron should be used (as below figure). It should be confirmed beforehand whether the characteristics of the LEDs will or will not be damaged by repairing.

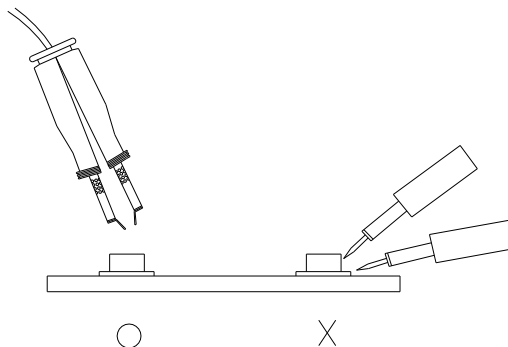

Application Restrictions

High reliability applications such as military/aerospace, automotive safety/security systems, and medical equipment may require different product. If you have any concerns, please contact Everlight before using this product in your application. This specification guarantees the quality and performance of the product as an individual component. Do not use this product beyond the specification described in this document.