

# 1.0mm PITCH FPC CONNECTORS

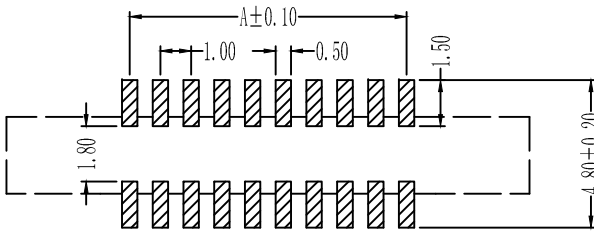
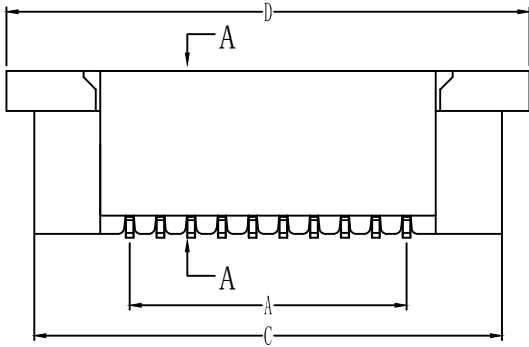
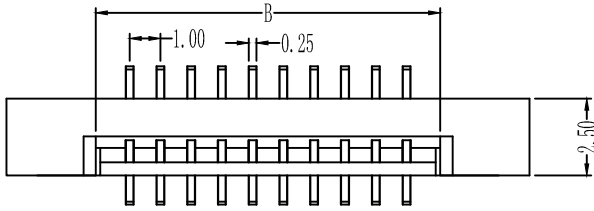

PCB Layout

性能:

额定电流: 0.5A  
 额定电压: 50V  
 耐电压: 500V  
 接触电阻:  $\leq 20m\Omega$   
 绝缘电阻:  $800M\Omega$   
 工作温度:  $-20^{\circ}C \sim +85^{\circ}C$

塑件 (材质): LCP, UL94V-0  
 锁扣 (材质): PA46, UL94V-0  
 插簧 (材质): 磷青铜, 镀锡/镀金

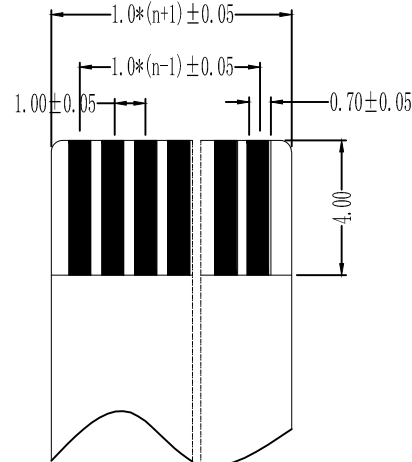
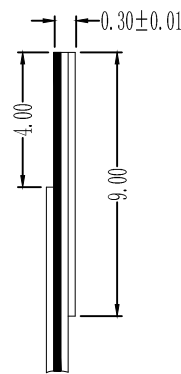
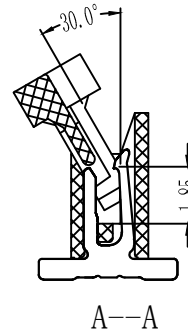
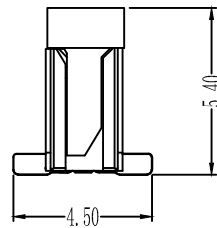

适用扁平电缆

孔位	A	B	C	D
2	1	3.2	7.2	9
3	2	4.2	8.2	10
4	3	5.2	9.2	11
5	4	6.2	10.2	12
6	5	7.2	11.2	13
7	6	8.2	12.2	14
8	7	9.2	13.2	15
9	8	10.2	14.2	16
10	9	11.2	15.2	17
11	10	12.2	16.2	18
12	11	13.2	17.2	19
13	12	14.2	18.2	20
14	13	15.2	19.2	21
15	14	16.2	20.2	22
16	15	17.2	21.2	23
17	16	18.2	22.2	24
18	17	19.2	23.2	25
19	18	20.2	24.2	26
20	19	21.2	25.2	27
21	20	22.2	26.2	28
22	21	23.2	27.2	29
23	22	24.2	28.2	30
24	23	25.2	29.2	31
25	24	26.2	30.2	32
26	25	27.2	31.2	33
27	26	28.2	32.2	34
28	27	29.2	33.2	35
29	28	30.2	34.2	36
30	29	31.2	35.2	37

X. ± 0.3	X.° ± 5°	UNITS	mm	NAME (INTENDED USE)	<b>MSTCONN</b> SHEN ZHEN DE RUI ELECTRONIC CO., LTD	
.X ± 0.25	.X° ± 2°	MAT'L		1.0mm FPC (G型) 立贴式 (无焊片)		
.XX ± 0.20	.XX° ± 1°	FINISH		PART NO. (INTENDED USE)	TITLE:	
.XXX ± 0.10	.XXX° ± 0.5°			1.0K-GT-nPB	1.0mm FPC (G型) 立贴式 (无焊片)	
THESE DRAWINGS AND SPECIFICATIONS ARE THE PROPERTY OF DE RUI ELECTRONIC FACTORY AND SHALL NOT BE REPRODUCED, COPIED OR USED IN ANY MANNER WITHOUT THE PRIOR WRITTEN CONSENT OF DE RUI ELECTRONIC FACTORY				APPD:	DWG NO.:	
				Q' TY	100K17-GUB0000000	
				CHKD:		
DR:	YLZ 2011.09.28			SCALE	SHEET	REV.
				1/1	1/1	A