

PRODUCT NO.	DSIC09THGET
RoHS compliant	

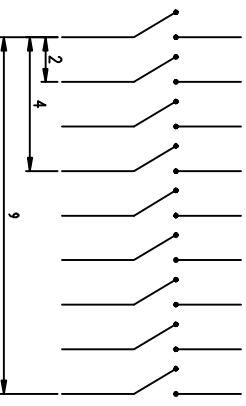

- NOTES :
- 1> Specification:
    - 1> Operating force: 1000gf Max
    - 2> Operating Temperature: -40° to +85°
    - 3> Storage Temperature: -40° to +85°
    - 4> Mechanical Life: 3000cycles minimum
    - 5> Electrical Life: 2000cycles 25mA 24VDC
  2. PLATING:
    - GOLD FLASH 1u"(min.) SOLDER TAIL,
    - 3u" GOLD PLATING ON THE CONTACT AREA,
    - WITH 50u" NICKEL UNDERPLATING OVERALL.

3. PART NUMBER DESCRIPTION

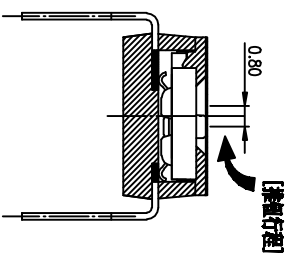
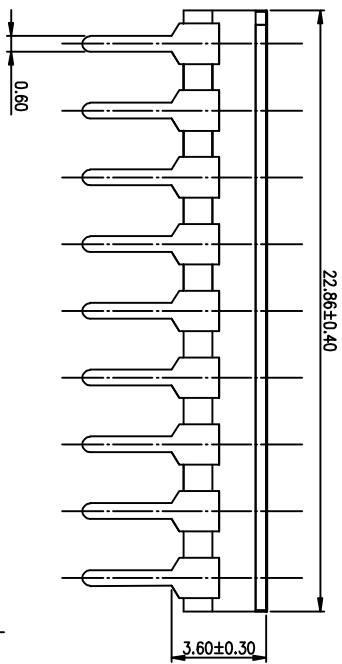
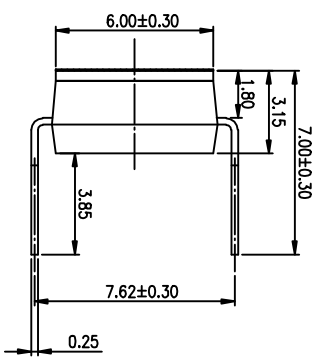
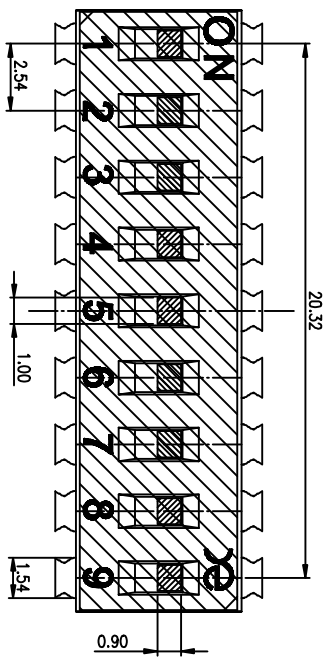
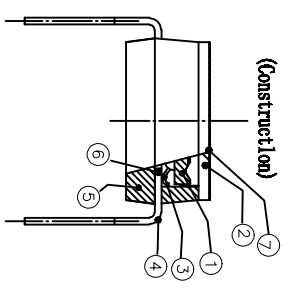
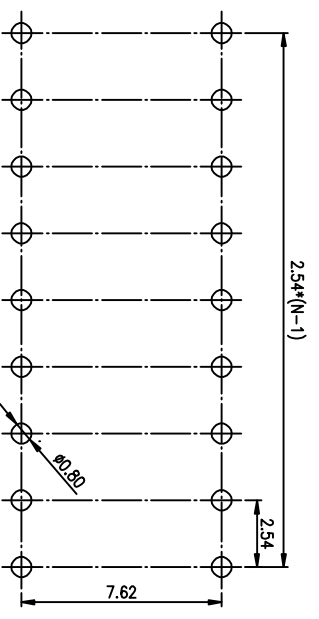
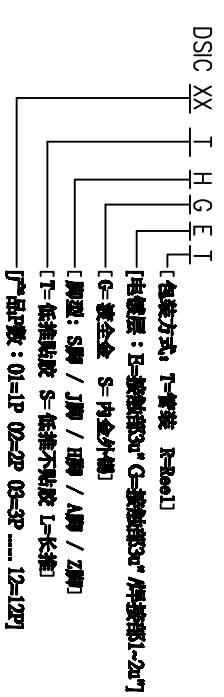

Number	Part Name	Material	Finished
①	Actuator	UL94 VO	White
②	Cover	UL94 VO	Black
③	Movable	Copper Alloy	3u"Gold
④	Terminal	Brass	1u"Gold
⑤	Base	UL94 VO	Black
⑥	Terminal Contact	Brass	3u"Gold
⑦	Mylar	UL94 VO	0.05mm

TOLERANCE UNLESS OTHERWISE SPECIFIED		INSPECTION COPY	
LINER	ANGLES	PROJECTION	COPY
0 ± 0.25	0 ± 2'		BY DSIC SERIES PITCH 2.54mm
.00 ± 0.15	.0 ± 1'		
.000 ± 0.10	.00 ± 0.5'	DESIGN	2012/04/12
DRAWING		PRAT NO.	DSIC09THGET
CHECK		FILE NO.	DSIC09THGET-A
APPRO.		SIZE	UNIT SCALE SHEET REV.
		A4	mim 2 : 1 1 OF 1 A

**RE** 东莞市 睿康实业有限公司  
Dongguan Kingtek Industrial Co., Ltd.