



Application Note: SY8088I

High Efficiency, 1.5MHz, 1A Synchronous Step Down Regulator Preliminary Specification

General Description

SY8088I is a high efficiency 1.5MHz synchronous step down DC/DC regulator capable of delivering up to 1A output current. It can operate over a wide input voltage range from 2.5V to 5.5V and integrates main switch and synchronous switch with very low $R_{DS(ON)}$ to minimize the conduction loss.

The low output voltage ripple, the small external inductor and the capacitor sizes are achieved with 1.5MHz switching frequency.

Ordering Information

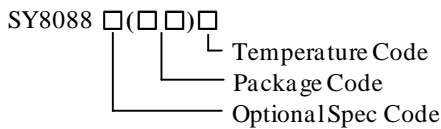

Ordering Number	Package type	Note
SY8088IAAC	SOT23-5	--

Features

- 2.5V to 5.5V Input Voltage Range
- 50 μ A Low Quiescent Current
- Low $R_{DS(ON)}$ for Internal Switches (Top/Bottom) 270m Ω /160m Ω
- High Switching Frequency 1.5MHz Minimizes the External Components
- Internal Soft-start Limits the Inrush Current
- 100% Dropout Operation
- Reliable Short Circuit Protection
- RoHS Compliant and Halogen Free
- Output Auto Discharge Function
- Compact Package: SOT23-5

Applications

- Set Top Box
- USB Dongle
- Media Player
- Smart phone

Typical Applications

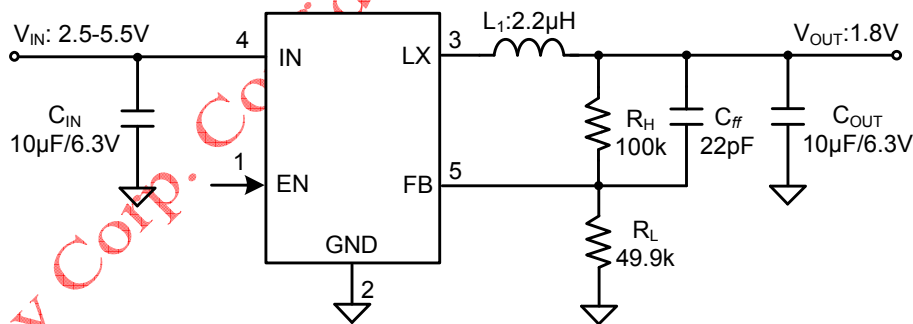
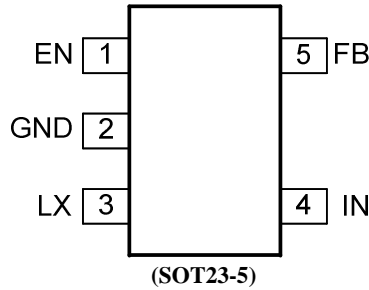

Figure1. Schematic Diagram

Pinout (Top View)



Top Mark: bPxyz (device code: bP, x=year code, y=week code, z=lot number code)

Pin Name	Pin Number	Pin Description
EN	1	Enable control. Pull high to turn on. Do not leave it floating.
GND	2	Ground pin.
LX	3	Inductor pin. Connect this pin to the switching node of the inductor.
IN	4	Input pin. Decouple this pin to the GND pin with at least a 10μF ceramic capacitor.
FB	5	Output feedback pin. Connect this pin to the center point of the output resistor divider (as shown in Figure 1) to program the output voltage: $V_{OUT}=0.6 \times (1+R_H/R_L)$.

Block Diagram

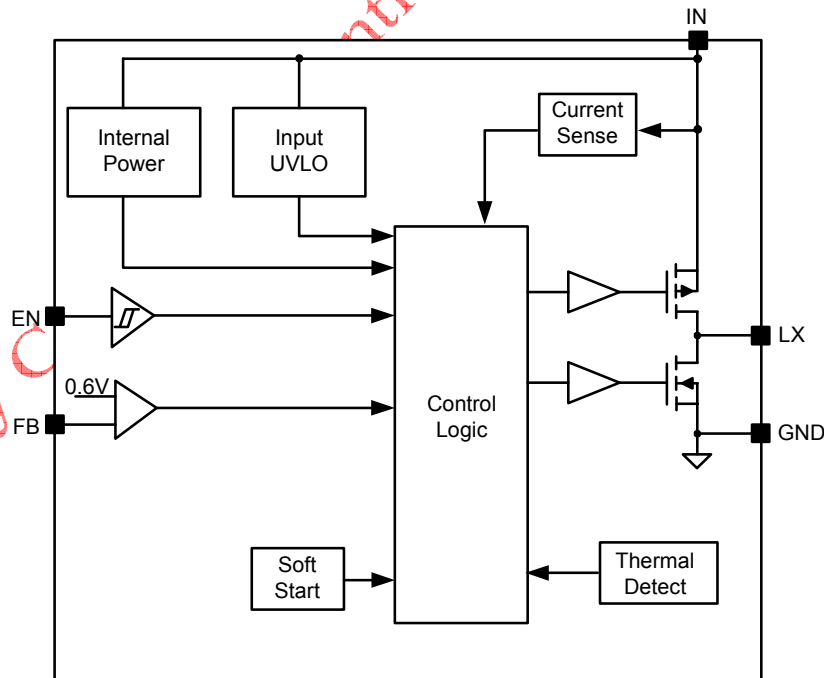

Figure2. Block Diagram



Absolute Maximum Ratings (Note 1)

Supply Input Voltage	6.0V
EN, FB Voltage	V _{IN} + 0.6V
LX Voltage	-0.3V ^(*) to 6.0V ^(**)
Power Dissipation, P _D @ T _A = 25°C	0.77W
Package Thermal Resistance (Note 2)	
θ _{JA}	130°C/W
θ _{JC}	28°C/W
Junction Temperature Range	-40°C to 150°C
Lead Temperature (Soldering, 10 sec.)	260°C
Storage Temperature Range	-65°C to 150°C
^(*) LX voltage tested down to -3V<40ns	
^(**) LX voltage tested up to +7V<40ns	

Recommended Operating Conditions (Note 3)

Supply Input Voltage	2.5V to 5.5V
Junction Temperature Range	-40°C to 125°C
Ambient Temperature Range	-40°C to 85°C



Electrical Characteristics

($V_{IN} = 5V$, $V_{OUT} = 1.8V$, $L = 2.2\mu H$, $C_{OUT} = 10\mu F$, $T_A = 25^\circ C$, unless otherwise specified)

Parameter	Symbol	Test Conditions	Min	Typ	Max	Unit
Input Voltage Range	V_{IN}		2.5		5.5	V
Input UVLO Threshold	V_{UVLO}				2.45	V
Input UVLO Hysteresis	V_{HYS}			150		mV
Quiescent Current	I_Q	$V_{FB} = V_{REF} \times 105\%$		50	70	μA
Shutdown Current	I_{SHDN}	$V_{EN} = 0V$		0.1	1	μA
Feedback Reference Voltage	V_{REF}	$I_{OUT} = 0.5A$, CCM	591	600	609	mV
LX Node Discharge Resistance	R_{DIS}			50		Ω
Top FET R_{ON}	$R_{DS(ON)1}$			260		m Ω
Bottom FET R_{ON}	$R_{DS(ON)2}$			170		m Ω
EN Input Voltage High	$V_{EN,H}$		1.2			V
EN Input Voltage Low	$V_{EN,L}$				0.4	V
Min ON Time	$t_{ON,MIN}$			60		ns
Maximum Duty Cycle	D_{MAX}		100			%
Turn On Delay	$t_{ON,DLY}$	from EN high to LX start switching		300		μs
Soft-start Time	t_{SS}			700		us
Switching Frequency	f_{SW}	$I_{OUT} = 0.5A$, CCM		1.5		MHz
Top FET Current Limit	$I_{LMT, TOP}$		1.5		2.5	A
Thermal Shutdown Temperature	T_{SD}			160		$^\circ C$
Thermal Shutdown Hysteresis	T_{HYS}			20		$^\circ C$

Note 1: Stresses beyond the “Absolute Maximum Ratings” may cause permanent damage to the device. These are stress ratings only. Functional operation of the device at these or any other conditions beyond those indicated in the operational sections of the specification is not implied. Exposure to absolute maximum rating conditions for extended periods may affect device reliability.

Note 2: θ_{JA} of SY8088I is measured in the natural convection at $T_A = 25^\circ C$ on a 20Z two-layer Silergy evaluation board. Pin 3 is the case position for θ_{JC} measurement.

Note 3: The device is not guaranteed to function outside its operating conditions.



Typical Performance Characteristics

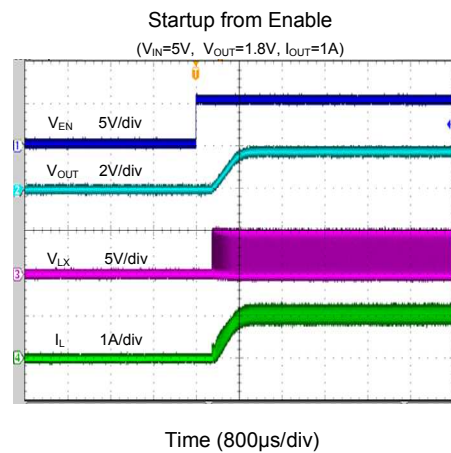
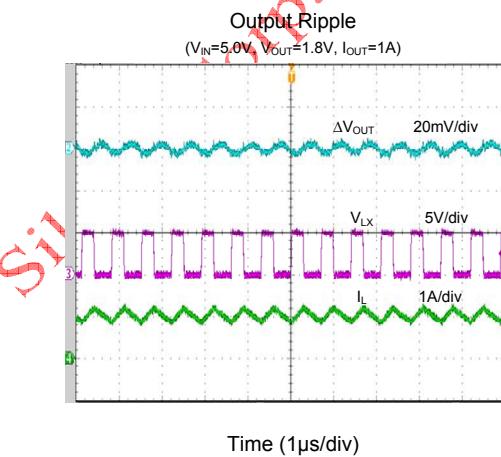
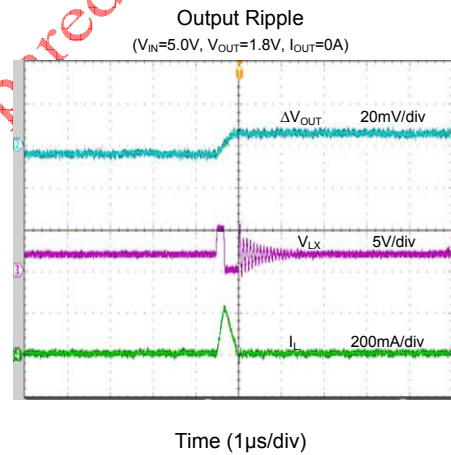
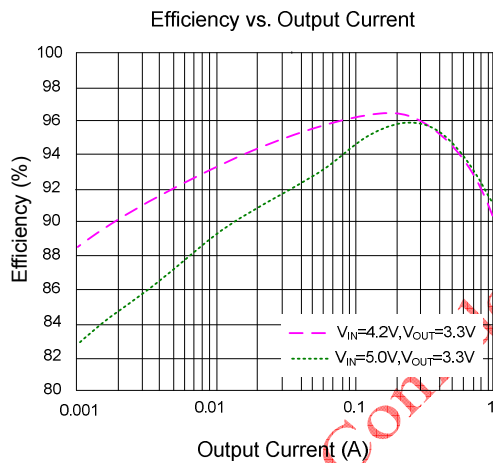
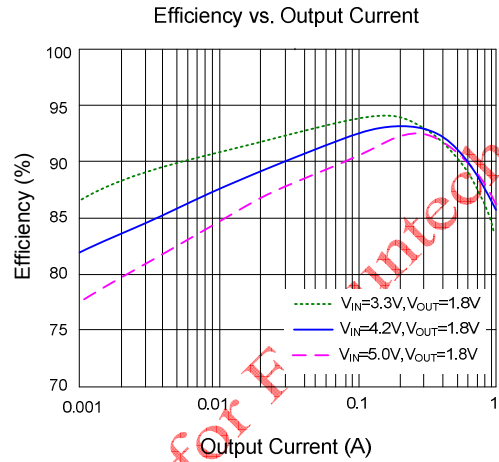
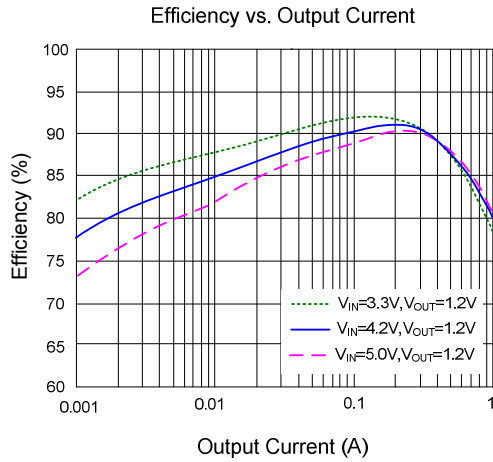

Shutdown from Enable

($V_{IN}=5V$, $V_{OUT}=1.8V$, $I_{OUT}=1A$)

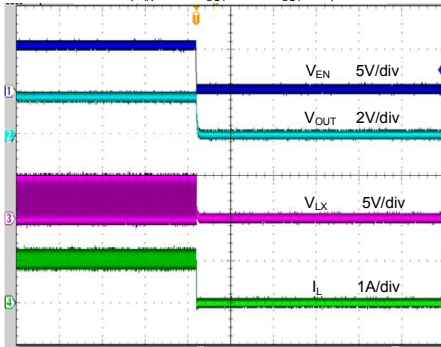

Time (800 μ s/div)

Load Transient

($V_{IN}=5V$, $V_{OUT}=1.8V$, $I_{OUT}=0A$ to $0.5A$)

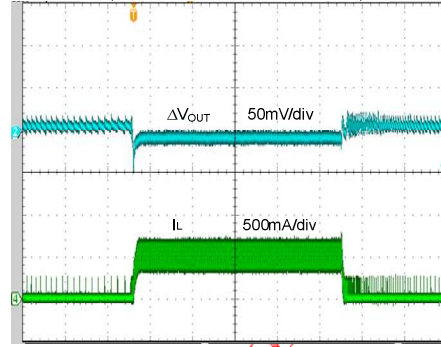

Time (200 μ s/div)

Load Transient

($V_{IN}=5V$, $V_{OUT}=1.8V$, $I_{OUT}=0.1A$ to $1A$)

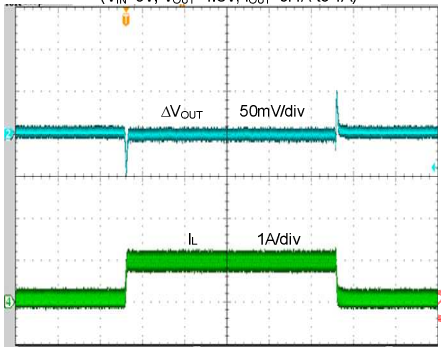

Time (200 μ s/div)

Short Circuit Protection

($V_{IN}=5V$, $V_{OUT}=1.8V$, $I_{OUT}=0A$ to short to $0A$)

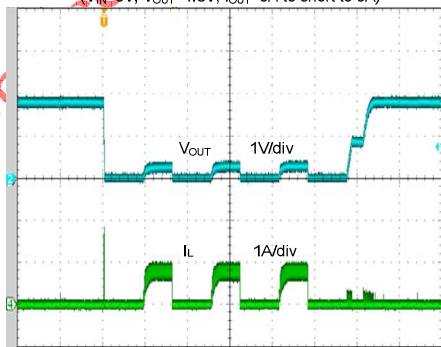

Time (2ms/div)

Short Circuit Protection

($V_{IN}=5V$, $V_{OUT}=1.8V$, $I_{OUT}=1A$ to short to $1A$)

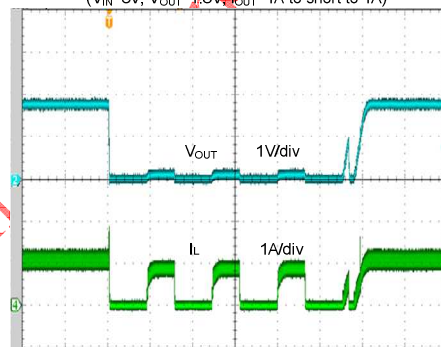

Time (2ms/div)



Operation

SY8088I is a high efficiency 1.5MHz synchronous step down DC/DC regulator capable of delivering up to 1A output current. It can operate over a wide input voltage range from 2.5V to 5.5V and integrates main switch and synchronous switch with very low $R_{DS(ON)}$ to minimize the conduction loss.

The low output voltage ripple, the small external inductor and the capacitor sizes are achieved with 1.5MHz switching frequency.

Applications Information

Because of the high integration in the SY8088I, the application circuit based on this regulator is rather simple. Only input capacitor C_{IN} , output capacitor C_{OUT} , output inductor L , feedback resistors (R_H and R_L) and feed forward capacitor C_{ff} need to be selected for the targeted applications specifications.

Feedback Resistor Dividers R_H and R_L :

Choose R_H and R_L to program the proper output voltage. To minimize the power consumption under light loads, it is desirable to choose large resistance values for both R_H and R_L . A value of between 100k Ω and 1M Ω is highly recommended for both resistors. If $R_L=100k\Omega$ is chosen, then R_H can be calculated to be:

$$R_H = \frac{(V_{OUT} - 0.6V) \times R_L}{0.6V}$$

Input Capacitor C_{IN} :

A typical X5R or better grade ceramic capacitor with 6.3V rating and no less than 10 μ F capacitance is recommended. To minimize the potential noise problem, we place this ceramic capacitor really close to the IN and GND pins. Care should be taken to minimize the loop area formed by C_{IN} , and IN/GND pins.

Output Capacitor C_{OUT} :

The output capacitor is selected to handle the output ripple noise requirements. Both steady state ripple and transient requirements must be taken into consideration when selecting this capacitor. For the best performance, it is recommended to use X5R or better grade ceramic capacitor with 6.3V rating and no less than 10 μ F capacitance.

Output Inductor L :

There are several considerations in choosing this inductor.

- 1) Choose the inductance to provide the desired ripple current. It is suggested to choose the ripple current to be about 40% of the maximum output current. The inductance is calculated as:

$$L = \frac{V_{OUT}(1 - V_{OUT}/V_{IN,MAX})}{F_{SW} \times I_{OUT,MAX} \times 40\%}$$

Where F_{SW} is the switching frequency and $I_{OUT,MAX}$ is the maximum load current.

The SY8088I regulator IC is quite tolerant of different ripple current amplitude. Consequently, the final choice of inductance can be slightly off the calculation value without significantly impacting the performance.

- 2) The saturation current rating of the inductor must be selected to be greater than the peak inductor current under full load conditions.

$$I_{SAT,MIN} > I_{OUT,MAX} + \frac{V_{OUT}(1 - V_{OUT}/V_{IN,MAX})}{2 \cdot F_{SW} \cdot L}$$

- 3) The DCR of the inductor and the core loss at the switching frequency must be low enough to achieve the desired efficiency requirement. It is desirable to choose an inductor with DCR < 50m Ω to achieve a good overall efficiency.

Short Circuit Protection:

SY8088I integrates hic-cup mode hard short protection function. If output voltage is below 50% of the regulation voltage, the internal soft-start node and the error amplifier output will be reset immediately. IC works in hic-cup protection mode. The hiccup frequency is about 300Hz, and the hic-cup duty is about 45%. If the hard short condition is removed, IC will go back to normal operation.

Load Transient Considerations:

The SY8088I regulator integrates the compensation components to achieve good stability and fast transient responses. In some applications, adding a ceramic capacitor (feed-forward capacitor, C_{ff}) in parallel with R_H may further speed up the load transient responses and is thus recommended for applications with large load transient step requirements. Typically, for 1.2V/1.8V/3.3V output, the R_H , R_L , C_{ff} is recommended as below:

Table1. Recommended Component Selection

V_{OUT}	R_H	R_L	C_{ff}
1.2V	49.9k	49.9k	22pF
1.8V	100k	49.9k	22pF
3.3V	100k	22.1k	22pF

SOT23-5 Package Outline & PCB Layout Design

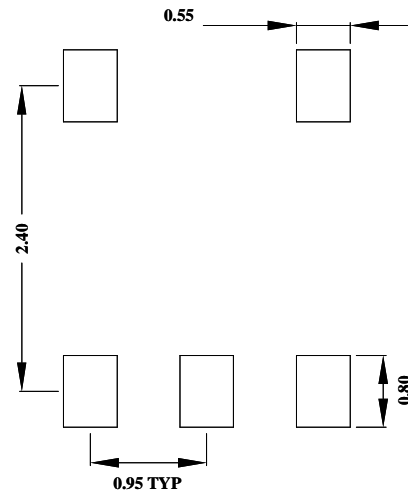
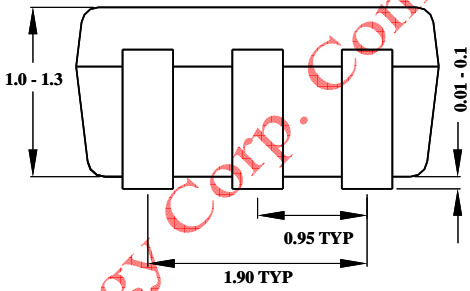
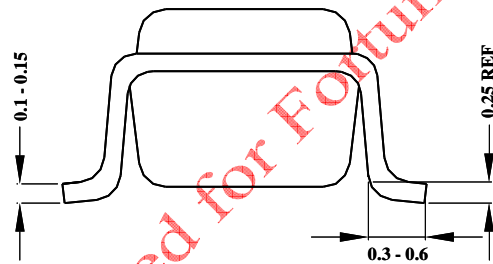
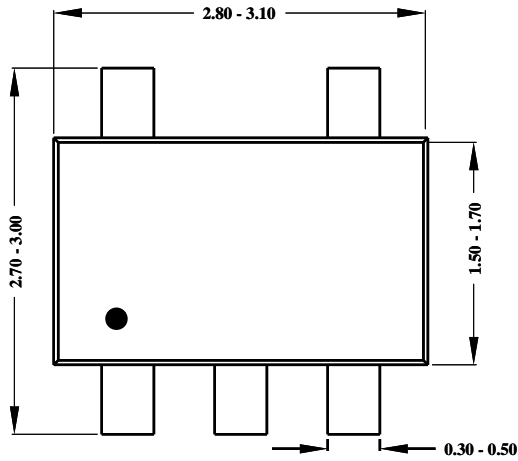

Recommended Pad Layout

Notes: All dimensions are in millimeters.
All dimensions don't include mold flash & metal burr.

Taping & Reel Specification

1. Taping orientation

SOT23-5

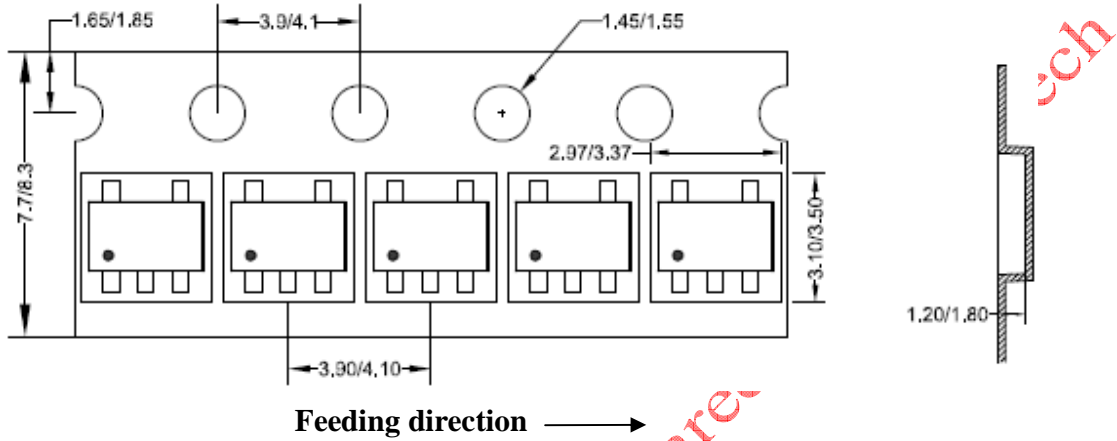

2. Carrier Tape & Reel specification for packages

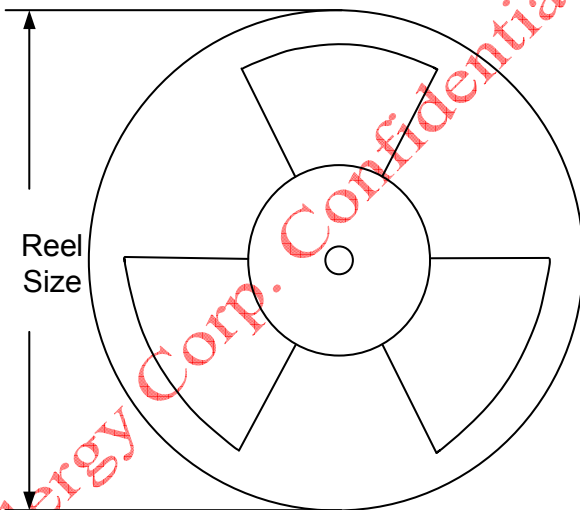

Package type	Tape width (mm)	Pocket pitch(mm)	Reel size (Inch)	Trailer length(mm)	Leader length (mm)	Qty per reel
SOT23-5	8	4	7"	280	160	3000

3. Others: NA