

20W AUDIO POWER AMPLIFIER

DESCRIPTION

The HG LM1875 is a monolithic power amplifier offering very low distortion and high quality performance for consumer audio applications.

The HG LM1875 delivers 20 watts into a 4 Ω or 8 Ω load on $\pm 25V$ supplies. Using an 8 Ω load and $\pm 30V$ supplies, over 30 watts of power may be delivered. The amplifier is designed to operate with a minimum of external components. Device overload protection consists of both internal current limit and thermal shutdown.

The HG LM1875 design takes advantage of advanced circuit techniques and processing to achieve extremely low distortion levels even at high output power levels. Other outstanding features include high gain, fast slew rate and a wide power bandwidth, large output voltage swing, high current capability, and a very wide supply range. The amplifier is internally compensated and stable for gains of 10 or greater.

FEATURES

- *Up to 30 watts output power
- *Avo typically 90 dB
- *Low distortion: 0.015%, 1kHz, 20W
- *Wide power bandwidth: 70kHz
- *Protection for AC and DC short circuits to ground
- *Thermal protection with thermal circuit
- *High current capability: 4A
- *Wide supply range 16V-60V
- *Internal output protection diodes
- *94 dB ripple rejection

APPLICATIONS

- *High performance audio systems
- *Bridge amplifiers
- *Stereo phonographs
- *Servo amplifiers
- *Instrument systems

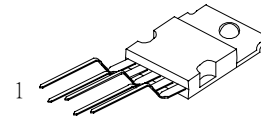

TO-220B

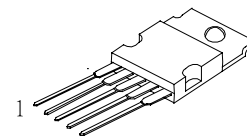

TO-220-5

1: +IN 2: -IN 3: -VEE
4: Output 5: Vcc

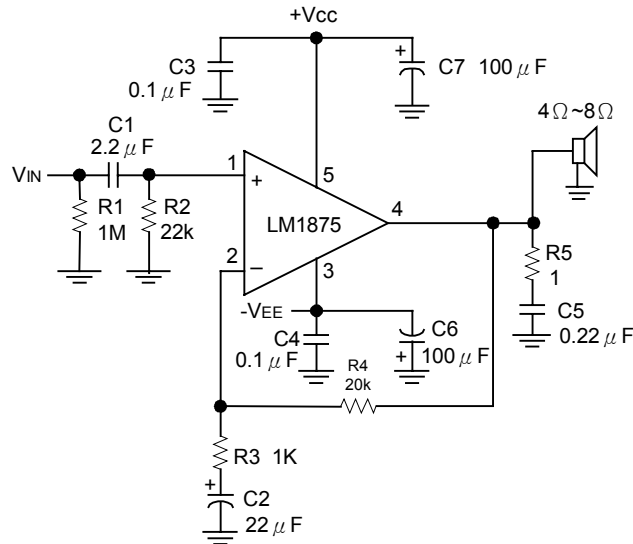
TYPICAL APPLICATIONS

ABSOLUTE MAXIMUM RATINGS

PARAMETER	SYMBOL	RATING	UNIT
Supply Voltage	V_s	60	V
Input Voltage	V_{IN}	$-V_{EE} \sim V_{CC}$	V
Storage Temperature	T_{stg}	-65 ~ +150	°C
Junction Temperature	T_J	150	°C
Lead Temperature(Soldering,10 seconds)	T_L	260	°C

THERMAL DATA

DESCRIPTION	SYMBOL	RATING	UNIT
Thermal Resistance, Junction-case	θ_{JC}	3	°C/W
Thermal Resistance, Junction-ambient	θ_{JA}	73	°C/W

ELECTRICAL CHARACTERISTICS

$V_{CC}=+25V, -V_{EE}=-25V, T_{AMBIENT}=25^{\circ}C, R_L=8\Omega, A_v=20(26dB), f_o=1kHz$, unless otherwise specified.

PARAMETER	SYMBOL	TEST CONDITIONS	MIN	TYP	MAX	UNIT
Supply Current	V_s	$P_{OUT}=0W$		70	100	mA
Output Power(Note 1)	P_o	THD=1%		25		W
Total Harmonic Distortion (Note 1)	THD	$P_{OUT}=20W, f_o=1kHz$ $P_{OUT}=20W, f_o=20kHz$ $P_{OUT}=20W, R_L=4\Omega, f_o=1kHz$ $P_{OUT}=20W, R_L=4\Omega, f_o=20kHz$		0.015 0.05 0.022 0.07	0.4 0.6	%
Offset Voltage	V_{os}			± 1	± 15	mV

PARAMETER	SYMBOL	CONDITIONS	MIN	TYP	MAX	UNIT
Input Bias current	I_{IB}			± 0.2	± 2	μA
Input Offset Current	I_{IO}			0	± 0.5	μA
Gain-Bandwidth Product	GBW	$f_o = 20kHz$		5.5		MHz
Open Loop Gain	G_v	DC		90		dB
Power Supply Rejection Ratio	PSRR	$V_{CC}, 1kHz, 1 V_{rms}$		95	52	dB
		$V_{EE}, 1kHz, 1 V_{rms}$		83	52	
Max Slew Rate	SR	20W, 8 Ω , 70kHz BW		8		V/ μs
Current Limit	I_{LIM}	$V_{OUT} = V_{SUPPLY} - 10V$		4	3	A
Equivalent Input Noise Voltage	e_n	$R_s = 600 \Omega, CCIR$		3		μV_{rms}

Note 1: Assumes the use of a heat sink having a thermal resistance of 1°C/W and no insulator with an ambient temperature of 25°C. Because the output limiting circuitry has a negative temperature coefficient, the maximum output power delivered to a 4 Ω load may be slightly reduced when the tab temperature exceeds 55°C.

TYPICAL APPLICATIONS(CONTINUED)

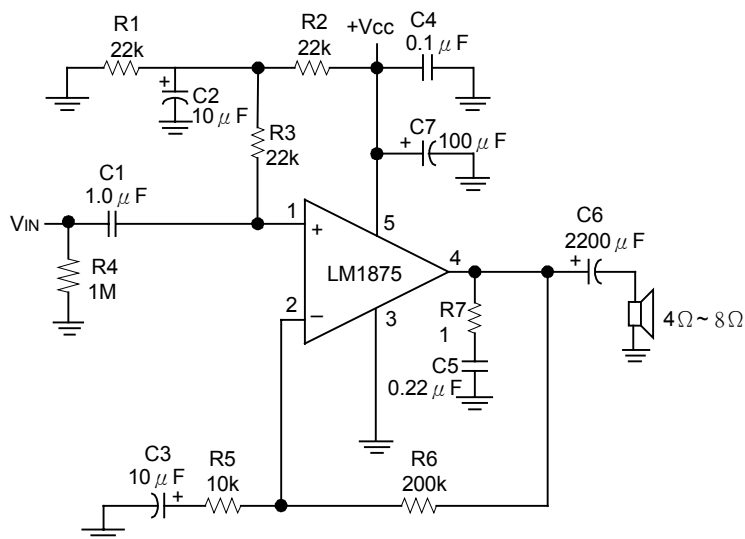

TYPICAL PERFORMANCE CHARACTERISTICS

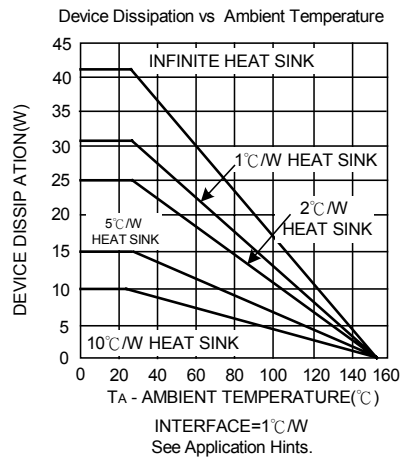
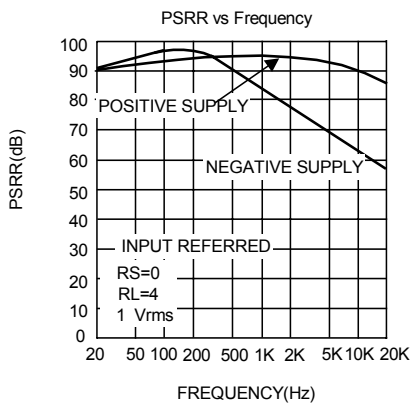
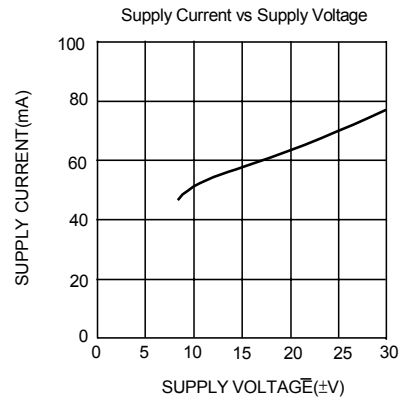
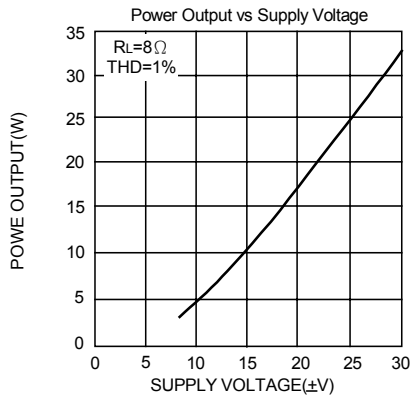
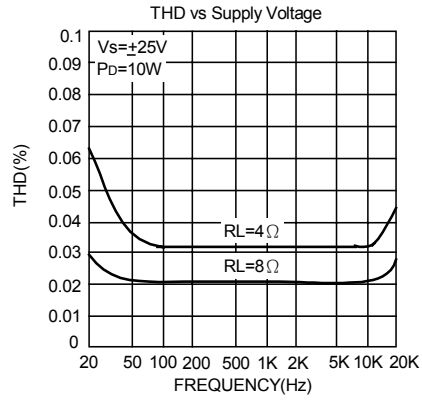
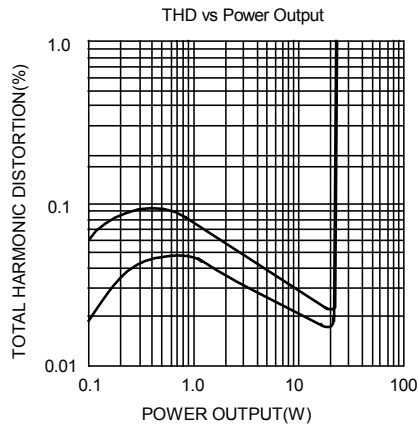

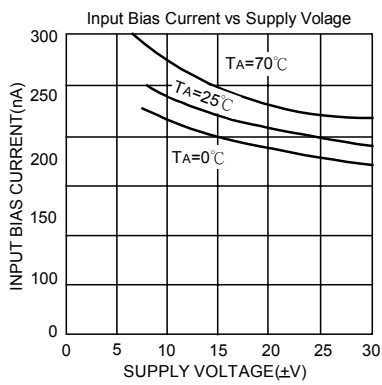
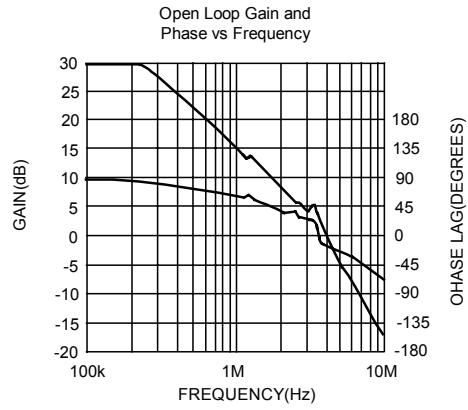
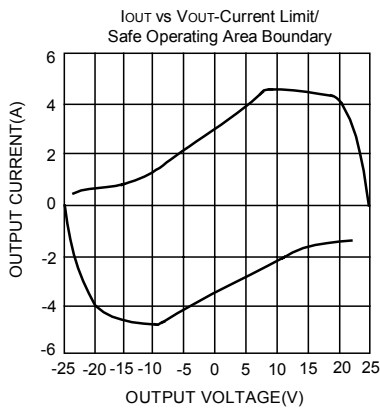
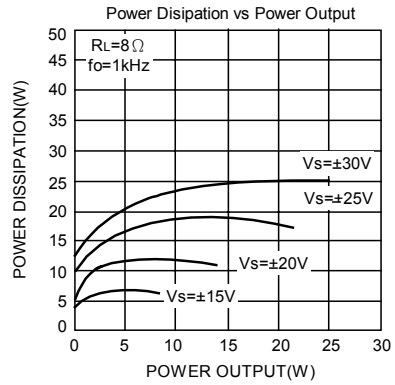
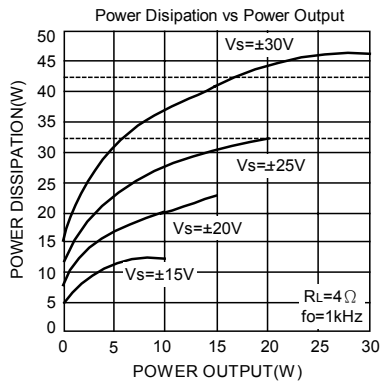

* Thermal shutdown with infinite heat sink
**Thermal shutdown with 1°C/W heat sink

