



广州市东裕光电科技有限公司
GUANGZHOU TONYU TECHNOLOGY CO., LTD

产品规格书 SPECIFICATION

客户名称 CUSTOMER	
产品名称 PRODUCTION	对射式（槽型）光电开关 Transmissive Sensor
产品型号 MODEL	DY-ITR9707
版本号 VERSION NO	A1.0

地址(Add): 广东省广州市番禺区石基镇海涌路3号10号厂房2楼

电话(Tel): 020-39294688

传真(Fax): 020-39966833

邮箱(E-mail): zlx@dyled.cn

网址(Net): www.tonyuled.com



客户确认 CUSTOMER CONFIRMATION	审核 CHECKED BY	编制 PREPARED BY
	汪建新	陈少龙

DY-ITR9707

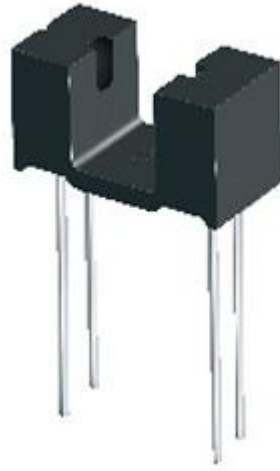

产品描述 Descriptions

- 对射式（槽型）光电开关。
(An transmissive sensor)

产品特性 Features

- 可靠性高 (High reliability)
- 响应时间快 (Fast response time)
- 解析度高 (High analytic)
- 敏感度高 (High sensitivity)
- 截止波长 940nm (Cut-off visible wavelength $\lambda_P=940\text{nm}$)
- 无铅 (Pb free)
- 符合 RoHS 要求 (This product itself will remain within RoHS compliant version)

产品应用 Applications

- 鼠标 (Mouse Copier)
- 码盘 (Switchc Scanner)
- 非接触式开关 (Non-contact Switching)
- 智能家电 (Smart Appliances)

包装方式 Packing Quantity Specification

- 袋装：150PCS/袋，5 袋/小盒，10 小盒/箱(150PCS/1Bag, 5Bags/1Box, 10Boxes/1Carton)

一、外形图 Outline dimensions:

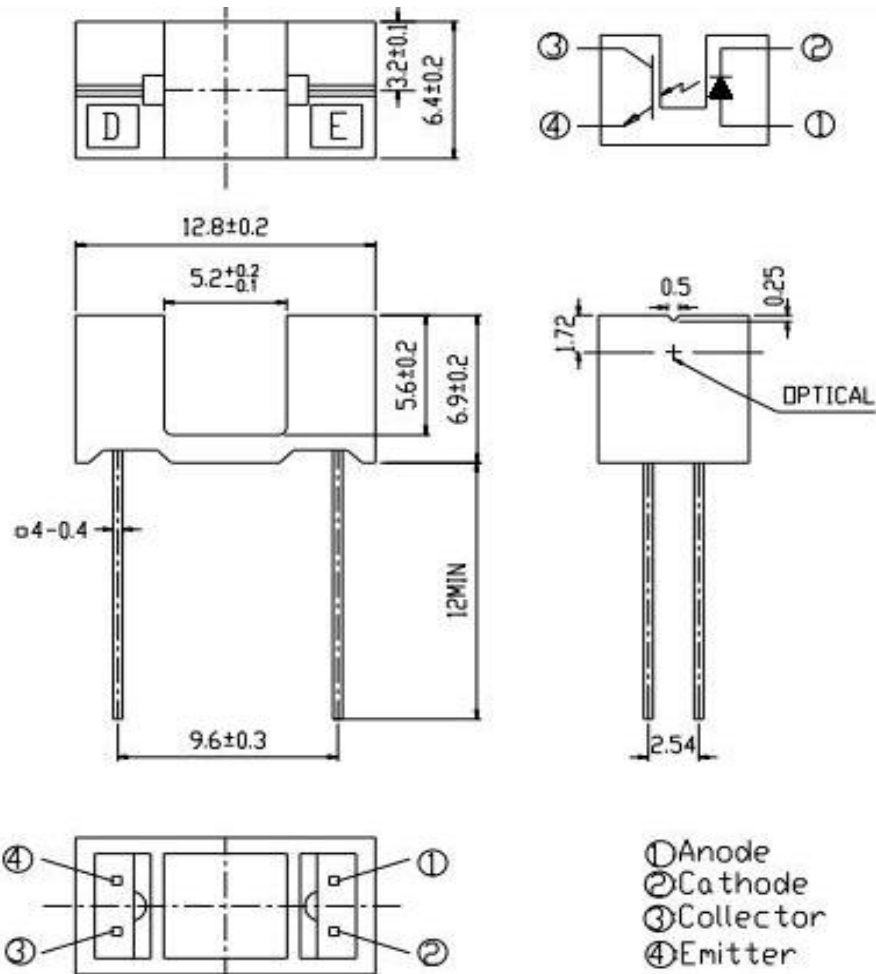

注(Notes): 1、所有尺寸均以毫米为单位(All dimensions are in millimeters)。
2、尺寸公差值为 ± 0.25 mm(Tolerances unless dimensions ± 0.25 mm)。

※备注：承认书之编号和型号可用于查询，客户如有需要，请提供相应的编号和型号。

Remark: P/N & Model in samples approval sheet can be used to inquire, please provide corresponding P/N & model if customer need.

二、光电参数 Electro-Optical Characteristics:

(环境温度 Ambient temperature: 25°C, 环境湿度 Humidity: RH60%)

项目 Item	符号 Symbol	测试条件 Test condition	最小值 Min.	典型值 Type	最大值 Max..	单位 Unit.	
输入 Input	正向电压 Forward voltage	V_F	$I_F=20\text{mA}$	-	1.2	1.5	V
	反向电流 Reverse current	I_R	$V_R=5\text{V}$	-	-	10	μA
	峰值波长 Peak wavelength	λ_p	$I_F=20\text{mA}$	-	940	-	nm
输出 Output	暗电流 Dark Current	I_{CEO}	$V_{CE}=20\text{V}$ $E_e=0\text{mW/cm}^2$	-	-	100	nA
	C-E 饱和电压 C-E Saturation Voltage	$V_{CE(sat)}$	$I_C=2\text{mA}$, $E_e=1\text{mW/cm}^2$	-	-	0.4	V
集电极电流(*) Collector Current(*)		$I_{C(ON)}$	$V_{CE}=5\text{V}, I_F=20\text{mA}$	0.5	-	-	mA
		$I_{C(OFF)}$		-	-	20	μA
响应时间 Response Time	上升时间 Rise Time	T_R	$V_{CE}=5\text{V}, I_C=1\text{mA}$ $R_L=1\text{K}\Omega$	-	15	-	μs
	下降时间 Fall Time	T_F		-	15	-	μs

注(Notes): *正向电压公差范围(Forward voltage tolerance): $\pm 0.1\text{v}$

*辐射强度公差范围(Radiant intensity tolerance): $\pm 10\%$

*波长公差范围(wavelength tolerance): $\pm 1.0\text{nm}$

三、典型光电特性曲线图 Typical photoelectricity characteristic curve chart:

IR 光电特性图 Typical Characteristics For IR

Fig.1 Forward Current vs.

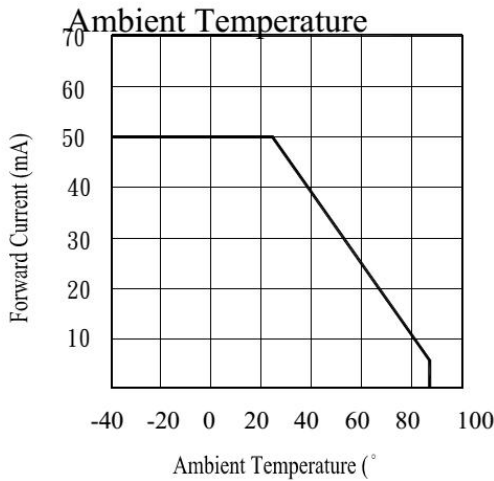

Fig.2 Spectral Distribution

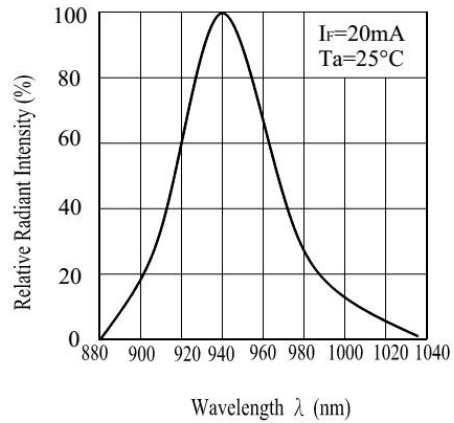

Fig.5 Relative Intensity vs.

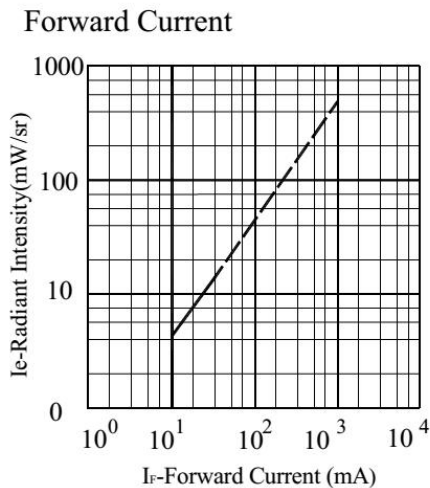

Fig.6 Relative Radiant Intensity vs.

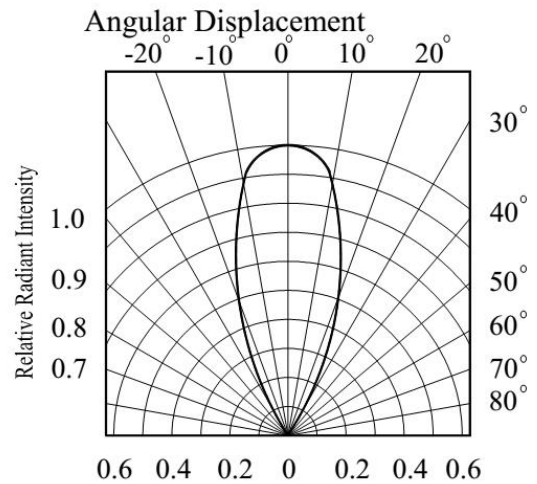

Fig.7 Relative Intensity vs.

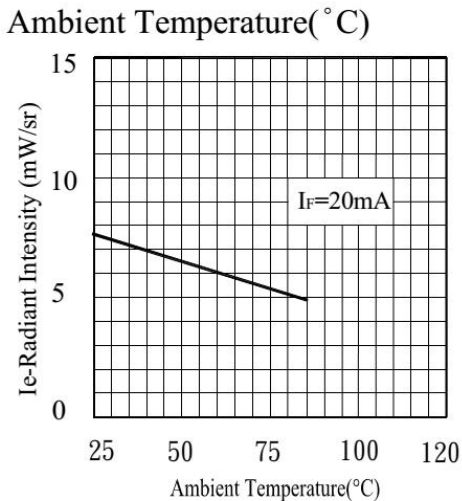
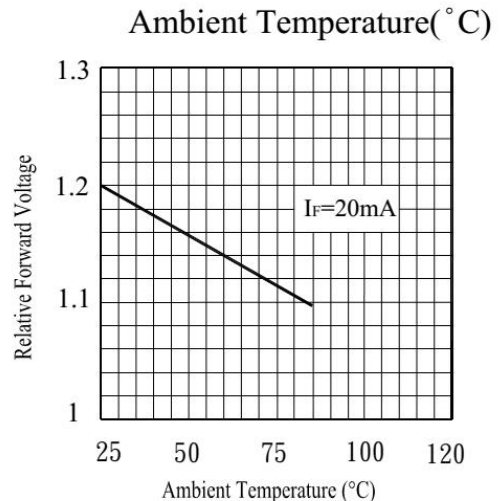

Fig.8 Forward Current vs.



PT 光电特性图 Typical Characteristics For PT

Fig.1 Collector Power Dissipation vs. Ambient Temperature

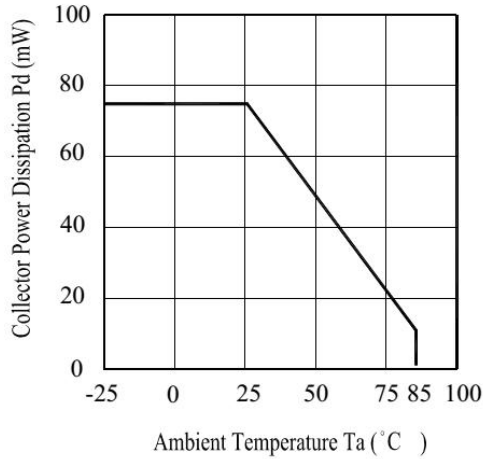

Fig.2 Spectral Sensitivity

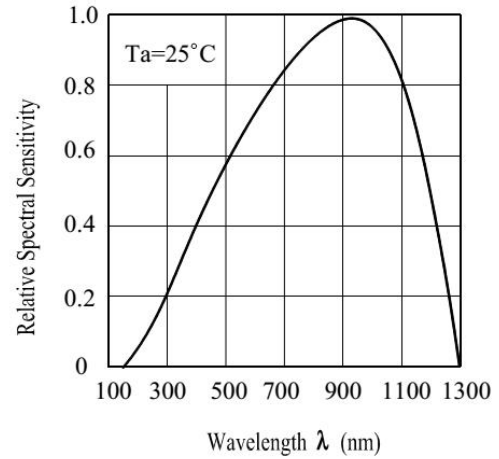

Fig.3 Relative Collector Current vs. Ambient Temperature

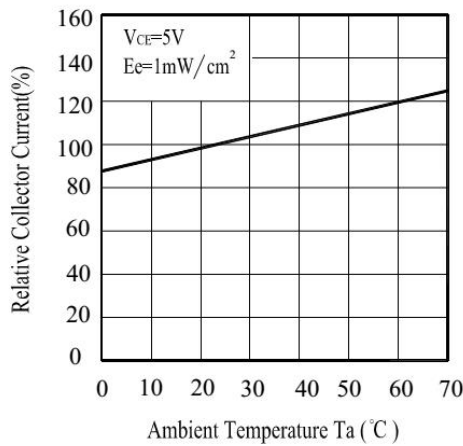

Fig.4 Collector Current vs. Irradiance

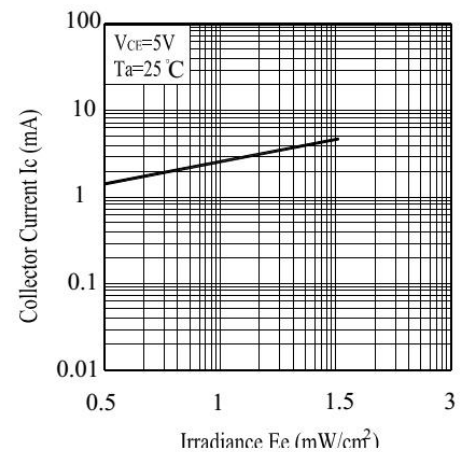

Fig.5 Collector Dark Current vs. Ambient Temperature

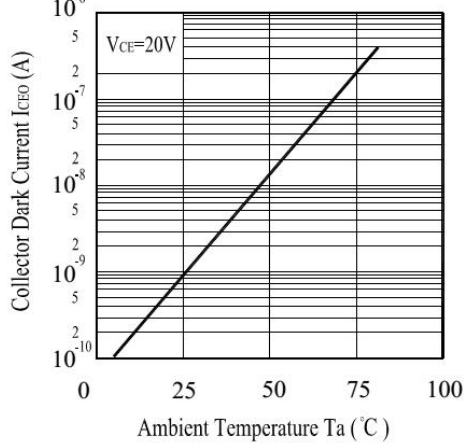
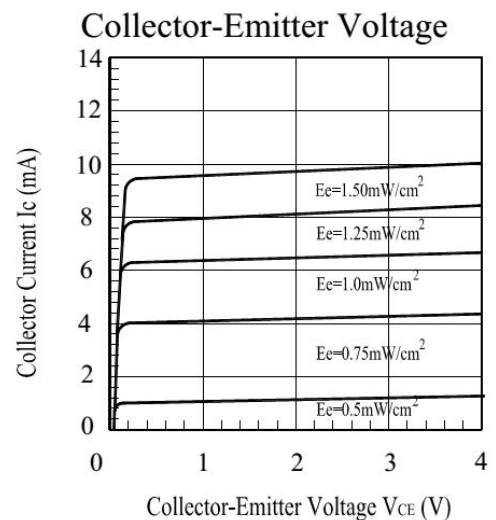

Fig.6 Collector Current vs. Collector-Emitter Voltage



四、极限参数 Absolute Maximum Rating:

(环境温度 Ambient temperature: 25°C, 环境湿度 Humidity: RH60%)

项目 Item	符号 Symbol	数值 Value	单位 Unit	备注 Remark	
输入 Input	常温下功耗 Power Dissipation	Pd	75	mW	at(or below) 25°C Free Air Temperature
	反向耐压 Reverse Voltage	V _R	5	V	---
	正向电流 Forward Current	I _F	50-	mA	---
	正向峰值电流 Peak forward current	I _{FP}	1	A	Pulse width ≤ 100μs, Duty cycle=1% tw=100 μsec, T=10 msec
输出 Output	集电极功耗 Collector Power Dissipation	Pc	75	mW	---
	集电极电流 Collector Current	I _c	20	mA	---
	C-E 电压 Collector-Emitter Voltage	BV _{CEO}	30	V	
	E-C 电压 Emitter-Collector Voltage	BV _{ECO}	5	V	
使用温度 Operating Temperature	T _{opr}	-25~+85	°C		
储存温度 Storage Temperature	T _{stg}	-45~+85	°C		
焊接温度 Soldering temperature	T _{sol}	260	°C	波峰焊, 离环氧体 3mm 处, ≤3S Wave soldering, 3mm out of physical body, ≤3S	

五、可靠性实验项目 Reliability Test Project:

描述 Description	项目 Item	测试标准 Test criterion	测试条件 Test condition	测试时间 Test time	数量 Qty.	失效数量 Fail Qty.
寿命测试 Life test	常温寿命测试 Life test (room temperature)	JIS7021:B4	Ta=25°C±5°C, IF=20mA	1000Hrs	22	0
环境测试 Ambience test	高温存储 High temperature store	JIS7021:B10 MIL-STD-202:210A MIL-STD-750:2031	Ta=85°C±5°C	1000Hrs	22	0
	低温存储 Low temperature store	JIS7021:B12	Ta= -35°C±5°C	1000Hrs	22	0
	高温高湿测试 High temperature/ humidity test	JIS7021:B11 MIL-STD-202:103D	Ta=85°C±5°C RH=85%	1000Hrs	22	0
	冷热冲击测试 Cold / Heat strike test	JIS7021:B4 MIL-STD-202:107D MIL-STD-750:1026	30min -10°C±5°C ←→ 100°C±5°C 5min 5min	50Cycles	22	0
	冷热循环测试 Cold and heat cycle test	JIS7021:A3 MIL-STD-202:107D MIL-STD-705:105E	5min 5min 5min -35°C ~ 25°C ~ 85°C ~ -35°C 30min 5min 30min 5min	50Cycles	22	0

六、注意事项 Note:

1、引脚成形方法 LED bracket forming method

(1) 必需离胶体 3 毫米才能折弯支架。

The pin of LED can be bent where is at least 3mm out of LED colloid.

(2) 支架成形必须用夹具或由专业人员来完成。

Must use fixture to deform the LED bracket.

(3) 支架成形必须在焊接前完成。

Finishing the forming of LED bracket must be before soldering.

(4) 支架成形需保证引脚和间距与线路板上一致。

Guarantee the gap between two pin of LED tallys with LED pads in PCB when forming.

2、烙铁焊接 Manual soldering

烙铁（最高 30W）尖端温度不超过 300°C；焊接时间不超过 3 秒；焊接位置至少离胶体 3 毫米。

The tip temperature of soldering iron don't exceed 300°C; soldering time don't exceed 3s and soldering position must be 3mm out of led colloid.

3、防静电措施 ESD countermeasure

静电及高压会对 LED 造成损坏，特别是芯片材质为 InGaN 的产品对静电防护要求更加严格，要求在使用和检验产品时戴防静电手腕带或防静电手套，焊接工具及设备外壳需可靠接地，焊接条件遵循此份规格书中的

条件。

Static electricity and high volt can damage LED, The production whose Die material is InGaN must strictly required to prevent ESD, Must put on static glove and static fillet, Soldering tool and the cover of device must connect the ground, soldering condition follows the related stating of production specification manual.

4、过电流保护 Protecting countermeasure when over current

为避免由于电压的变化引起大电流冲击而造成产品损坏，需要加入保护电阻。

Need add the protecting resistor in circuit in order to avoid damaging led due to big current and voltage fluctuation.

5、LED 安装方法 LED installation method

(1) 注意各类器件外线的排列以防极性装错，器件不可与发热组件靠得太近，工作条件不要超过其规定的极限。

Pay attention to the LED polarity and avoid installation wrong. LED can't be close to euthermic component, work condition should tally with it's specification.

(2) 务必不要在引脚间距变形的情况下安装 LED。

Don't install the LED under the condition of the led pin deformation.

(3) 当装配 LED 进入 PCB 或装配孔时，LED 支架不能承受任何压力。

The LED bracket don't load any pressure when installing the LED into PCB or fitting hole.

(4) 在焊接温度回到正常以前，必须避免使 LED 受到任何的震动或外力。

Must avoid any strike and force on LED before the soldering temperature return to room temperature.

6、存储时间 Storage time

(1) 在温度 5℃~35℃，湿度 RH60%条件下，产品可保存一年。超过保存期的产品需重新检测后方可使用。

LED can be stored for a year under the condition: the temperature of 5℃~35℃ and humidity of RH60%, These production must be re-inspected and tested before use if their storage time exceed a year.

(2) 如果打开的产品在 5℃~35℃，RH60%的空气条件下放置超过一周，则需要将产品在 65℃±5℃的环境中放置 24 小时以上，并尽量在十五天内使用。

If LED is exposed in air for a week under the condition: the temperature of 5℃~35℃, humidity of RH60%, must place the LED in the ambience of 65℃±5℃ for 24 hours and use it in 15 days for best.

7、清洗 Cleaning

当用化学用品清洗胶体时必须特别小心，因为有些化学品对胶体表面有损伤并引起褪色如三氯乙烯、丙酮等。可用乙醇擦拭、浸渍，时间在常温下不超过 3 分钟。

Be careful of some chemical results in the LED colloid fades and damage when using chemical clean the LED, such as chloroethylene, acetone etc. Can use ethanol to wash or soak LED but the time don't exceed 3 minutes.

8、弯脚 Kinked

当 LED 成形弯脚时，弯脚模具容易刮花 LED 脚支架镀层，刮伤处容易生锈，特别是空气湿度大时。为减少生锈机会，建议使用镀锡支架。

The kinked tooling scrape easily the pin of LED, where the LED bracket is rusting easily, especial expose it in moist air. To decrease the LED bracket rust, advise using plated tin LED bracket.