

N-Channel Enhancement MOSFET

■ Features

- $V_{DS}=20V$
- $R_{DS(on)}=85m\Omega@V_{GS}=4.5V, I_D=3.6A$
- $R_{DS(on)}=115m\Omega@V_{GS}=2.5V, I_D=3.1A$

■ Marking

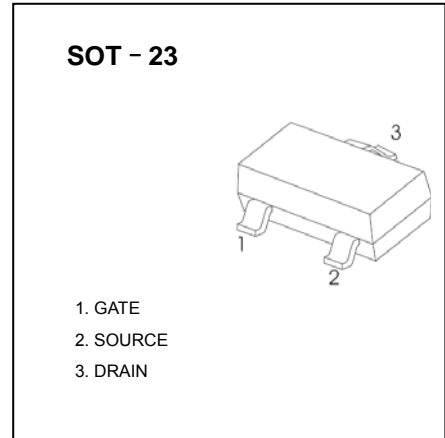
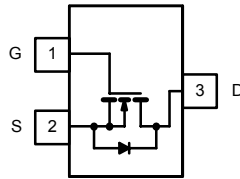
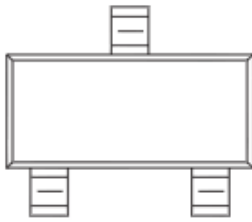

■ Absolute Maximum Ratings $T_a = 25^{\circ}C$

Parameter		Symbol	Rating	Unit
Drain-Source Voltage		V_{DS}	20	V
Gate-Source Voltage		V_{GS}	± 8	
Continuous Drain Current *1	$T_a=25^{\circ}C$	I_D	2.8	A
	$T_a=70^{\circ}C$		2.2	
Pulsed Drain Current		I_{DM}	10	
Power Dissipati	$T_a=25^{\circ}C$	P_D	1.25	W
	$T_a=70^{\circ}C$		0.8	
Thermal Resistance.Junction- to-Ambient *1	*1	R_{thJA}	100	$^{\circ}C/W$
	*2		166	
Junction Temperature		T_J	150	$^{\circ}C$
Storage Temperature Range		T_{stg}	-55 to 150	

Notes:

*1.Surface Mounted on FR4 Board, $t \leq 5$ sec.

*2.Surface Mounted on FR4 Board.

N-Channel Enhancement MOSFET
■ Electrical Characteristics Ta = 25°C

Parameter	Symbol	Test Conditions	Min	Typ	Max	Unit
Drain-Source Breakdown Voltage	V _{DSS}	I _D =250 μ A, V _{GS} =0V	20			V
Zero Gate Voltage Drain Current	I _{DSS}	V _{DS} =20V, V _{GS} =0V			1	μ A
		V _{DS} =20V, V _{GS} =0V, T _J =55 °C			10	
Gate-Body Leakage Current	I _{GSS}	V _{DS} =0V, V _{GS} =± 8V			± 100	nA
Gate Threshold Voltage	V _{GS(th)}	V _{DS} =V _{GS} , I _D =250 μ A	0.62	0.95	1.9	V
Static Drain-Source On-Resistance	R _{DS(on)}	V _{GS} =4.5V, I _D =3.6A		45	85	mΩ
		V _{GS} =2.5V, I _D =3.1A		70	115	
Forward Transconductance *	g _{fs}	V _{DS} =5V, I _D =3.6A		8		S
Input Capacitance	C _{iss}	V _{GS} =0V, V _{DS} =10V, f=1MHz		300		pF
Output Capacitance	C _{oss}			120		
Reverse Transfer Capacitance	C _{rss}			80		
Total Gate Charge	Q _g	V _{DS} =10V, V _{GS} =4.5V, I _D =3.6A		4	10	nC
Gate-Source Charge	Q _{gs}			0.65		
Gate-Drain Charge	Q _{gd}			1.5		
Turn-On DelayTime	t _{d(on)}	V _{GS} =4.5V, V _{DS} =10V, R _L =5.5 Ω, R _{GEN} =6 Ω I _D =3.6A		7	15	ns
Turn-On Rise Time	t _r			55	80	
Turn-Off DelayTime	t _{d(off)}			16	60	
Turn-Off Fall Time	t _f			10	25	
Continuous Source Current (Diode Conduction)	I _S			1.6		A
Diode Forward Voltage	V _{SD}	I _S =1.6A, V _{GS} =0V		0.76	1.2	V

* Pulse test: PW ≤ 300us duty cycle ≤ 2%

N-Channel Enhancement MOSFET

■ Typical Characteristics

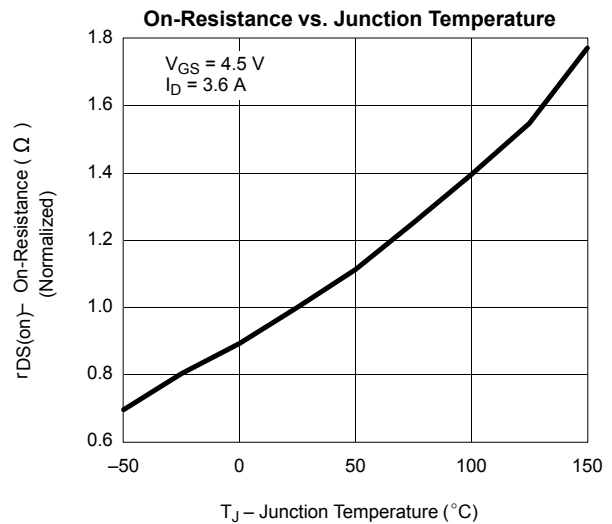
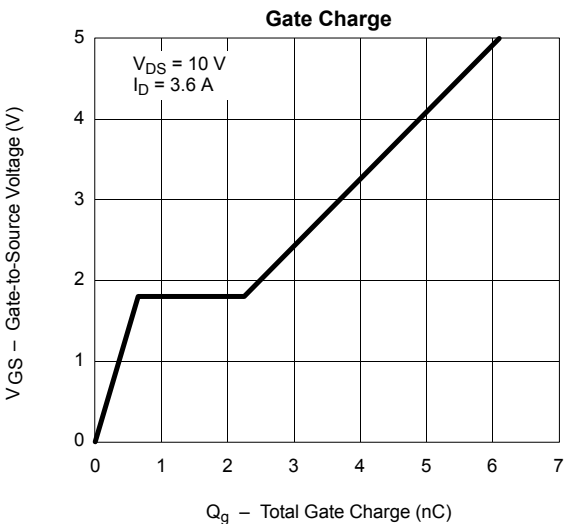
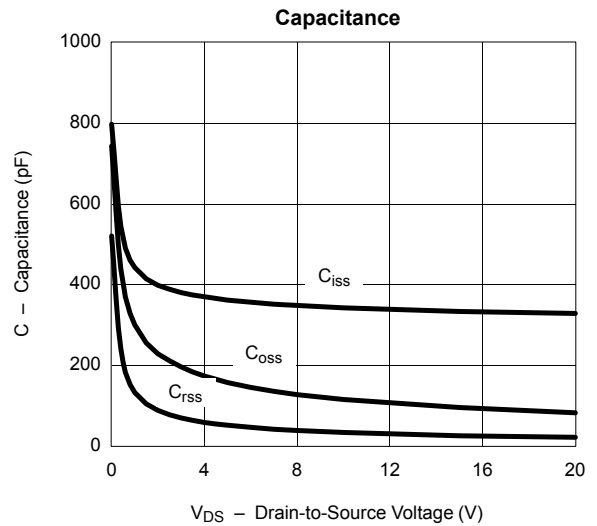
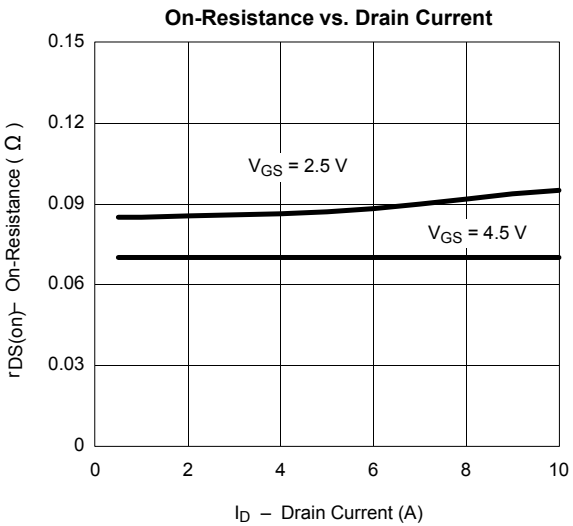
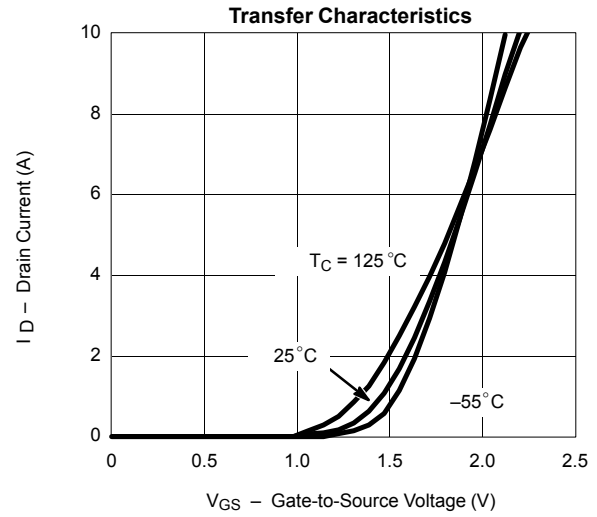
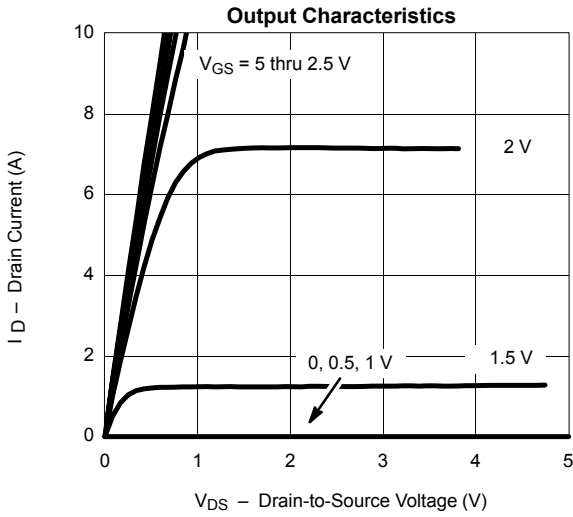

N-Channel Enhancement MOSFET

■ Typical Characteristics

Source-Drain Diode Forward Voltage

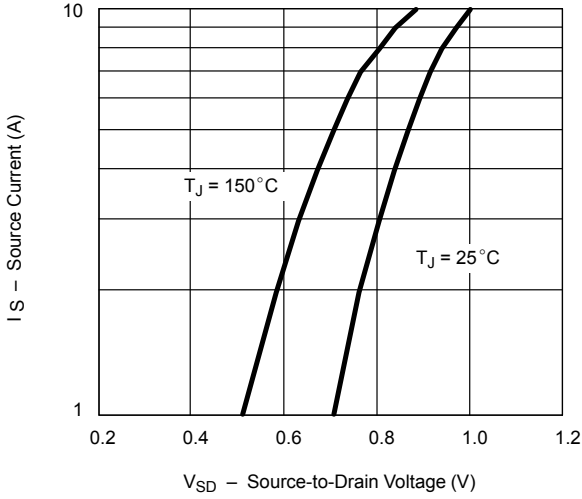

On-Resistance vs. Gate-to-Source Voltage

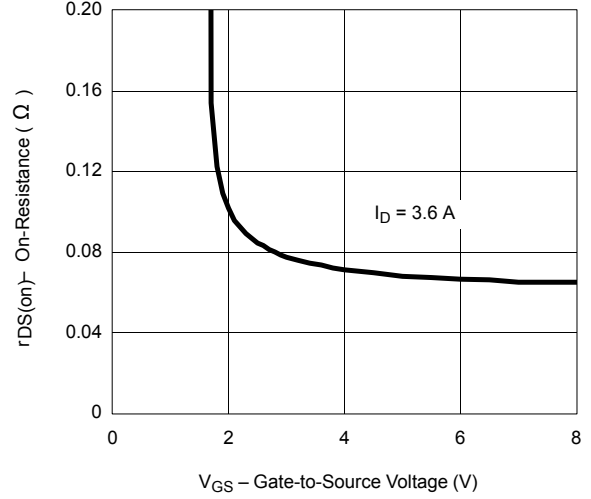

Threshold Voltage

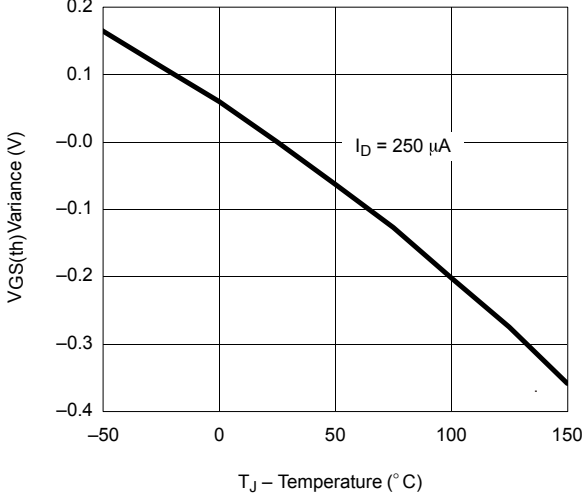

Single Pulse Power

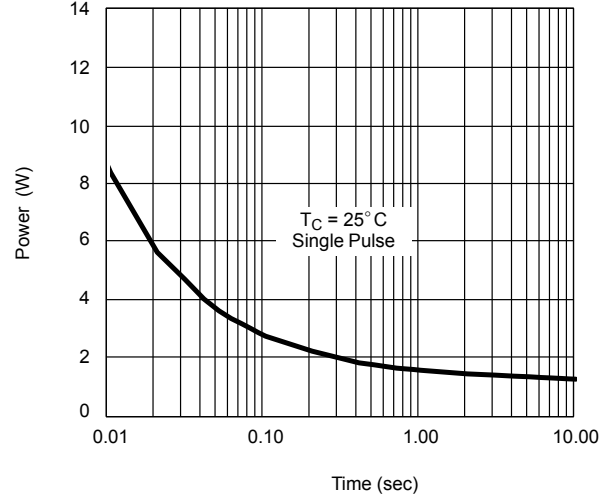

Normalized Thermal Transient Impedance, Junction-to-Ambient

