



### 产品特点



- ★ 超体积小、重量轻、灵敏度高，使用寿命长
- ★ 可提供2组(10A)触点转换
- ★ 可提供PCB印刷板式、插座式、法兰式安装
- ★ 可选配指示灯和二极管

### 型号说明

LL2C - L - 12VDC

瑞雷企业代号LEF

继电器设计代号/Relay Design Code

触点形式/Contact form 2C:2组转换

-L:LED指示灯 -F:法兰式 -P:焊接式 -D:内置二极管

-L:LED -F indicator: flange type -P:Welding -D:Built-in diode

线圈电压/Coil voltage 6,9,12,24,48,110,220VDC 6,12,24,36,48,110,220,240,380VAC

### 技术参数

外形尺寸 Dimension		27.2X21X35mm
触点 Contact	形式 Contact form	13F 2Z
	负载 (阻性) Rated load	10A
	最大切换电压 Max switching voltage	240VAC/28VDC
	接触电阻 (初始) Contact resistance	≤100mΩ
	触点材料 Material	银合金
	电气寿命 (频率1S通, 1S断) Electrical life	≥10 <sup>5</sup>
	机械寿命 (频率300次/1分钟) Mechanical life	≥10 <sup>7</sup>
吸合电压 (23°C) Max. allowed voltage		DC: ≤75% X 额定电压 AC: ≤80% X 额定电压
释放电压 (23°C) Release voltage		DC: ≤10% X 额定电压 DC: ≥30% X 额定电压
最大电压 (23°C) Max. allowed voltage		110% X 额定电压
线圈电压 Nominal voltage	直流 (DC)	DC: 6V~220V
	交流 (AC)	AC: 6V~380V
线圈功率 Coll power	直流 (DC)	DC: 0.9W
	交流 (AC)	AC: 1.2VA
吸合时间 Operate time		≤20ms
释放时间 Release time		≤20ms
介质耐压 Dielectric strength	同极触点之间 Between contacts	1000VAC/1min(漏电流1mA)
	异极触点之间 Between contacts (different pole)	1000VAC/1min(漏电流1mA)
	触点与线圈间 Between contacts and coil	1500VAC/1min(漏电流1mA)
绝缘电阻 Insulation resistance		≥1000m (500VDC)
环境温度 Ambient temperature		-25~+55°C
环境湿度 Ambient humidity		45%~75%RH
大气压力 Atmospheric pressure		86~106KPa
耐冲压 Resistance stamping		10G(正弦波半脉冲: 11ms)
耐振动 Vibration Resistance		10~55Hz 双振幅: 1.5mm
安装方式 Install model PCB		PCB印刷板式, 插座式
重量 Weight		约35g
包装信息 Package	内盒数量 Inner B Box Quantity	纸盒/20只每盒
	装箱数量 Carton Quantity	500只每箱
	外箱尺寸 Meas	长: 340 X 宽: 270 X 高: 350
	重量 Weight	净重: 15.85KG/每箱 毛重: 17.7KG/箱 外箱重量: 0.6KG 内盒重量: 0.05KG每盒



线圈参数

额定电压 DC(V)	额定电流 ±10(mA)	线圈电阻 ±10%(Ω)	最大连续外加电压 (V)	吸合电压 (Max)	释放电压 (Min)	额定功耗 (W)
6	150	40	额定电压 × 110%	≤ 额定电压 75%	≥ 额定电压 10%	0.9
12	75	60				
24	37.5	640				
48	18.7	2560				
110	8	13444				
127	7	17921				
220	4	53777				

额定电压 AC(V)	额定电流 ±10(mA)	线圈电阻 ±10%(Ω)	最大连续外加电压 (V)	吸合电压 (Max)	释放电压 (Min)	额定功耗 (AV)
6	200	10.5	额定电压 × 110%	≤ 额定电压 80%	≥ 额定电压 30%	1.2
12	100	42				
24	50	168				
48	25	672				
110	10.9	3529				
220	5.4	14116				
380	3.1	42116				

曲线性能图

最大切换功率 (1组转换型)

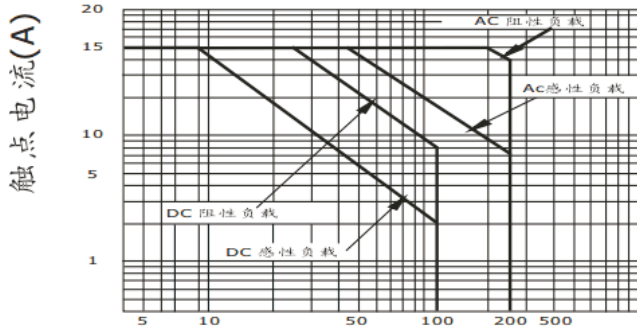

最大切换功率 (2、3、4组转换型)

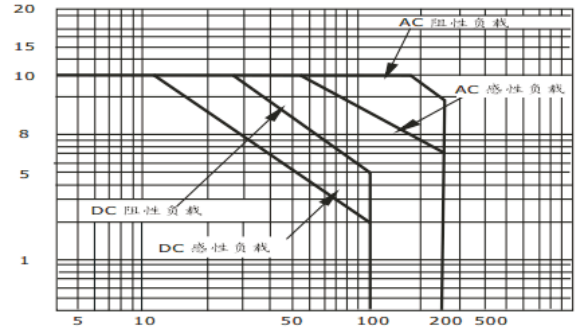

印字图





外形安装尺寸(mm)

[ LL2C ]

注：DC型号具有极性

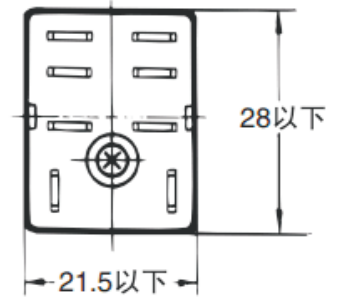
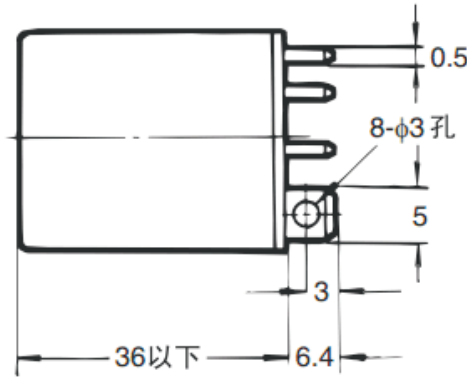
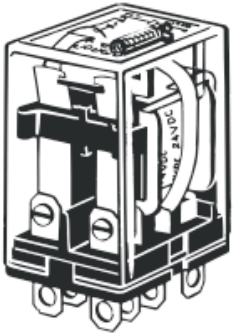

[ LL2C-F ]

注：8个3孔，上下形式的公差为0.1mm

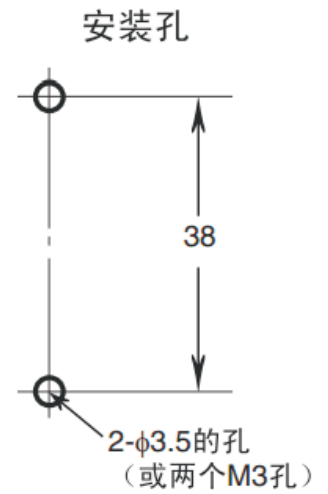
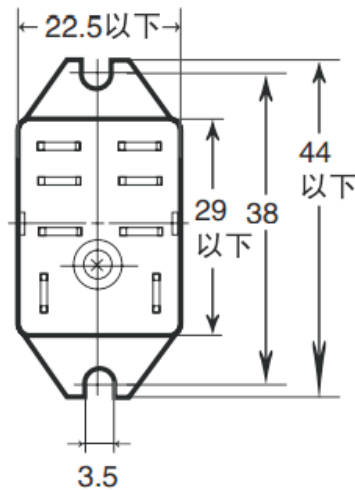
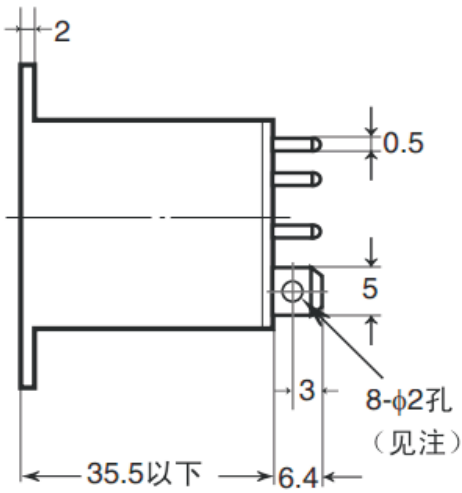

[ LL2C-P ]

注：尺寸公差为0.1mm

印刷电路板加工尺寸 (底视图)

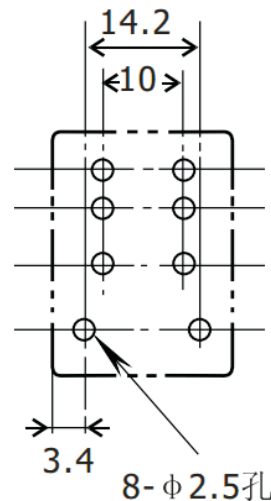
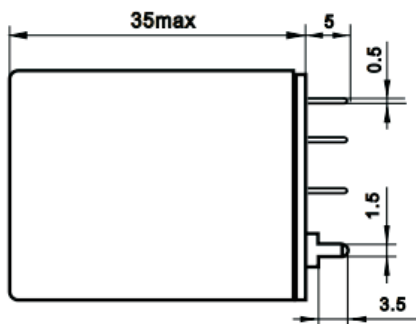



接线图

LL2C 端子配置/内部连接图 (底视图)

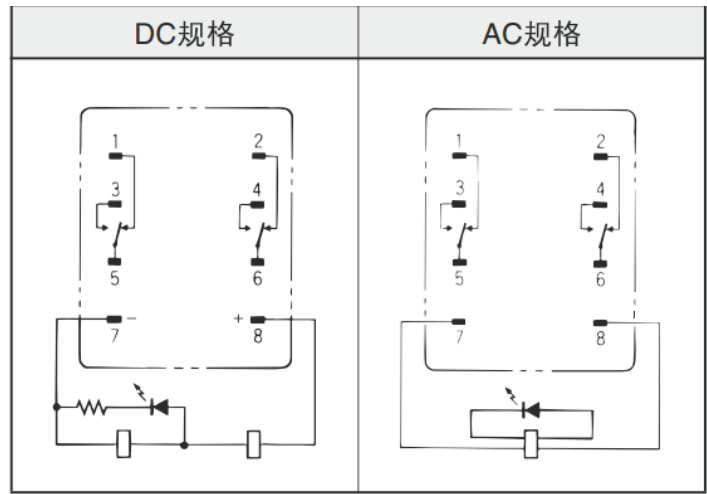
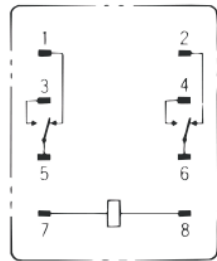

连接插座

[ LLS02-08A ]

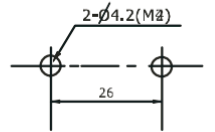
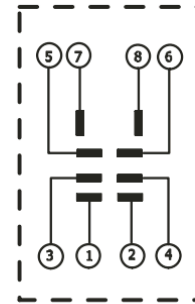
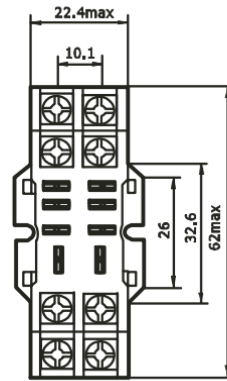
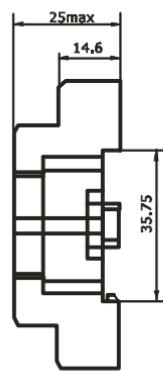

[ LLS01-08AE ]

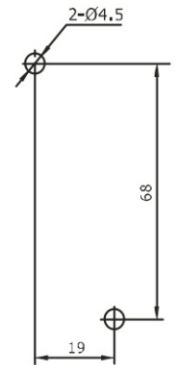
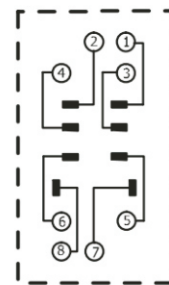
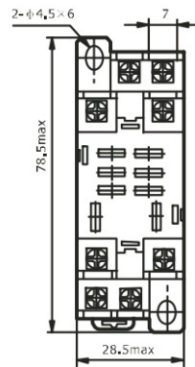
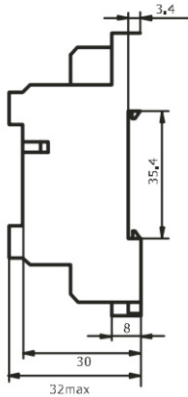

[ LLS01-08P ]

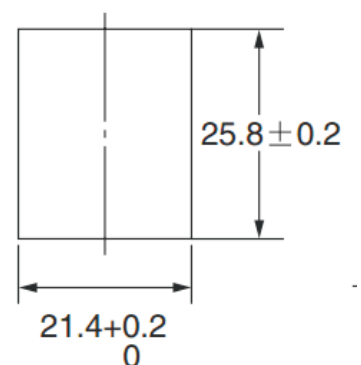
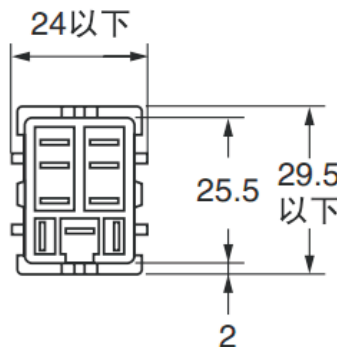
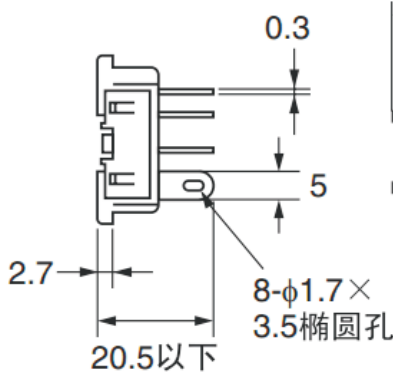



CAD数据

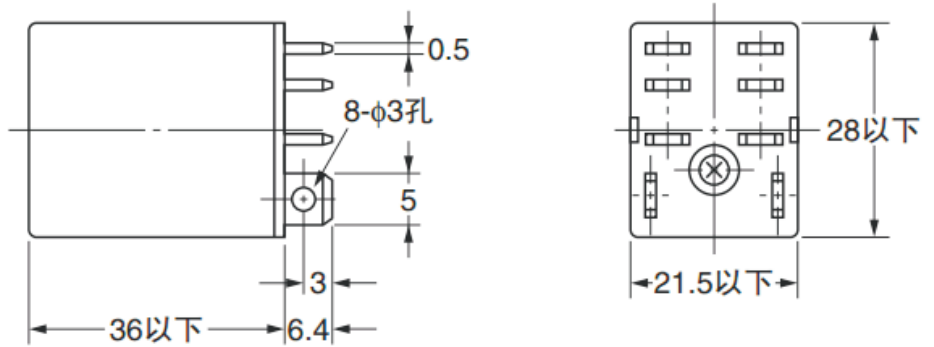
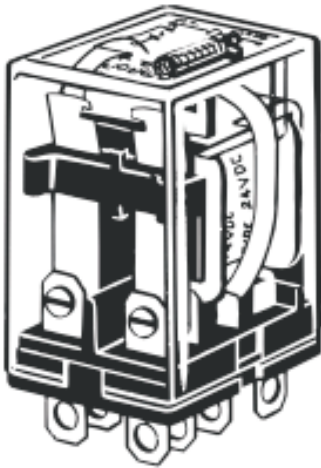

注:

- 1、对于DC规格，请在确认线圈极性后正确接线；
- 2、LED的颜色为AC红色、DC绿色；
- 3、动作指示灯显示线圈的通电情况，并非根据接点动作进行显示。

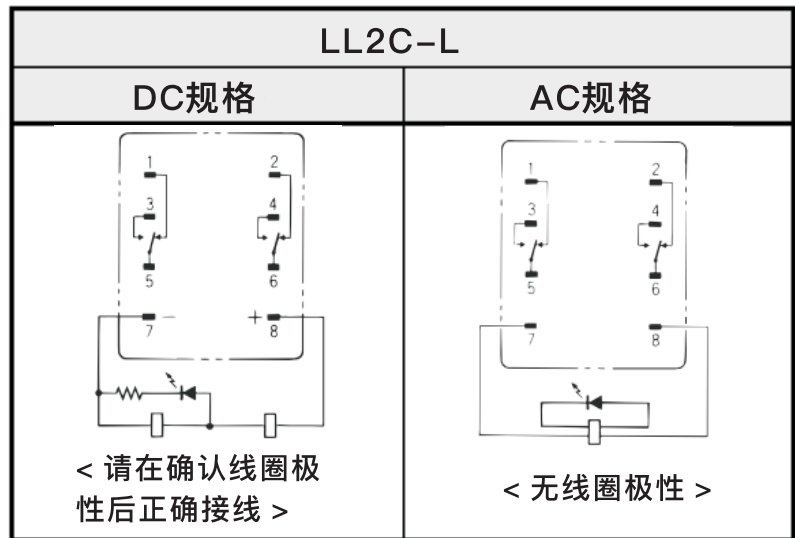

端子配置/内部连接图 (底视图)

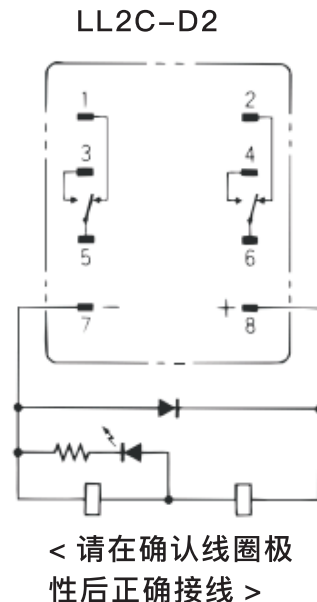
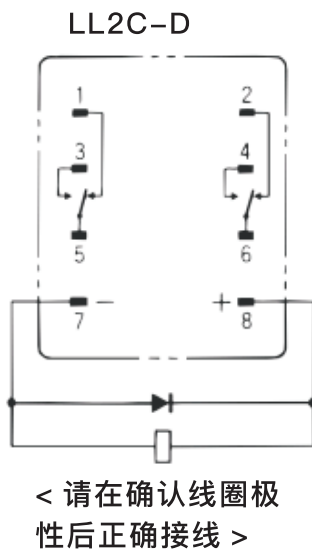
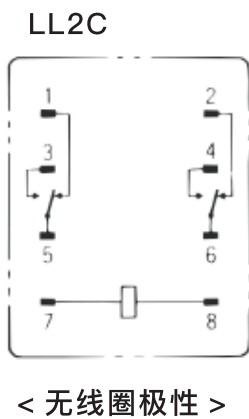

声明:

本产品规格书仅供客户使用参考，若有更改，恕不另行通知。  
对瑞雷工业而言，不可能评定继电器在每个具体应用领域的所有性能参数要求，因而客户应根据具体的使用条件选择与之相匹配的产品，若有疑问，请与瑞雷工业联系以便获取更多的技术支持。