

Operation: SMT & Hinge & 铰链式 钢质上盖 MINI SIM卡座



LTEM NO.: SIM-011T-R6 (Consumer Electronics)

(30.0L × 17.0W × 2.5H & MINI-SIM Sockets)

MEMORY-CARD-SOCKETS



Technical parameter

外焊贴装 SMT

PROJECT	LEVEL	A[better product]		B[average product]	
Electrical Properties	Contact Rating	25mA, 24V DC			
	Initial Contact Resistance	30mΩ max.		50mΩ max.	
	Insulation Resistance	100MΩ min. 500V DC			
	Withstand Voltage	500V AC for 1 minute		350 V AC for 1 minut	
Durable Performance	There No Load	5,000 Cycles		3,500 Cycles	
	Rated Load	3,500 Cycles		3,000 Cycles	
	Storage temp.	-25°C ~ +85°C (Operating Temp:)			

側向導入 LATERAL

精密部品 NICETY

可靠 STABILIZE

適合環保 RoHS

Page1

Unit:mm

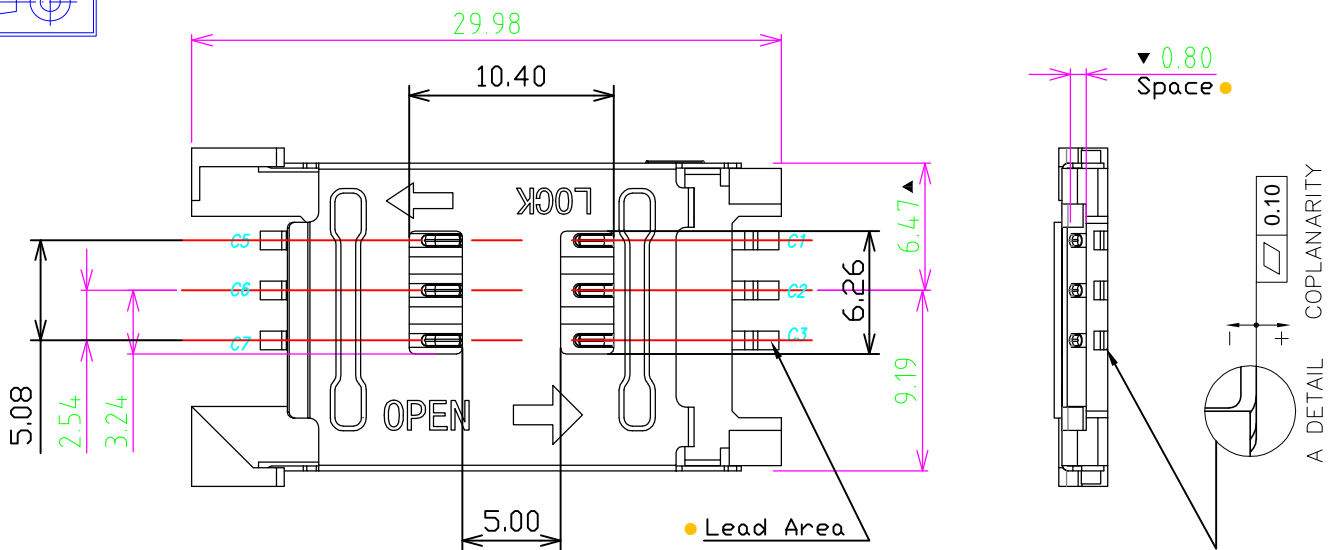
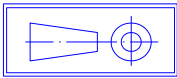

NAME	MATERIAL
① CONTACT	C5191-H 磷青铜 COPPER ALLOY [Gold Flash-6PIN]
② COVER	SUS301-3/4H (t=0.25mm) 不锈钢 【焊点镀金 1u"】
③ HOUSING	LCP S475 THERMOPLASTIC, UL 94V-0, COLOR: BLACK

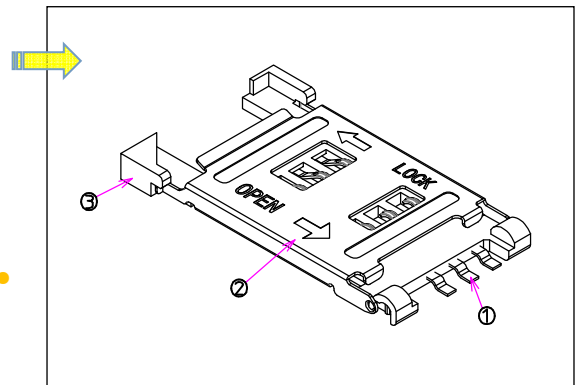
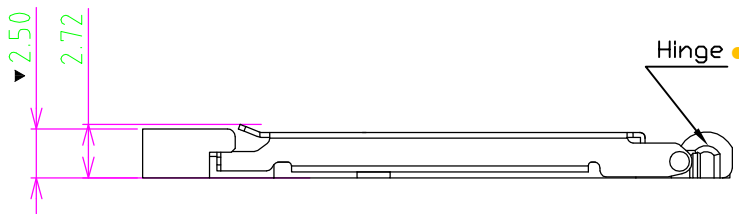

Operating Force

Inward 5.0~6.5N. (1N.=100gram-force)
 Exiting 5.0~6.5N. (1N.=100gram-force)

Solder-ability (Max.)

IR Reflow: 255°C, 5sec. Manual: 350°C, 3sec.

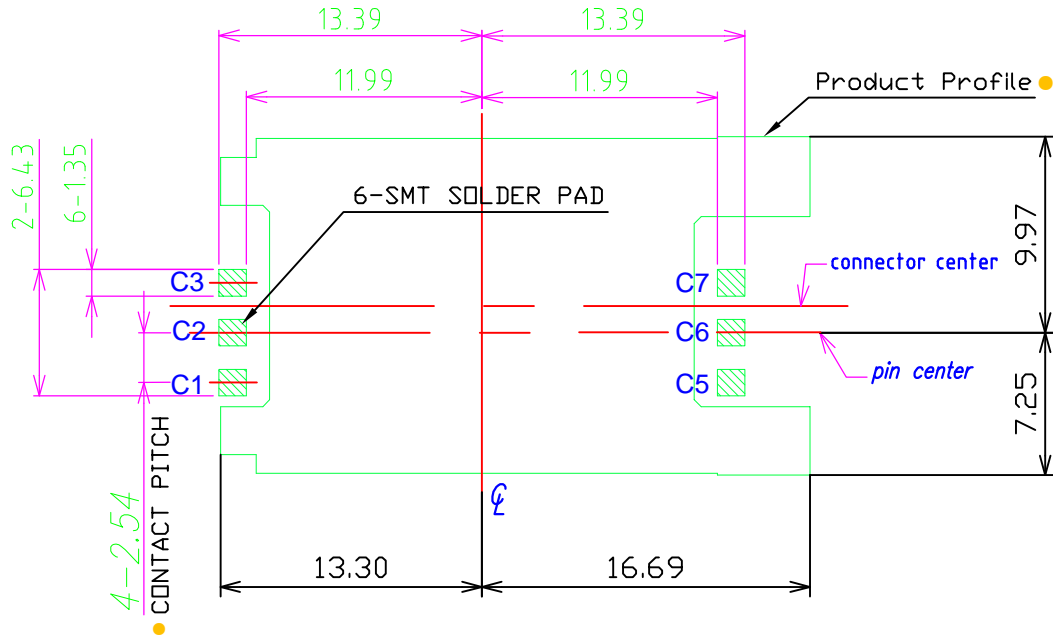

Pin definition

Pin No.	Pin NAME	Type	Description
C ①	卡電源	1	VCC
C ②	復位	1	RST
C ③	時鐘	1	CLK
C ⑤	接地	1	GND
C ⑥	Vpp	1	VPP
C ⑦	輸入/輸出	1	I/O

DECIMALS	ANGLES
X : ±0.50	X° : ±3°
X.X : ±0.35	X.X° : ±1°
X.XX : ±0.25	X.XX° : ±0.5°

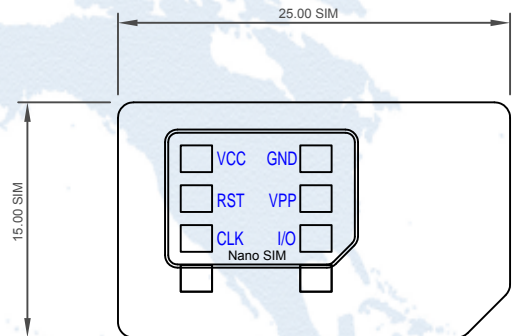

Reference

SIM CARD

回流方式的参考举例

1. 加热方式远红外线加热的上下加热方式。
2. 温度测量方式用 V0.1 ~ V0.2 的 CA(K) 或 CC(T) 进行测量。
3. 温度分布

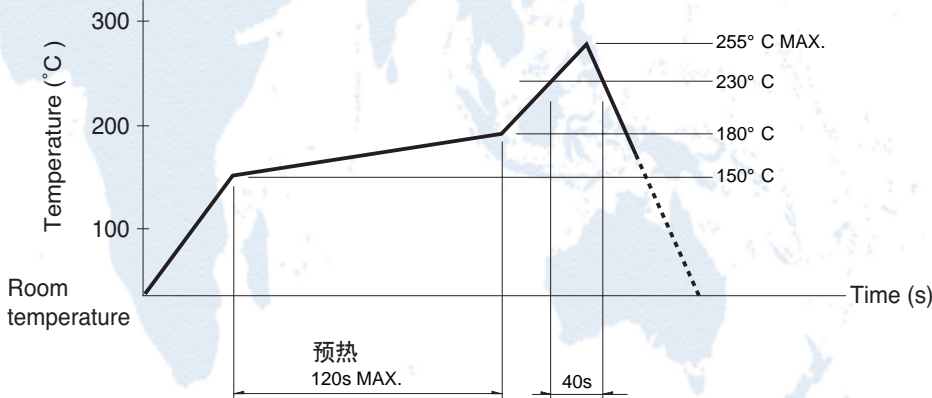

本品不屬於危害性廢棄物,須丟棄時可以委託回收商予以回收再生處理。Products do not belong to hazardous waste, When waste can recycling processing

運送時本產品不要直接與水、酸鹼性化學物質接觸,或放置於含有以上氣體環境中,並且需要注意會有滑落、側翻的危險發生; 運輸過程中不能有碰撞或者擠壓,須保證溫度與濕度適中 [常溫 25°C, 濕度在 50°C 以內], 不可導致材料變形或氧化。

注記 NOTICE

1. 碩方公司擁有最終解釋權; The SOFNG company reserves the right of final interpretation;
2. 文件禁止外洩、轉載; Leaked and reproduced prohibited;
3. 未經授權修改無效。Modify is invalid.