

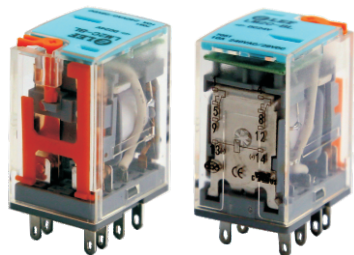

产品特点

- ★ 两组10A触点切换能力
- ★ 超体积小、重量轻、灵敏度高、使用寿命长
- ★ 可提供PCB印刷板式、插座式、法兰式安装
- ★ 可选配指示灯和二极管
- ★ 配有动作指示扣
- ★ 可内置线圈抑制电路



型号说明

LM2C-BL-12VDC

瑞雷企业代号LEF

设计代号/Design Code

触点形式/Contact form 2H:2组常开 2D:两组常闭 2C:两组转换

带测试按钮/With test button

带LED指示灯/LED indicator

线圈电压/Coil voltage 6,9,12,24,48,110,220VDC 6,12,24,36,48,110,220,240,380VAC

技术参数

外形尺寸 Dimension		27.2X21X35mm
触点 Contact	形式 Contact form	13F 2Z
	负载 (阻性) Rated load	10A
	最大切换电压 Max switching voltage	240VAC/28VDC
	接触电阻 (初始) Contact resistance	≤100mΩ
	触点材料 Material	银合金
	电气寿命 (频率1S通, 1S断) Electrical life	≥10 ⁵
	机械寿命 (频率300次/1分钟) Mechanical life	≥10 ⁷
吸合电压 (23°C) Max. allowed voltage		DC: ≤75% X 额定电压 AC: ≤80% X 额定电压
释放电压 (23°C) Release voltage		DC: ≤10% X 额定电压 DC: ≥30% X 额定电压
最大电压 (23°C) Max. allowed voltage		110% X 额定电压
线圈电压 Nominal voltage	直流 (DC)	DC: 6V~220V
	交流 (AC)	AC: 6V~380V
线圈功率 Coll power	直流 (DC)	DC: 0.9W
	交流 (AC)	AC: 1.2VA
吸合时间 Operate time		≤20ms
释放时间 Release time		≤20ms
介质耐压 Dielectric strength	同极触点之间 Between contacts	1000VAC/1min(漏电流1mA)
	异极触点之间 Between contacts (different pole)	1000VAC/1min(漏电流1mA)
	触点与线圈间 Between contacts and coil	1500VAC/1min(漏电流1mA)
绝缘电阻 Insulation resistance		≥1000m (500VDC)
环境温度 Ambient temperature		-25~+55°C
环境湿度 Ambient humidity		45%~75%RH
大气压力 Atmospheric pressure		86~106KPa
耐冲压 Resistance stamping		10G(正弦波半脉冲: 11ms)
耐振动 Vibration Resistance		10~55Hz 双振幅: 1.5mm
安装方式 Install model		PCB印刷板式, 插座式
重量 Weight		约35g
包装信息 Package	内盒数量 Inner Box Quantity	纸盒/20只每盒
	装箱数量 Carton Quantity	500只每箱
	外箱尺寸 Meas	长: 340 X 宽: 270 X 高: 350
	重量 Weight	净重: 15.85KG/每箱 毛重: 17.7KG/箱 外箱重量: 0.6KG 内盒重量: 0.05KG每盒



线圈参数

额定电压 DC(V)	额定电流 $\pm 10(\text{mA})$	线圈电阻 $\pm 10\%(\Omega)$	最大连续外加电压 (V)	吸合电压 (Max)	释放电压 (Min)	额定功耗 (W)
6	150	40	额定电压 $\times 110\%$	\leq 额定电压 75%	\geq 额定电压 10%	0.9
12	75	60				
24	37.5	640				
48	18.7	2560				
110	8	13444				
127	7	17921				
220	4	53777				

额定电压 AC(V)	额定电流 $\pm 10(\text{mA})$	线圈电阻 $\pm 10\%(\Omega)$	最大连续外加电压 (V)	吸合电压 (Max)	释放电压 (Min)	额定功耗 (W)
6	200	10.5	额定电压 $\times 110\%$	\leq 额定电压 80%	\geq 额定电压 30%	1.2
12	100	42				
24	50	168				
48	25	672				
110	10.9	3529				
220	5.4	14116				
380	3.1	42116				

外形安装尺寸图(mm)

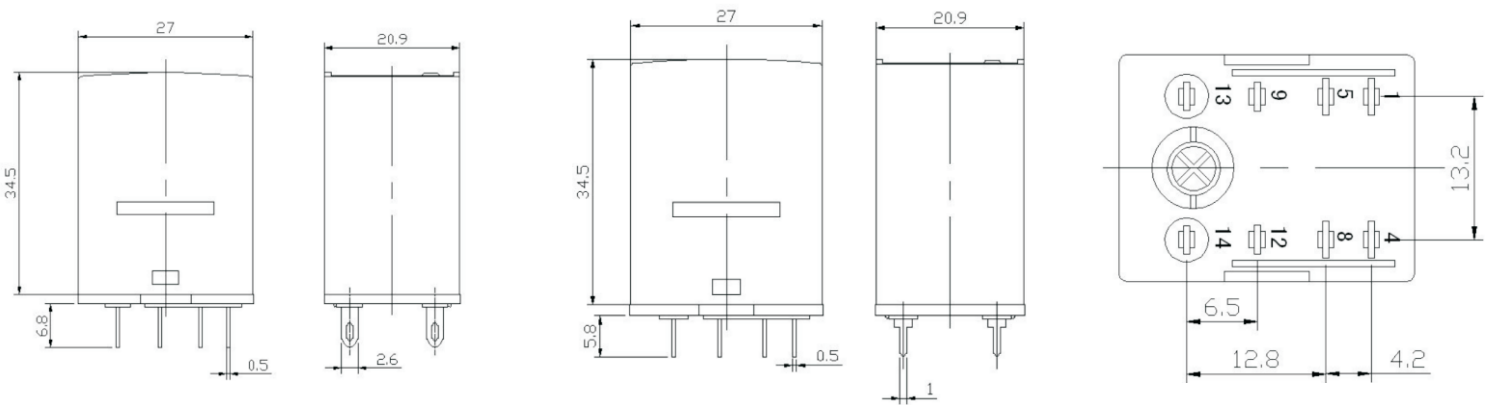

<外形图-插入式>

<外形图-PCB式>

<安装尺寸图>

曲线性能图

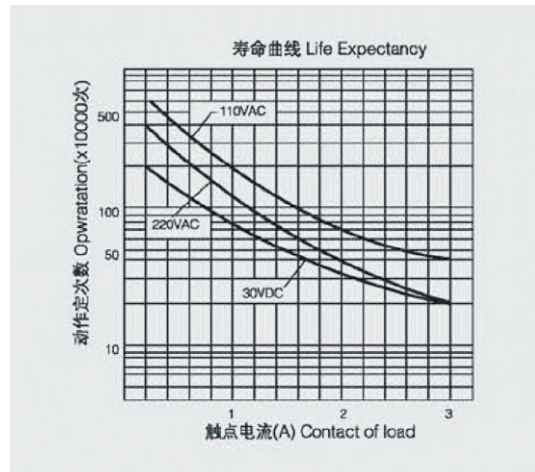
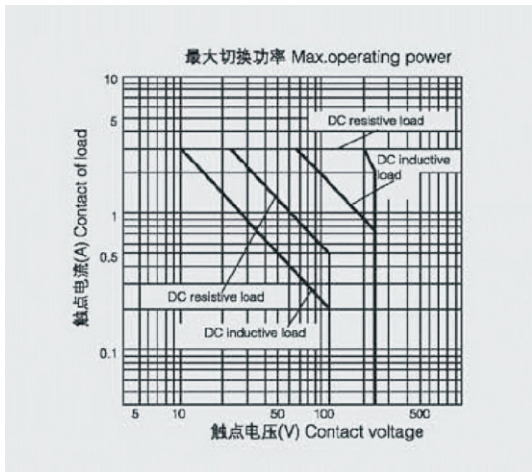



接线图

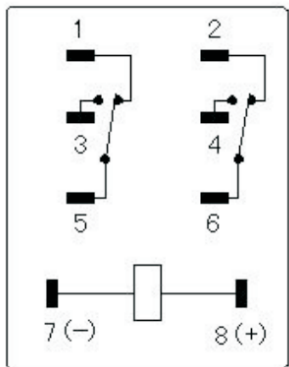

<2Z>

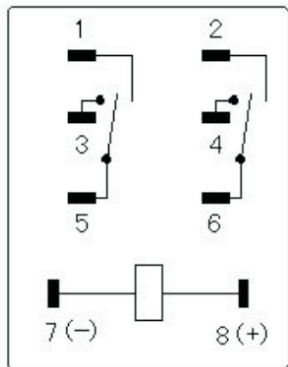

<2H>

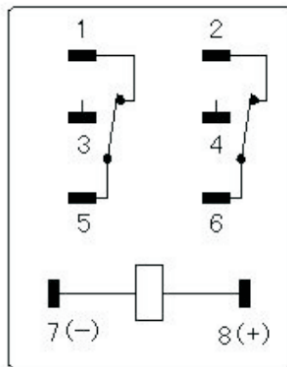

<2D>

LM2C-BL (带发光二极管)

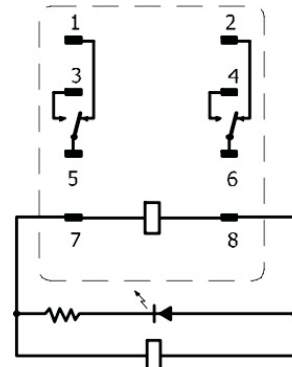

<底视图>

印字图



<印字图-顶部印字>

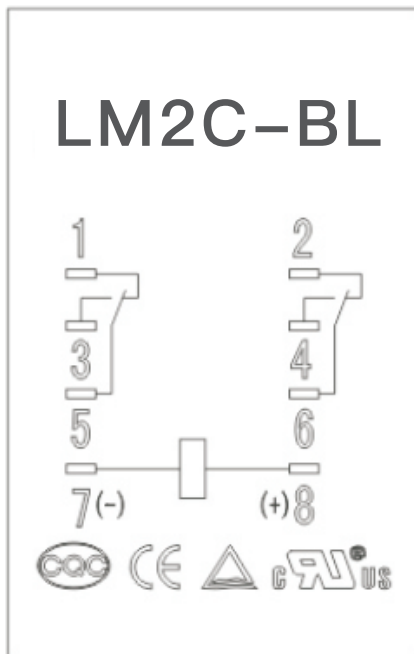

<印字图-背部印字>



连接插座

[LMS01-08P]

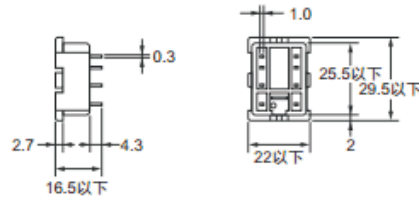
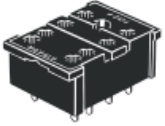

端子配置/内部连接图 (底视图)

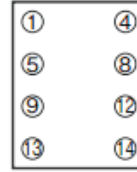

印刷电路板加工尺寸

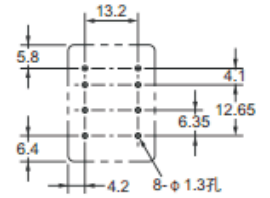

[LMS01-08AE]

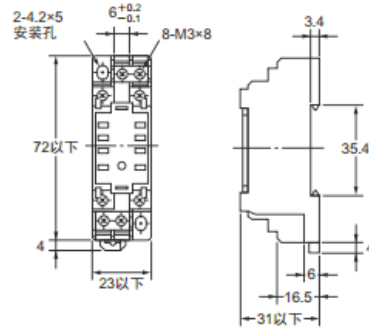
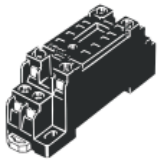

端子配置/内部连接图 (底视图)

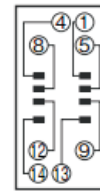

安装孔加工尺寸 (顶视图)

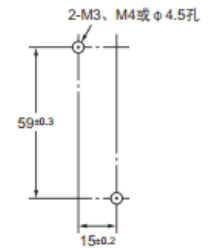

注：也可进行DIN导轨安装

[LMS02-08A]

外形图

接线图

安装孔尺寸

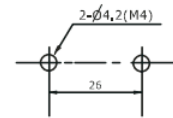
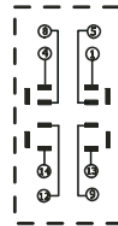
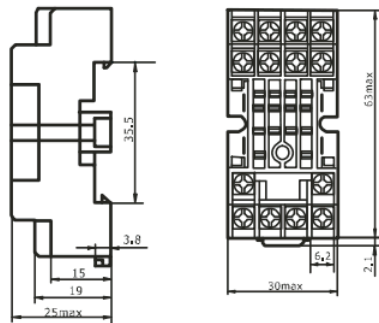

声明：

本产品规格书仅供客户使用参考，若有更改，恕不另行通知。
对瑞雷工业而言，不可能评定继电器在每个具体应用领域的所有性能参数要求，因而客户应根据具体的使用条件选择与之相匹配的产品，若有疑问，请与瑞雷工业联系以便获取更多的技术支持。