



MMBTSC3875

NPN Transistor

Features

- For Switching and AF Amplifier Applications.
- As Complementary Type of the PNP Transistor
MMBTSA1504 is Recommended.

SOT-23
(TO-236)

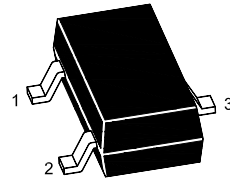

1.Base 2.Emitter 3.Collector

Marking:

MMBTSC3875O:ALO

MMBTSC3875Y:ALY

MMBTSC3875G:ALG

MMBTSC3875L:ALL

Absolute Maximum Ratings

Ratings at 25°C ambient temperature unless otherwise specified.

Parameter	Symbol	Value	Unit
Collector Base Voltage	V_{CBO}	60	V
Collector Emitter Voltage	V_{CEO}	50	V
Emitter Base Voltage	V_{EBO}	5	V
Collector Current	I_C	150	mA
Power Dissipation	P_D	150	mW
Junction Temperature	T_J	150	°C
Storage Temperature Range	T_{STG}	-55 to 150	°C



Electrical Characteristics

Ratings at 25°C ambient temperature unless otherwise specified.

Parameter	Symbol	Min.	Typ.	Max.	Unit
DC Current Gain at $V_{CE} = 6\text{ V}$, $I_C = 2\text{ mA}$ Current Gain Group	O Y G L H_{FE}	70	-	140	
		120	-	240	
		200	-	400	
		350	-	700	
Collector Base Cutoff Current at $V_{CB} = 60\text{ V}$	I_{CBO}	-	-	100	nA
Emitter Base Cutoff Current at $V_{EB} = 5\text{ V}$	I_{EBO}	-	-	100	nA
Collector Base Breakdown Voltage at $I_C = 100\text{ }\mu\text{A}$	$V_{(BR)CBO}$	60	-	-	V
Collector Emitter Breakdown Voltage at $I_C = 1\text{ mA}$	$V_{(BR)CEO}$	50	-	-	V
Emitter Base Breakdown Voltage at $I_E = 100\text{ }\mu\text{A}$	$V_{(BR)EBO}$	5	-	-	V
Collector Emitter Saturation Voltage at $I_C = 100\text{ mA}$, $I_B = 10\text{ mA}$	$V_{CE(sat)}$	-	0.1	0.25	V
Base Emitter Saturation Voltage at $I_C = 100\text{ mA}$, $I_B = 10\text{ mA}$	$V_{BE(sat)}$	-	-	1	V
Transition Frequency at $V_{CE} = 10\text{ V}$, $I_C = 1\text{ mA}$	f_T	80	-	-	MHz
Collector Base Capacitance at $V_{CB} = 10\text{ V}$, $f = 1\text{ MHz}$	C_{ob}	-	-	3.5	pF



Electrical Characteristics Curves

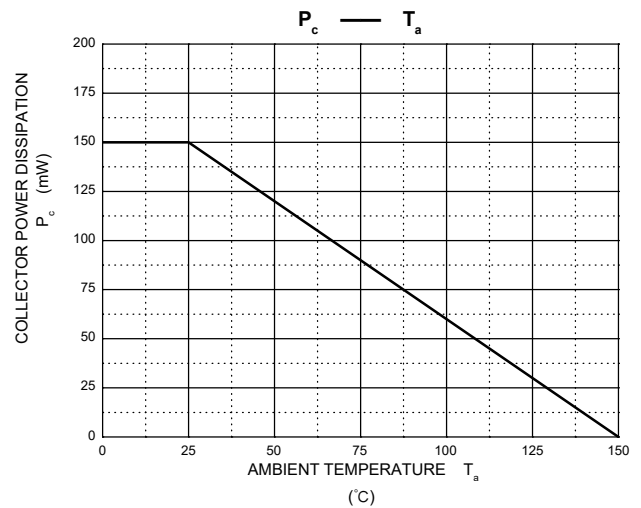
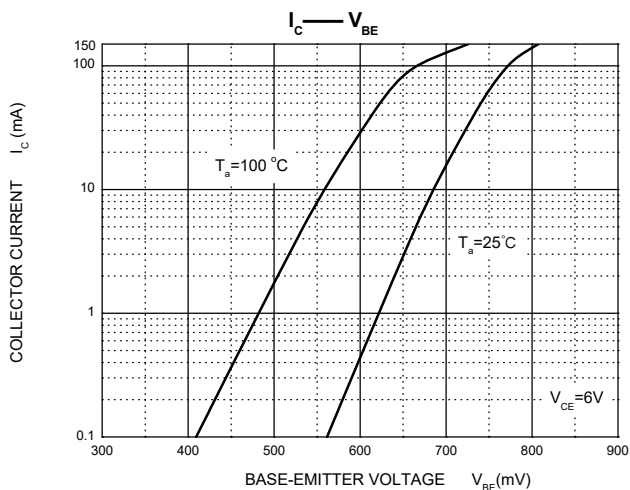
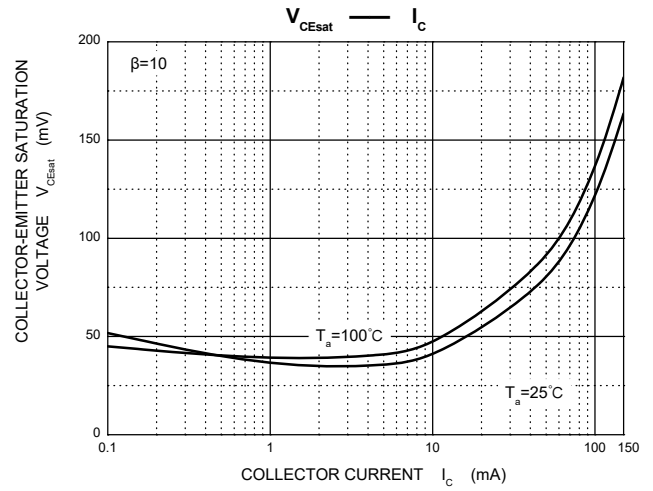
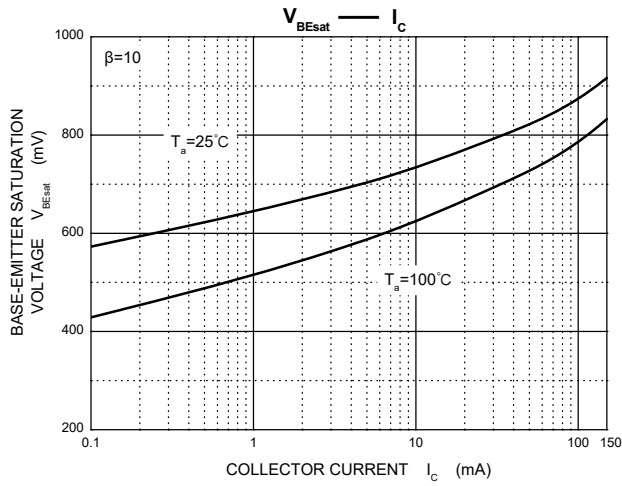
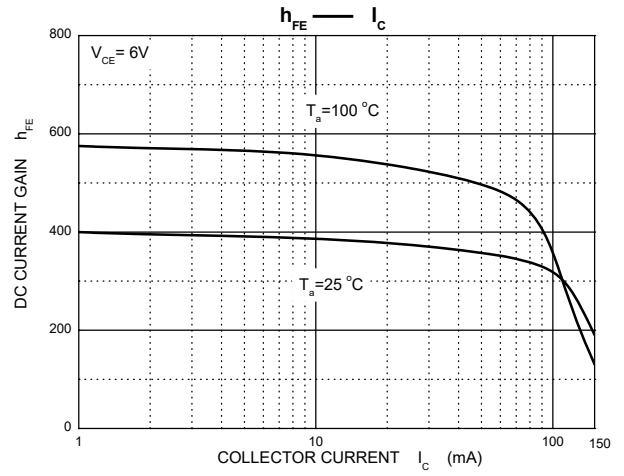
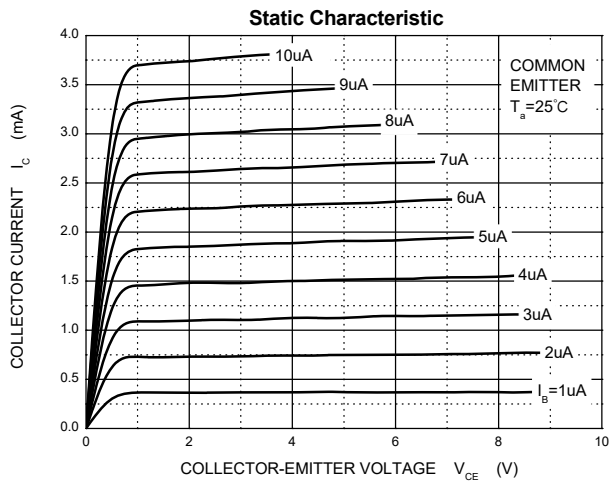



Package Outline(SOT-23)

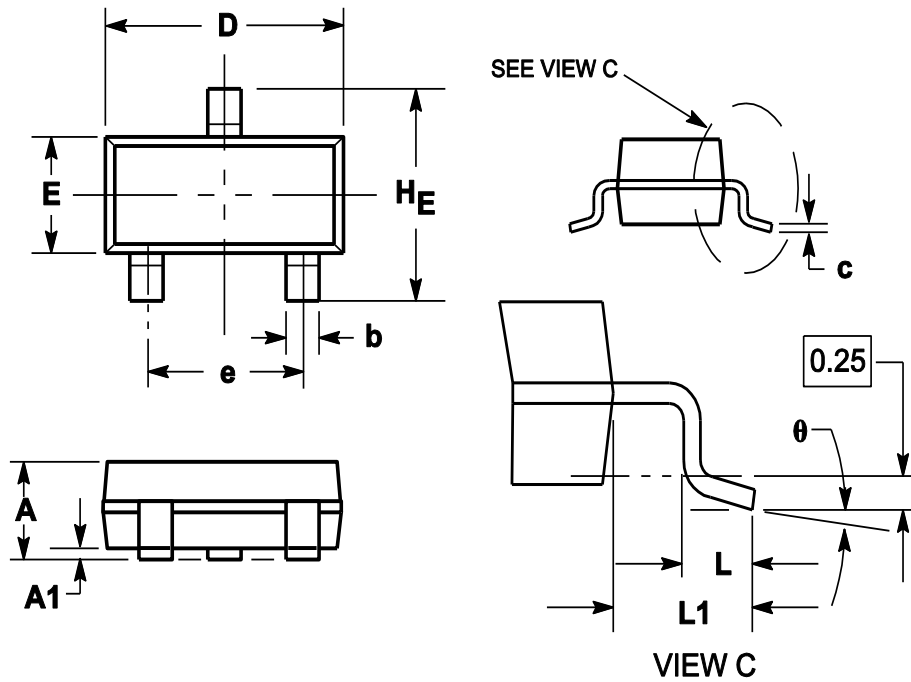

Symbol	Dimensions in millimeter		
	Min.	Typ.	Max.
A	0.900	1.025	1.150
A1	0.000	0.050	0.100
b	0.300	0.400	0.500
c	0.080	0.115	0.150
D	2.800	2.900	3.000
E	1.200	1.300	1.400
HE	2.250	2.400	2.550
e	1.800	1.900	2.000
L1	0.550REF		
L	0.300		0.500
θ	0°		8°

Ordering Information

Device	Package	Reel Dimension (inch)	Shipping
MMBTSC3875	SOT-23	7	3,000