

NPN Silicon Power Transistor

The transistor is subdivided into four groups, R, Q, P and E, according to its DC current gain.

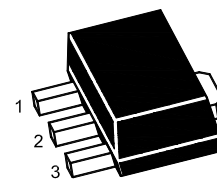

1.Base 2.Collector 3.Emitter
SOT-89 Plastic Package

Absolute Maximum Ratings ($T_a = 25^\circ\text{C}$)

Parameter	Symbol	Value	Unit
Collector to Base Voltage	V_{CBO}	40	V
Collector to Emitter Voltage	V_{CEO}	30	V
Emitter to Base Voltage	V_{EBO}	5	V
Collector Current	I_C	3	A
Peak Collector Current ($t = 10\text{ ms}$)	I_{CP}	7	A
Total power dissipation ($T_a = 25^\circ\text{C}$)	P_{tot}	1	W
Total power dissipation ($T_c = 25^\circ\text{C}$)	P_{tot}	10	W
Junction Temperature	T_j	150	$^\circ\text{C}$
Storage Temperature Range	T_{stg}	- 55 to + 150	$^\circ\text{C}$

Characteristics at $T_a = 25^\circ\text{C}$

Parameter	Symbol	Min.	Typ.	Max.	Unit
DC Current Gain at $V_{CE} = 2\text{ V}$, $I_C = 20\text{ mA}$ at $V_{CE} = 2\text{ V}$, $I_C = 1\text{ A}$ Current Gain Group	R	h_{FE}	30	-	-
	O	h_{FE}	60	-	120
	Y	h_{FE}	100	-	200
		h_{FE}	160	-	320
	GR	h_{FE}	200	-	400
Collector Base Cutoff Current at $V_{CB} = 30\text{ V}$	I_{CBO}	-	-	1	μA
Emitter Base Cutoff Current at $V_{EB} = 3\text{ V}$	I_{EBO}	-	-	1	μA
Collector Emitter Saturation Voltage at $I_C = 2\text{ A}$, $I_B = 0.2\text{ A}$	$V_{CE(sat)}$	-	-	0.5	V
Base Emitter Saturation Voltage at $I_C = 2\text{ A}$, $I_B = 0.2\text{ A}$	$V_{BE(sat)}$	-	-	2	V
Gain Bandwidth Product at $V_{CE} = 5\text{ V}$, $I_C = 0.1\text{ A}$	f_T	-	90	-	MHz
Output Capacitance at $V_{CB} = 10\text{ V}$, $f = 1\text{ MHz}$	C_{ob}	-	45	-	pF



TYPICAL CHARACTERISTICS (Ta=25°C)

TOTAL POWER DISSIPATION vs. AMBIENT TEMPERATURE

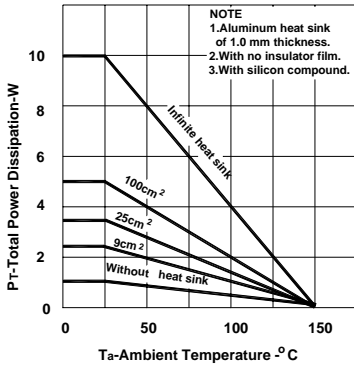

DERATING CURVES FOR ALL TYPES

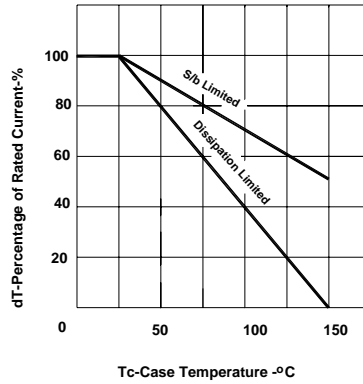

THERMAL RESISTANCE vs. PULSE WIDTH

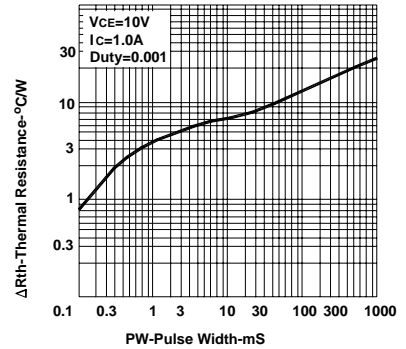

SAFE OPERATING AREAS

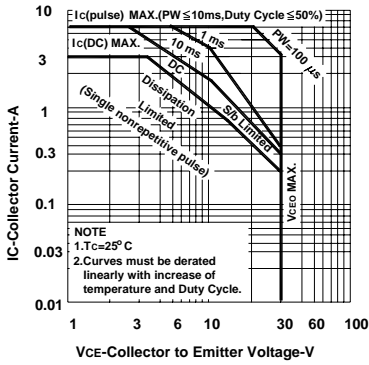

COLLECTOR CURRENT vs. COLLECTOR TO EMITTER VOLTAGE

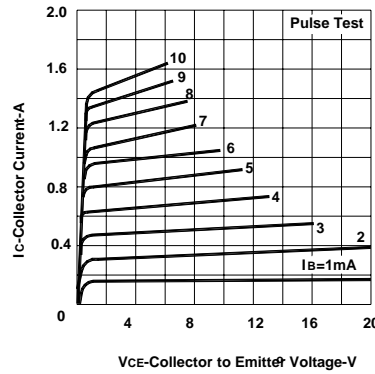

DC CURRENT GAIN, BASE TO EMITTER VOLTAGE vs. COLLECTOR CURRENT

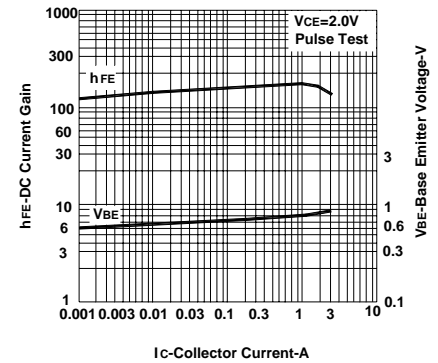

BASE AND COLLECTOR SATURATION VOLTAGE vs. COLLECTOR CURRENT

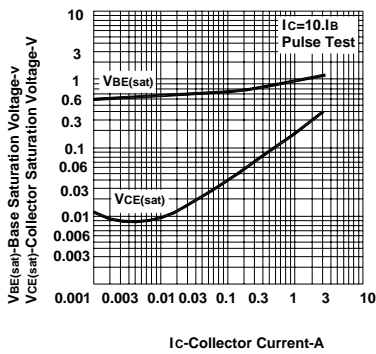

GAIN BANDWIDTH PRODUCT vs. COLLECTOR CURRENT

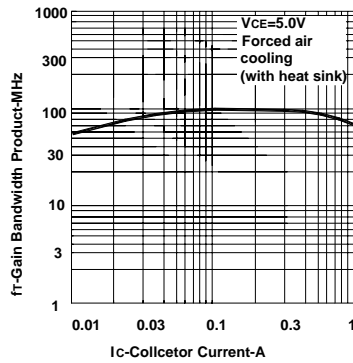

INPUT AND OUTPUT CAPACITANCE vs. REVERSE VOLTAGE

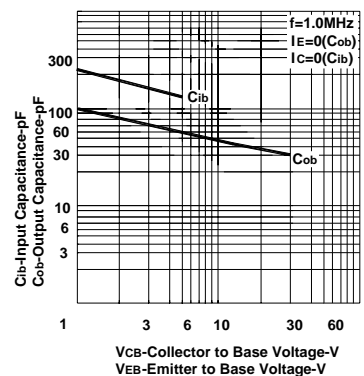

SOT-89 PACKAGE OUTLINE

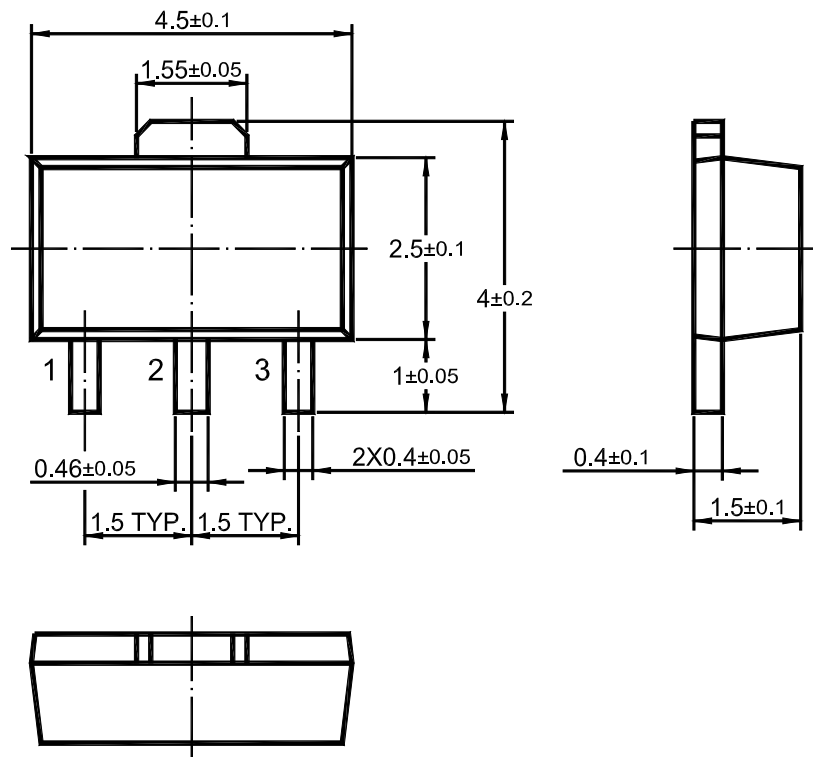

Dimensions in mm

