

74LVC541A-Q100

Octal buffer/line driver with 5 V tolerant inputs/outputs;
3-state

Rev. 2 — 4 March 2013

Product data sheet

1. General description

The 74LVC541A-Q100 is an octal non-inverting buffer/line driver with 5 V tolerant inputs and outputs. The output enable inputs $\overline{OE}1$ and $\overline{OE}2$ control the 3-state outputs.

This device is fully specified for partial power-down applications using I_{OFF} . The I_{OFF} circuitry disables the output, preventing the damaging backflow current through the device when it is powered down.

Inputs can be driven from either 3.3 V or 5 V devices. When disabled, up to 5.5 V can be applied to the outputs. These features allow the use of these devices as translators in mixed 3.3 V and 5 V applications.

This product has been qualified to the Automotive Electronics Council (AEC) standard Q100 (Grade 1) and is suitable for use in automotive applications.

2. Features and benefits

- Automotive product qualification in accordance with AEC-Q100 (Grade 1)
 - ◆ Specified from $-40\text{ }^{\circ}\text{C}$ to $+85\text{ }^{\circ}\text{C}$ and from $-40\text{ }^{\circ}\text{C}$ to $+125\text{ }^{\circ}\text{C}$
- 5 V tolerant inputs for interfacing with 5 V logic
- Wide supply voltage range from 1.2 V to 3.6 V
- CMOS low power consumption
- Direct interface with TTL levels
- Complies with JEDEC standard:
 - ◆ JESD8-7A (1.65 V to 1.95 V)
 - ◆ JESD8-5A (2.3 V to 2.7 V)
 - ◆ JESD8-C/JESD36 (2.7 V to 3.6 V)
- ESD protection:
 - ◆ MIL-STD-883, method 3015 exceeds 2000 V
 - ◆ HBM JESD22-A114F exceeds 2000 V
 - ◆ MM JESD22-A115-A exceeds 200 V ($C = 200\text{ pF}$, $R = 0\text{ }\Omega$)

3. Ordering information

Table 1. Ordering information

| Type number | Package | | | Version |
|------------------|-------------------|----------|--|----------|
| | Temperature range | Name | Description | |
| 74LVC541AD-Q100 | -40 °C to +125 °C | SO20 | plastic small outline package; 20 leads; body width 7.5 mm | SOT163-1 |
| 74LVC541APW-Q100 | -40 °C to +125 °C | TSSOP20 | plastic thin shrink small outline package; 20 leads; body width 4.4 mm | SOT360-1 |
| 74LVC541ABQ-Q100 | -40 °C to +125 °C | DHVQFN20 | plastic dual in-line compatible thermal enhanced very thin quad flat package; no leads; 20 terminals; body 2.5 × 4.5 × 0.85 mm | SOT764-1 |

4. Functional diagram

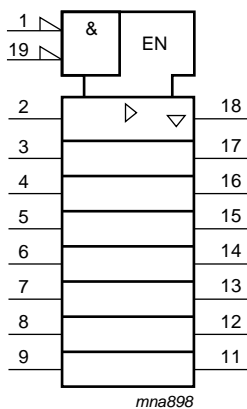

Fig 1. IEC logic symbol

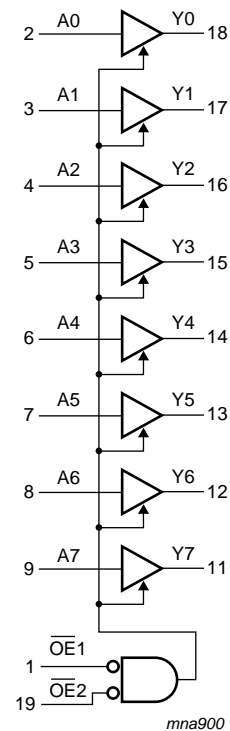
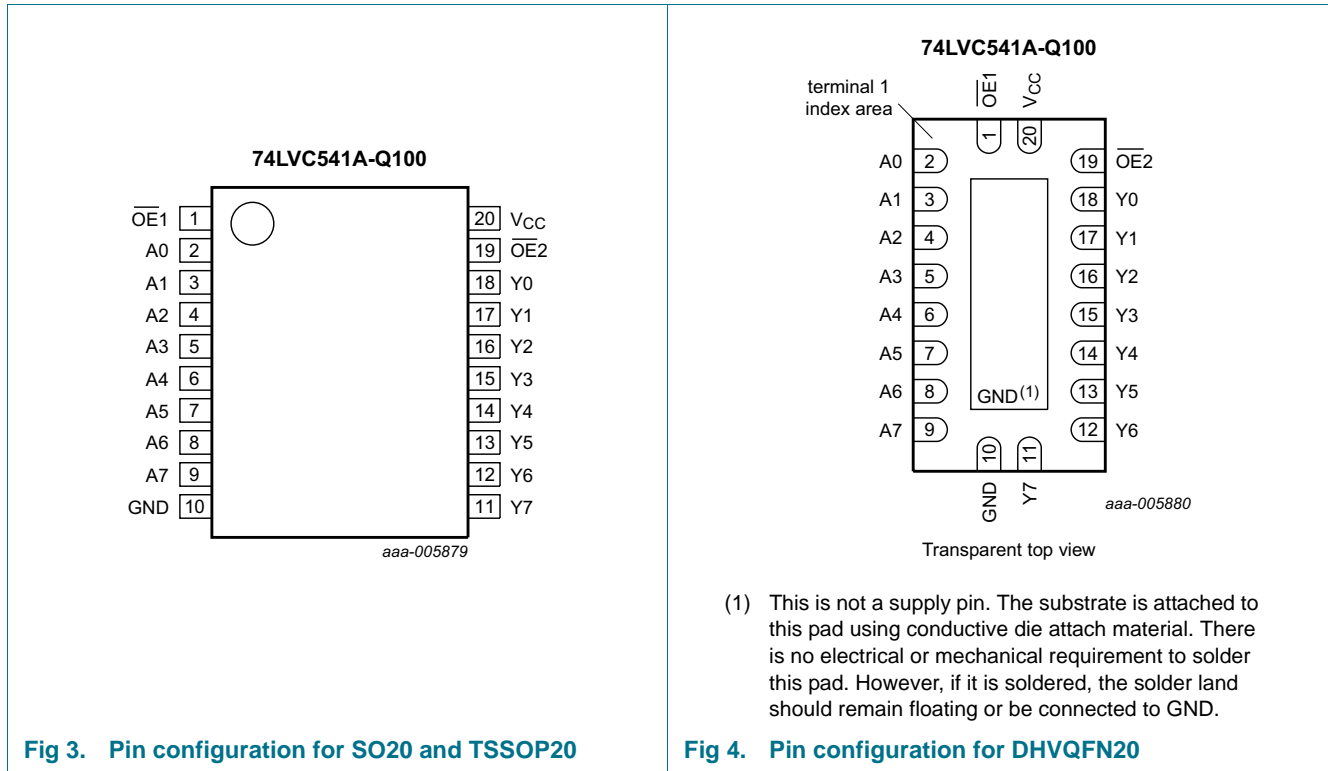

Fig 2. Functional diagram

5. Pinning information

5.1 Pinning



5.2 Pin description

Table 2. Pin description

| Symbol | Pin | Description |
|------------------|--------------------------------|----------------------------------|
| $\overline{OE1}$ | 1 | output enable input (active LOW) |
| A[0:7] | 2, 3, 4, 5, 6, 7, 8, 9 | data input |
| GND | 10 | ground (0 V) |
| Y[0:7] | 18, 17, 16, 15, 14, 13, 12, 11 | bus output |
| $\overline{OE2}$ | 19 | output enable input (active LOW) |
| V _{CC} | 20 | supply voltage |

6. Functional description

Table 3. Functional table^[1]

| Input | | | Output | |
|-------|-----|----|--------|--|
| OE1 | OE2 | An | Yn | |
| L | L | L | L | |
| L | L | H | H | |
| X | H | X | Z | |
| H | X | X | Z | |

- [1] H = HIGH voltage level
 L = LOW voltage level
 X = don't care
 Z = high-impedance OFF-state

7. Limiting values

Table 4. Limiting values

In accordance with the Absolute Maximum Rating System (IEC 60134). Voltages are referenced to GND (ground = 0 V).

| Symbol | Parameter | Conditions | Min | Max | Unit |
|-----------|-------------------------|-------------------------------|----------|----------------|------|
| V_{CC} | supply voltage | | -0.5 | +6.5 | V |
| I_{IK} | input clamping current | $V_I < 0$ V | -50 | - | mA |
| V_I | input voltage | | [1] -0.5 | +5.5 | V |
| I_{OK} | output clamping current | $V_O > V_{CC}$ or $V_O < 0$ V | - | ±50 | mA |
| V_O | output voltage | output HIGH or LOW state | [2] -0.5 | $V_{CC} + 0.5$ | V |
| | | output 3-state or power-down | [2] -0.5 | +6.5 | V |
| I_O | output current | $V_O = 0$ V to V_{CC} | - | ±50 | mA |
| I_{CC} | supply current | | - | 100 | mA |
| I_{GND} | ground current | | -100 | - | mA |
| T_{stg} | storage temperature | | -60 | +150 | °C |
| P_{tot} | total power dissipation | $T_{amb} = -40$ °C to +125 °C | [3] - | 500 | mW |

- [1] The minimum input voltage ratings may be exceeded if the input current ratings are observed.
 [2] The output voltage ratings may be exceeded if the output current ratings are observed.
 [3] For SO20 packages: above 70 °C the value of P_{tot} derates linearly with 8 mW/K.
 For TSSOP20 packages: above 60 °C the value of P_{tot} derates linearly with 5.5 mW/K.
 For DHVQFN20 packages: above 60 °C the value of P_{tot} derates linearly with 4.5 mW/K.

8. Recommended operating conditions

Table 5. Recommended operating conditions

| Symbol | Parameter | Conditions | Min | Typ | Max | Unit |
|---------------------|-------------------------------------|--|------|-----|----------|------|
| V_{CC} | supply voltage | | 1.65 | - | 3.6 | V |
| | | functional | 1.2 | - | - | V |
| V_I | input voltage | | 0 | - | 5.5 | V |
| V_O | output voltage | output HIGH or LOW state | 0 | - | V_{CC} | V |
| | | output 3-state | 0 | - | 5.5 | V |
| T_{amb} | ambient temperature | | -40 | - | +125 | °C |
| $\Delta t/\Delta V$ | input transition rise and fall rate | $V_{CC} = 2.3 \text{ V to } 2.7 \text{ V}$ | 0 | - | 20 | ns/V |
| | | $V_{CC} = 2.7 \text{ V to } 3.6 \text{ V}$ | 0 | - | 10 | ns/V |

9. Static characteristics

Table 6. Static characteristics

At recommended operating conditions. Voltages are referenced to GND (ground = 0 V).

| Symbol | Parameter | Conditions | -40 °C to +85 °C | | | -40 °C to +125 °C | | Unit |
|----------|---------------------------|---|----------------------|--------------------|----------------------|----------------------|----------------------|------|
| | | | Min | Typ ^[1] | Max | Min | Max | |
| V_{IH} | HIGH-level input voltage | $V_{CC} = 1.2 \text{ V}$ | 1.08 | - | - | 1.08 | - | V |
| | | $V_{CC} = 1.65 \text{ V to } 1.95 \text{ V}$ | $0.65 \times V_{CC}$ | - | - | $0.65 \times V_{CC}$ | - | V |
| | | $V_{CC} = 2.3 \text{ V to } 2.7 \text{ V}$ | 1.7 | - | - | 1.7 | - | V |
| | | $V_{CC} = 2.7 \text{ V to } 3.6 \text{ V}$ | 2.0 | - | - | 2.0 | - | V |
| V_{IL} | LOW-level input voltage | $V_{CC} = 1.2 \text{ V}$ | - | - | 0.12 | - | 0.12 | V |
| | | $V_{CC} = 1.65 \text{ V to } 1.95 \text{ V}$ | - | - | $0.35 \times V_{CC}$ | - | $0.35 \times V_{CC}$ | V |
| | | $V_{CC} = 2.3 \text{ V to } 2.7 \text{ V}$ | - | - | 0.7 | - | 0.7 | V |
| | | $V_{CC} = 2.7 \text{ V to } 3.6 \text{ V}$ | - | - | 0.8 | - | 0.8 | V |
| V_{OH} | HIGH-level output voltage | $V_I = V_{IH} \text{ or } V_{IL}$ | | | | | | |
| | | $I_O = -100 \mu\text{A}; V_{CC} = 1.65 \text{ V to } 3.6 \text{ V}$ | $V_{CC} - 0.2$ | - | - | $V_{CC} - 0.3$ | - | V |
| | | $I_O = -4 \text{ mA}; V_{CC} = 1.65 \text{ V}$ | 1.2 | - | - | 1.05 | - | V |
| | | $I_O = -8 \text{ mA}; V_{CC} = 2.3 \text{ V}$ | 1.8 | - | - | 1.65 | - | V |
| | | $I_O = -12 \text{ mA}; V_{CC} = 2.7 \text{ V}$ | 2.2 | - | - | 2.05 | - | V |
| | | $I_O = -18 \text{ mA}; V_{CC} = 3.0 \text{ V}$ | 2.4 | - | - | 2.25 | - | V |
| | | $I_O = -24 \text{ mA}; V_{CC} = 3.0 \text{ V}$ | 2.2 | - | - | 2.0 | - | V |
| V_{OL} | LOW-level output voltage | $V_I = V_{IH} \text{ or } V_{IL}$ | | | | | | |
| | | $I_O = 100 \mu\text{A}; V_{CC} = 1.65 \text{ V to } 3.6 \text{ V}$ | - | - | 0.2 | - | 0.3 | V |
| | | $I_O = 4 \text{ mA}; V_{CC} = 1.65 \text{ V}$ | - | - | 0.45 | - | 0.65 | V |
| | | $I_O = 8 \text{ mA}; V_{CC} = 2.3 \text{ V}$ | - | - | 0.6 | - | 0.8 | V |
| | | $I_O = 12 \text{ mA}; V_{CC} = 2.7 \text{ V}$ | - | - | 0.4 | - | 0.6 | V |
| | | $I_O = 24 \text{ mA}; V_{CC} = 3.0 \text{ V}$ | - | - | 0.55 | - | 0.8 | V |

Table 6. Static characteristics ...continued

At recommended operating conditions. Voltages are referenced to GND (ground = 0 V).

| Symbol | Parameter | Conditions | -40 °C to +85 °C | | | -40 °C to +125 °C | | Unit |
|------------------|---------------------------|---|------------------|--------------------|-----|-------------------|------|------|
| | | | Min | Typ ^[1] | Max | Min | Max | |
| I _I | input leakage current | V _I = 5.5 V or GND; V _{CC} = 3.6 V | - | ±0.1 | ±5 | - | ±20 | μA |
| I _{OZ} | OFF-state output current | V _I = V _{IH} or V _{IL} ; V _O = 5.5 V or GND; V _{CC} = 3.6 V | - | ±0.1 | ±5 | - | ±20 | μA |
| I _{OFF} | power-off leakage current | V _I or V _O = 5.5 V; V _{CC} = 0.0 V | - | ±0.1 | ±10 | - | ±20 | μA |
| I _{CC} | supply current | V _I = V _{CC} or GND; I _O = 0 A; V _{CC} = 3.6 V | - | 0.1 | 10 | - | 40 | μA |
| ΔI _{CC} | additional supply current | per input pin; V _I = V _{CC} - 0.6 V; I _O = 0 A; V _{CC} = 2.7 V to 3.6 V | - | 5 | 500 | - | 5000 | μA |
| C _I | input capacitance | | - | 5.0 | - | - | - | pF |

[1] All typical values are measured at V_{CC} = 3.3 V (unless stated otherwise) and T_{amb} = 25 °C.

10. Dynamic characteristics

Table 7. Dynamic characteristicsVoltages are referenced to GND (ground = 0 V). For test circuit see [Figure 7](#).

| Symbol | Parameter | Conditions | -40 °C to +85 °C | | | -40 °C to +125 °C | | Unit |
|------------------|-------------------|---|------------------|--------------------|------|-------------------|------|------|
| | | | Min | Typ ^[1] | Max | Min | Max | |
| t _{pd} | propagation delay | An to Y _n ; see Figure 5 ^[2] | | | | | | |
| | | V _{CC} = 1.2 V | - | 14.0 | - | - | - | ns |
| | | V _{CC} = 1.65 V to 1.95 V | 1.5 | 6.5 | 13.8 | 1.5 | 16.0 | ns |
| | | V _{CC} = 2.3 V to 2.7 V | 1.0 | 3.5 | 6.8 | 1.0 | 7.9 | ns |
| | | V _{CC} = 2.7 V | 1.5 | 3.5 | 5.6 | 1.5 | 7.0 | ns |
| t _{en} | enable time | $\overline{\text{OEn}}$ to Y _n ; see Figure 6 ^[2] | | | | | | |
| | | V _{CC} = 1.2 V | - | 20.0 | - | - | - | ns |
| | | V _{CC} = 1.65 V to 1.95 V | 1.8 | 7.7 | 16.0 | 1.8 | 18.5 | ns |
| | | V _{CC} = 2.3 V to 2.7 V | 1.5 | 4.3 | 8.8 | 1.5 | 10.2 | ns |
| | | V _{CC} = 2.7 V | 1.5 | 4.4 | 7.5 | 1.5 | 9.5 | ns |
| t _{dis} | disable time | $\overline{\text{OEn}}$ to Y _n ; see Figure 6 ^[2] | | | | | | |
| | | V _{CC} = 1.2 V | - | 11.0 | - | - | - | ns |
| | | V _{CC} = 1.65 V to 1.95 V | 3.0 | 4.9 | 10.3 | 3.0 | 11.9 | ns |
| | | V _{CC} = 2.3 V to 2.7 V | 1.0 | 2.7 | 5.9 | 1.0 | 6.8 | ns |
| | | V _{CC} = 2.7 V | 1.5 | 3.7 | 7.0 | 1.5 | 9.0 | ns |
| t _{dis} | disable time | V _{CC} = 3.0 V to 3.6 V | 1.0 | 3.3 | 6.0 | 1.0 | 7.5 | ns |

Table 7. Dynamic characteristics ...continued

Voltages are referenced to GND (ground = 0 V). For test circuit see [Figure 7](#).

| Symbol | Parameter | Conditions | -40 °C to +85 °C | | | -40 °C to +125 °C | | Unit |
|-----------------|-------------------------------|--|------------------|--------------------|-----|-------------------|-----|------|
| | | | Min | Typ ^[1] | Max | Min | Max | |
| C _{PD} | power dissipation capacitance | per input; V _I = GND to V _{CC} | | | | | | |
| | | V _{CC} = 1.65 V to 1.95 V | - | 7.7 | - | - | - | pF |
| | | V _{CC} = 2.3 V to 2.7 V | - | 11.3 | - | - | - | pF |
| | | V _{CC} = 3.0 V to 3.6 V | - | 14.4 | - | - | - | pF |

- [1] Typical values are measured at T_{amb} = 25 °C and V_{CC} = 1.2 V, 1.8 V, 2.5 V, 2.7 V, and 3.3 V respectively.
- [2] t_{pd} is the same as t_{PLH} and t_{PHL}.
t_{en} is the same as t_{PZL} and t_{PZH}.
t_{dis} is the same as t_{PLZ} and t_{PHZ}.
- [3] Skew between any two outputs of the same package switching in the same direction. This parameter is guaranteed by design.
- [4] C_{PD} is used to determine the dynamic power dissipation (P_D in μW).
P_D = C_{PD} × V_{CC}² × f_i × N + Σ(C_L × V_{CC}² × f_o) where:
f_i = input frequency in MHz; f_o = output frequency in MHz
C_L = output load capacitance in pF
V_{CC} = supply voltage in Volts
N = number of inputs switching
Σ(C_L × V_{CC}² × f_o) = sum of the outputs.

11. AC waveforms

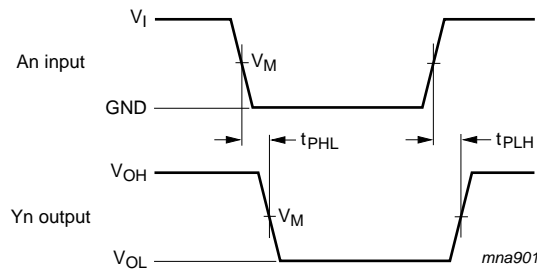

V_M = 1.5 V at V_{CC} ≥ 2.7 V.

V_M = 0.5 × V_{CC} at V_{CC} < 2.7 V.

V_{OL} and V_{OH} are typical output voltage levels that occur with the output load.

Fig 5. Input (An) to output (Yn) propagation delays

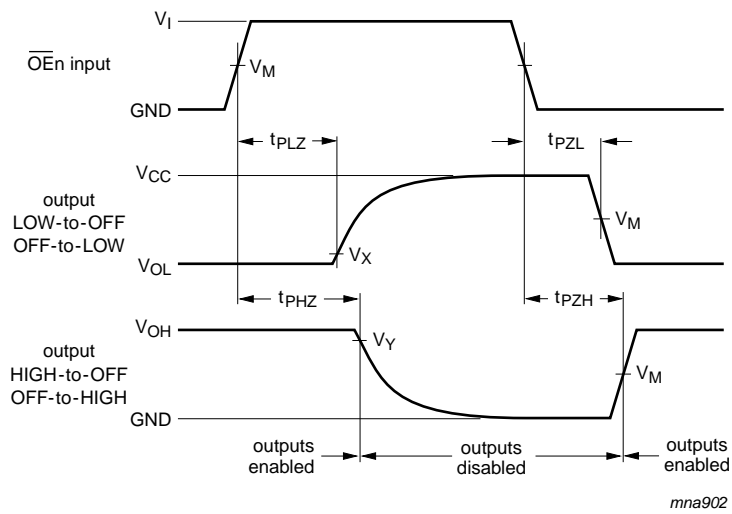

$V_M = 1.5 \text{ V}$ at $V_{CC} \geq 2.7 \text{ V}$.

$V_M = 0.5 \times V_{CC}$ at $V_{CC} < 2.7 \text{ V}$.

$V_X = V_{OL} + 0.3 \text{ V}$ at $V_{CC} \geq 2.7 \text{ V}$.

$V_X = V_{OL} + 0.15 \text{ V}$ at $V_{CC} < 2.7 \text{ V}$.

$V_Y = V_{OH} - 0.3 \text{ V}$ at $V_{CC} \geq 2.7 \text{ V}$.

$V_Y = V_{OH} - 0.15 \text{ V}$ at $V_{CC} < 2.7 \text{ V}$.

V_{OL} and V_{OH} are typical output voltage levels that occur with the output load.

Fig 6. 3-state enable and disable times

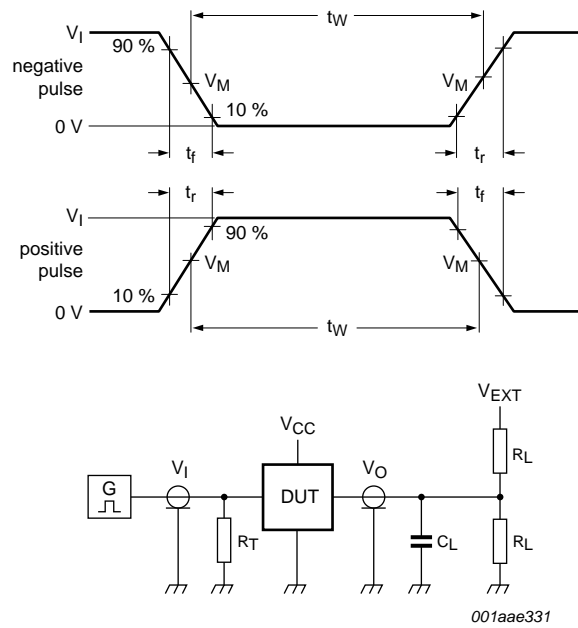

Test data is given in [Table 8](#).

Definitions for test circuit:

R_L = Load resistance.

C_L = Load capacitance including jig and probe capacitance.

R_T = Termination resistance should be equal to output impedance Z_o of the pulse generator.

V_{EXT} = External voltage for measuring switching times.

Fig 7. Test circuit for measuring switching times

Table 8. Test data

| Supply voltage | Input | | Load | | V_{EXT} | | |
|------------------|----------|---------------|-------|--------------|--------------------|--------------------|--------------------|
| | V_I | t_r, t_f | C_L | R_L | t_{PLH}, t_{PHL} | t_{PLZ}, t_{PZL} | t_{PHZ}, t_{PZH} |
| 1.2 V | V_{CC} | ≤ 2 ns | 30 pF | 1 k Ω | open | $2 \times V_{CC}$ | GND |
| 1.65 V to 1.95 V | V_{CC} | ≤ 2 ns | 30 pF | 1 k Ω | open | $2 \times V_{CC}$ | GND |
| 2.3 V to 2.7 V | V_{CC} | ≤ 2 ns | 30 pF | 500 Ω | open | $2 \times V_{CC}$ | GND |
| 2.7 V | 2.7 V | ≤ 2.5 ns | 50 pF | 500 Ω | open | $2 \times V_{CC}$ | GND |
| 3.0 V to 3.6 V | 2.7 V | ≤ 2.5 ns | 50 pF | 500 Ω | open | $2 \times V_{CC}$ | GND |

12. Package outline

SO20: plastic small outline package; 20 leads; body width 7.5 mm

SOT163-1

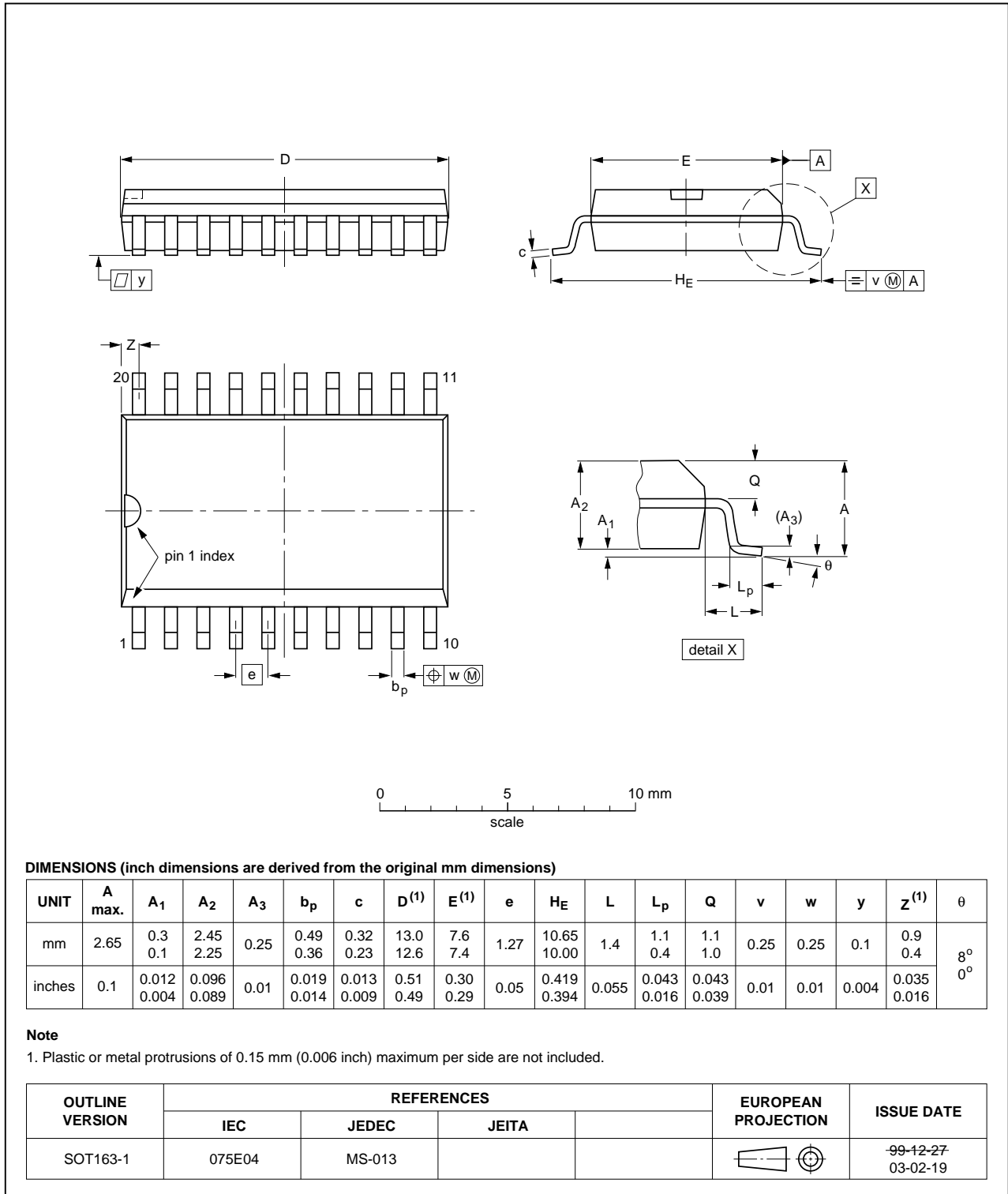

Fig 8. Package outline SOT163-1 (SO20)

TSSOP20: plastic thin shrink small outline package; 20 leads; body width 4.4 mm

SOT360-1

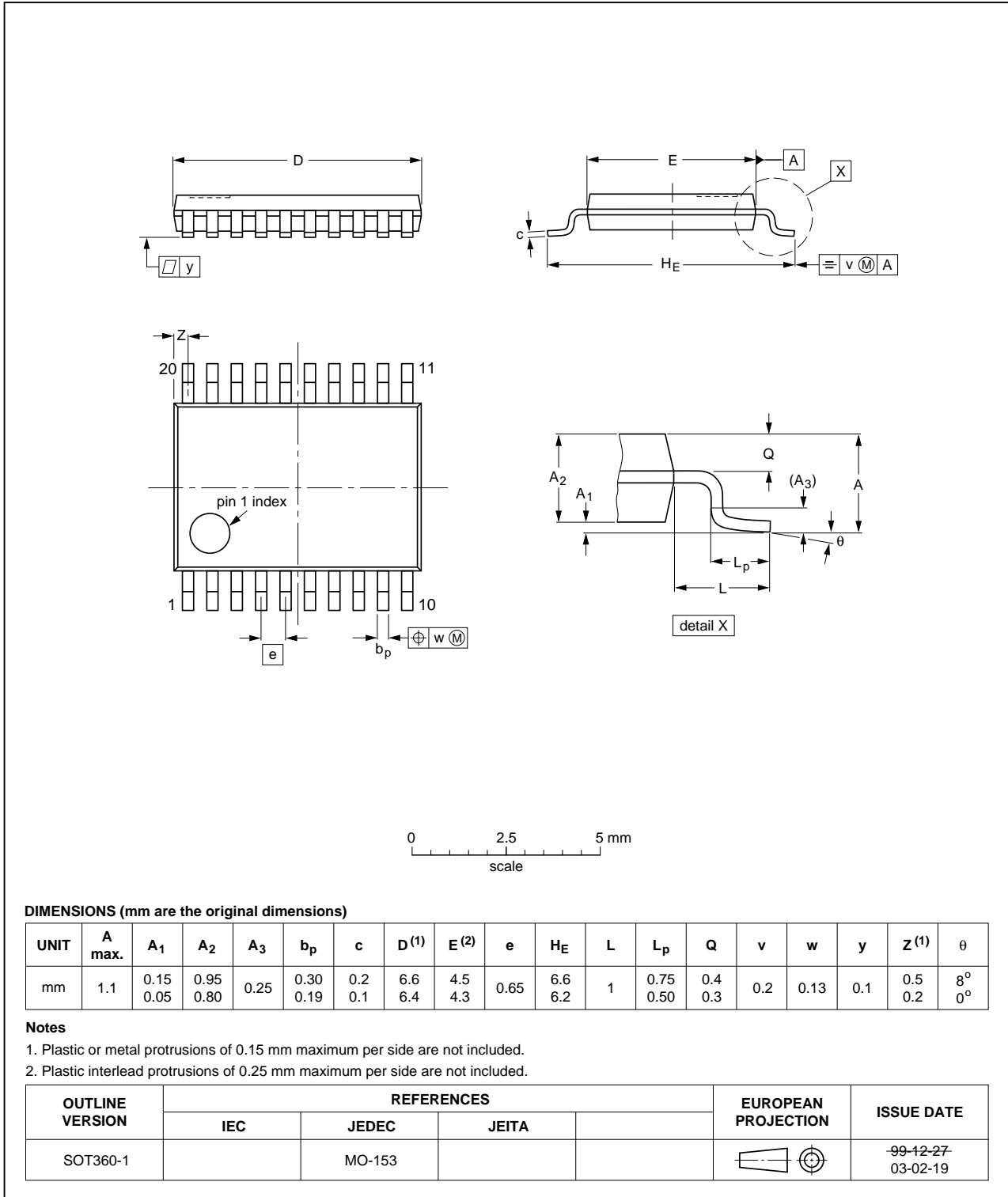

Fig 9. Package outline SOT360-1 (TSSOP20)

DHVQFN20: plastic dual in-line compatible thermal enhanced very thin quad flat package; no leads; 20 terminals; body 2.5 x 4.5 x 0.85 mm

SOT764-1

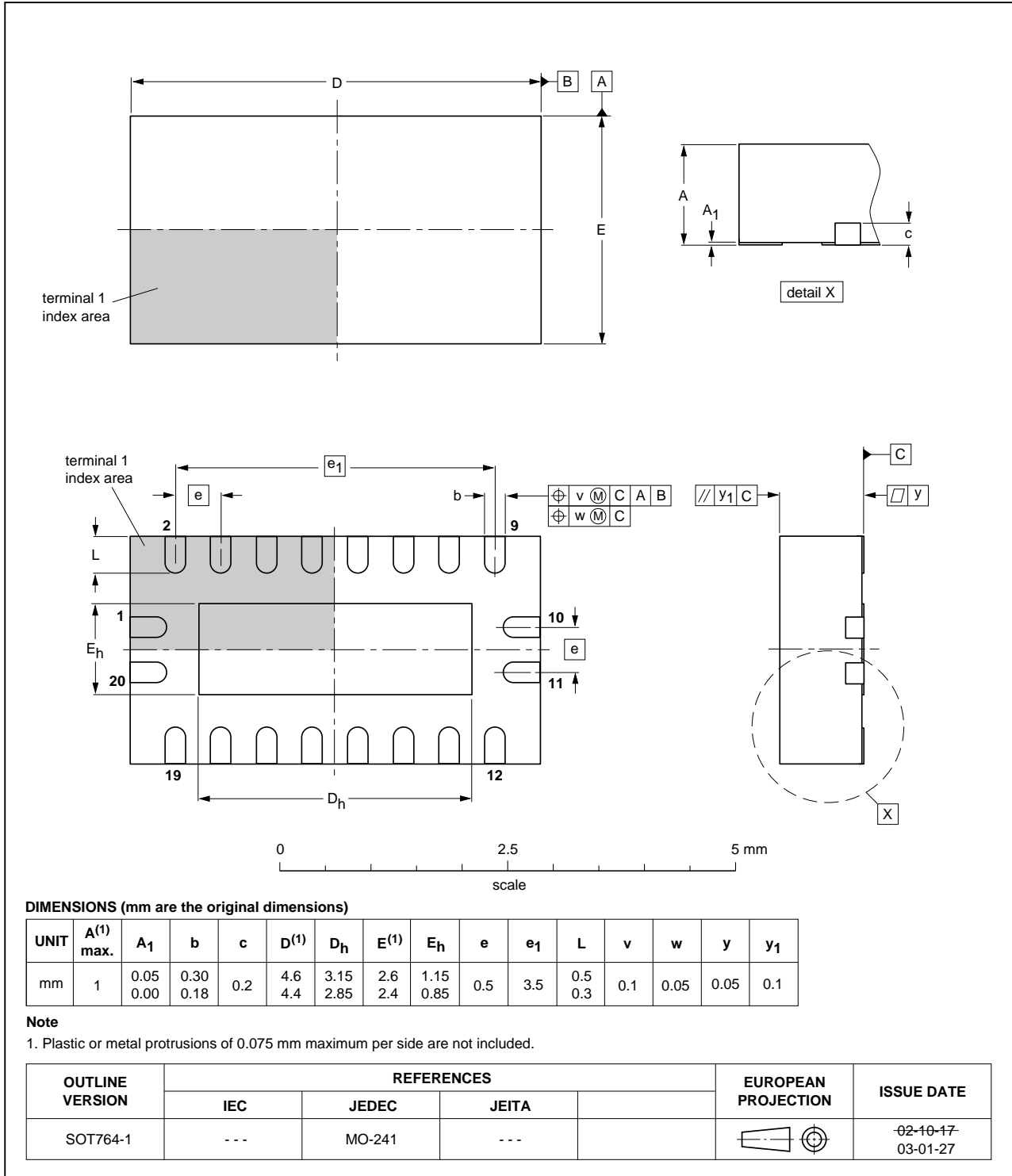

Fig 10. Package outline SOT764-1 (DHVQFN20)

13. Abbreviations

Table 9. Abbreviations

| Acronym | Description |
|---------|-----------------------------|
| CDM | Charged Device Model |
| DUT | Device Under Test |
| ESD | ElectroStatic Discharge |
| MM | Machine Model |
| HBM | Human Body Model |
| TTL | Transistor-Transistor Logic |
| MIL | Military |

14. Revision history

Table 10. Revision history

| Document ID | Release date | Data sheet status | Change notice | Supersedes |
|--------------------|---|--------------------|---------------|--------------------|
| 74LVC541A_Q100 v.2 | 20130304 | Product data sheet | - | 74LVC541A_Q100 v.1 |
| Modifications: | • Changed interlacing into interfacing (errata) in features list. | | | |
| 74LVC541A_Q100 v.1 | 20130219 | Product data sheet | - | - |

15. Legal information

15.1 Data sheet status

| Document status ^{[1][2]} | Product status ^[3] | Definition |
|-----------------------------------|-------------------------------|---|
| Objective [short] data sheet | Development | This document contains data from the objective specification for product development. |
| Preliminary [short] data sheet | Qualification | This document contains data from the preliminary specification. |
| Product [short] data sheet | Production | This document contains the product specification. |

[1] Please consult the most recently issued document before initiating or completing a design.

[2] The term 'short data sheet' is explained in section "Definitions".

[3] The product status of device(s) described in this document may have changed since this document was published and may differ in case of multiple devices. The latest product status information is available on the Internet at URL <http://www.nexperia.com>.

15.2 Definitions

Draft — The document is a draft version only. The content is still under internal review and subject to formal approval, which may result in modifications or additions. Nexperia does not give any representations or warranties as to the accuracy or completeness of information included herein and shall have no liability for the consequences of use of such information.

Short data sheet — A short data sheet is an extract from a full data sheet with the same product type number(s) and title. A short data sheet is intended for quick reference only and should not be relied upon to contain detailed and full information. For detailed and full information see the relevant full data sheet, which is available on request via the local Nexperia sales office. In case of any inconsistency or conflict with the short data sheet, the full data sheet shall prevail.

Product specification — The information and data provided in a Product data sheet shall define the specification of the product as agreed between Nexperia and its customer, unless Nexperia and customer have explicitly agreed otherwise in writing. In no event however, shall an agreement be valid in which the Nexperia product is deemed to offer functions and qualities beyond those described in the Product data sheet.

15.3 Disclaimers

Limited warranty and liability — Information in this document is believed to be accurate and reliable. However, Nexperia does not give any representations or warranties, expressed or implied, as to the accuracy or completeness of such information and shall have no liability for the consequences of use of such information. Nexperia takes no responsibility for the content in this document if provided by an information source outside of Nexperia.

In no event shall Nexperia be liable for any indirect, incidental, punitive, special or consequential damages (including - without limitation - lost profits, lost savings, business interruption, costs related to the removal or replacement of any products or rework charges) whether or not such damages are based on tort (including negligence), warranty, breach of contract or any other legal theory.

Notwithstanding any damages that customer might incur for any reason whatsoever, Nexperia's aggregate and cumulative liability towards customer for the products described herein shall be limited in accordance with the *Terms and conditions of commercial sale* of Nexperia.

Right to make changes — Nexperia reserves the right to make changes to information published in this document, including without limitation specifications and product descriptions, at any time and without notice. This document supersedes and replaces all information supplied prior to the publication hereof.

Suitability for use in automotive applications — This Nexperia product has been qualified for use in automotive applications. Unless otherwise agreed in writing, the product is not designed, authorized or warranted to be suitable for use in life support, life-critical or safety-critical systems or equipment, nor in applications where failure or malfunction of a Nexperia product can reasonably be expected to result in personal injury, death or severe property or environmental damage. Nexperia and its suppliers accept no liability for inclusion and/or use of Nexperia products in such equipment or applications and therefore such inclusion and/or use is at the customer's own risk.

Applications — Applications that are described herein for any of these products are for illustrative purposes only. Nexperia makes no representation or warranty that such applications will be suitable for the specified use without further testing or modification.

Customers are responsible for the design and operation of their applications and products using Nexperia products, and Nexperia accepts no liability for any assistance with applications or customer product design. It is customer's sole responsibility to determine whether the Nexperia product is suitable and fit for the customer's applications and products planned, as well as for the planned application and use of customer's third party customer(s). Customers should provide appropriate design and operating safeguards to minimize the risks associated with their applications and products.

Nexperia does not accept any liability related to any default, damage, costs or problem which is based on any weakness or default in the customer's applications or products, or the application or use by customer's third party customer(s). Customer is responsible for doing all necessary testing for the customer's applications and products using Nexperia products in order to avoid a default of the applications and the products or of the application or use by customer's third party customer(s). Nexperia does not accept any liability in this respect.

Limiting values — Stress above one or more limiting values (as defined in the Absolute Maximum Ratings System of IEC 60134) will cause permanent damage to the device. Limiting values are stress ratings only and (proper) operation of the device at these or any other conditions above those given in the Recommended operating conditions section (if present) or the Characteristics sections of this document is not warranted. Constant or repeated exposure to limiting values will permanently and irreversibly affect the quality and reliability of the device.

Terms and conditions of commercial sale — Nexperia products are sold subject to the general terms and conditions of commercial sale, as published at <http://www.nexperia.com/profile/terms>, unless otherwise agreed in a valid written individual agreement. In case an individual agreement is concluded only the terms and conditions of the respective agreement shall apply. Nexperia hereby expressly objects to applying the customer's general terms and conditions with regard to the purchase of Nexperia products by customer.

No offer to sell or license — Nothing in this document may be interpreted or construed as an offer to sell products that is open for acceptance or the grant, conveyance or implication of any license under any copyrights, patents or other industrial or intellectual property rights.

Export control — This document as well as the item(s) described herein may be subject to export control regulations. Export might require a prior authorization from competent authorities.

Translations — A non-English (translated) version of a document is for reference only. The English version shall prevail in case of any discrepancy between the translated and English versions.

15.4 Trademarks

Notice: All referenced brands, product names, service names and trademarks are the property of their respective owners.

16. Contact information

For more information, please visit: <http://www.nexperia.com>

For sales office addresses, please send an email to: salesaddresses@nexperia.com

17. Contents

| | | |
|-----------|---|-----------|
| 1 | General description | 1 |
| 2 | Features and benefits | 1 |
| 3 | Ordering information | 2 |
| 4 | Functional diagram | 2 |
| 5 | Pinning information | 3 |
| 5.1 | Pinning | 3 |
| 5.2 | Pin description | 3 |
| 6 | Functional description | 4 |
| 7 | Limiting values | 4 |
| 8 | Recommended operating conditions | 5 |
| 9 | Static characteristics | 5 |
| 10 | Dynamic characteristics | 6 |
| 11 | AC waveforms | 7 |
| 12 | Package outline | 10 |
| 13 | Abbreviations | 13 |
| 14 | Revision history | 13 |
| 15 | Legal information | 14 |
| 15.1 | Data sheet status | 14 |
| 15.2 | Definitions | 14 |
| 15.3 | Disclaimers | 14 |
| 15.4 | Trademarks | 15 |
| 16 | Contact information | 15 |
| 17 | Contents | 16 |

Mouser Electronics

Authorized Distributor

Click to View Pricing, Inventory, Delivery & Lifecycle Information:

[Nexperia:](#)

[74LVC541APW-Q100J](#) [74LVC541ABQ-Q100X](#) [74LVC541AD-Q100J](#)