

## MMBT3906 TRANSISTOR (PNP)

### FEATURES

- Complementary Type The NPN Transistor
- MMBT3904 is Recommended
- Epitaxial Planar Die Construction

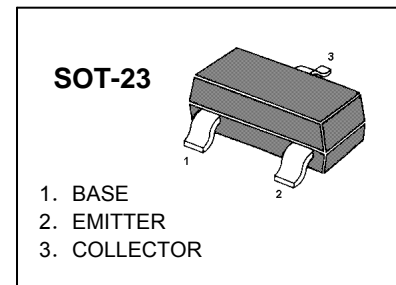

**MARKING: 2A**

### MAXIMUM RATINGS ( $T_a=25^\circ\text{C}$ unless otherwise noted)

Symbol	Parameter	Value	Unit
$V_{CBO}$	Collector-Base Voltage	-40	V
$V_{CEO}$	Collector-Emitter Voltage	-40	V
$V_{EBO}$	Emitter-Base Voltage	-5	V
$I_C$	Collector Current	-200	mA
$P_C$	Total Device Dissipation	200	mW
$R_{\theta JA}$	Thermal Resistance Junction to Ambient	625	$^\circ\text{C}/\text{W}$
$T_J$	Junction Temperature	150	$^\circ\text{C}$
$T_{stg}$	Storage Temperature	-55 ~ +150	$^\circ\text{C}$

### ELECTRICAL CHARACTERISTICS ( $T_a=25^\circ\text{C}$ unless otherwise specified)

Parameter	Symbol	Test conditions	Min	Max	Unit
Collector-base breakdown voltage	$V_{(BR)CBO}$	$I_C=-10\mu\text{A}, I_E=0$	-40		V
Collector-emitter breakdown voltage	$V_{(BR)CEO}$	$I_C=-1\text{mA}, I_B=0$	-40		V
Emitter-base breakdown voltage	$V_{(BR)EBO}$	$I_E=-10\mu\text{A}, I_C=0$	-5		V
Collector cut-off current	$I_{CBO}$	$V_{CB}=-40\text{V}, I_E=0$		-0.1	$\mu\text{A}$
Collector cut-off current	$I_{CEX}$	$V_{CE}=-30\text{V}, V_{BE(off)}=-3\text{V}$		-50	nA
Emitter cut-off current	$I_{EBO}$	$V_{EB}=-5\text{V}, I_C=0$		-0.1	$\mu\text{A}$
DC current gain	$h_{FE(1)}$	$V_{CE}=-1\text{V}, I_C=-10\text{mA}$	100	300	
	$h_{FE(2)}$	$V_{CE}=-1\text{V}, I_C=-50\text{mA}$	60		
	$h_{FE(3)}$	$V_{CE}=-1\text{V}, I_C=-100\text{mA}$	30		
Collector-emitter saturation voltage	$V_{CE(sat)}$	$I_C=-50\text{mA}, I_B=-5\text{mA}$		-0.3	V
Base-emitter saturation voltage	$V_{BE(sat)}$	$I_C=-50\text{mA}, I_B=-5\text{mA}$		-0.95	V
Transition frequency	$f_T$	$V_{CE}=-20\text{V}, I_C=-10\text{mA}, f=100\text{MHz}$	300		MHz
Delay Time	$t_d$	$V_{CC}=-3\text{V}, V_{BE}=-0.5\text{V}$		35	nS
Rise Time	$t_r$	$I_C=-10\text{mA}, I_{B1}=-I_{B2}=-1\text{mA}$		35	nS
Storage Time	$t_s$	$V_{CC}=-3\text{V}, I_C=-10\text{mA},$		225	nS
Fall Time	$t_f$	$I_{B1}=-I_{B2}=-1\text{mA}$		75	nS

## Typical Characteristics

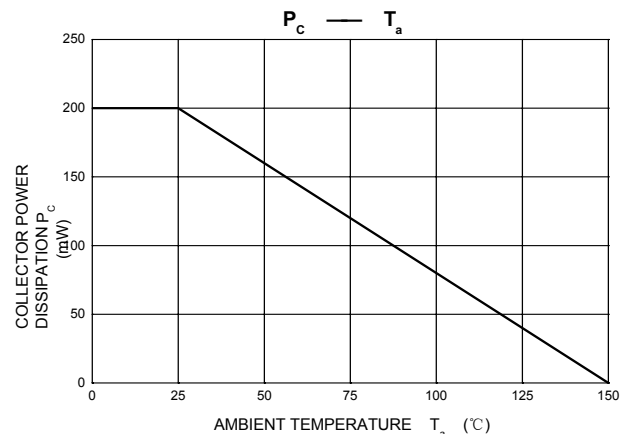
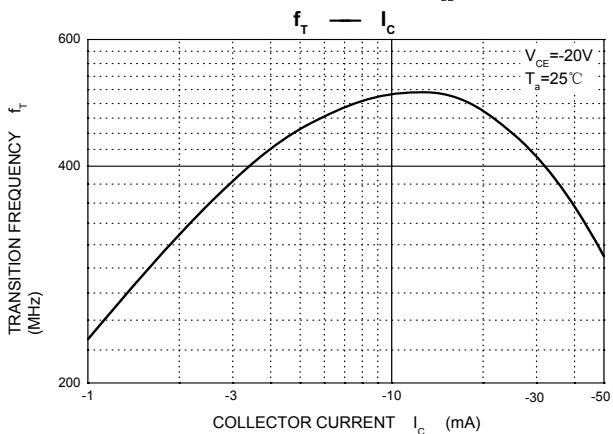
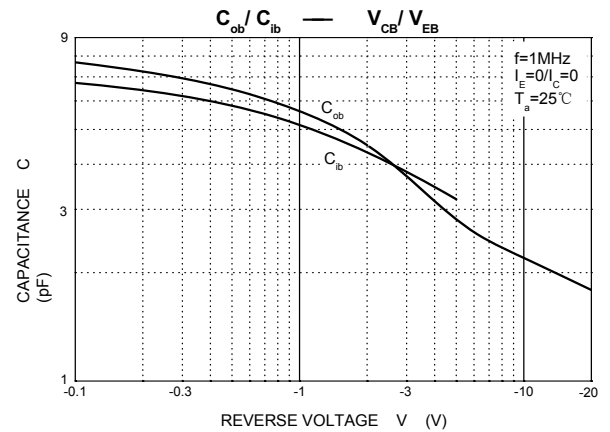
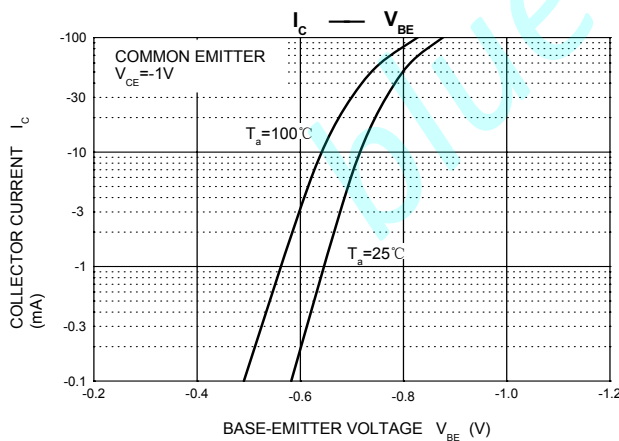
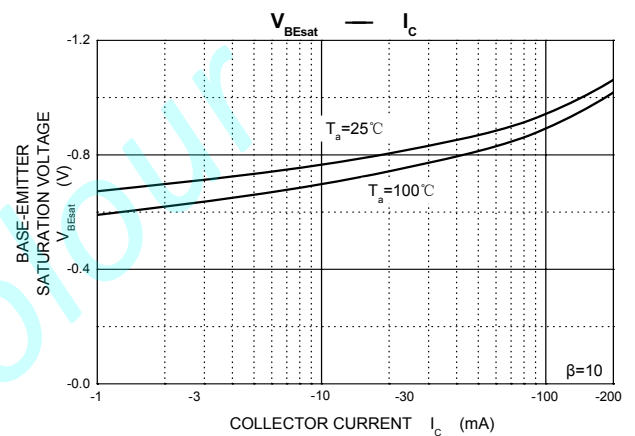
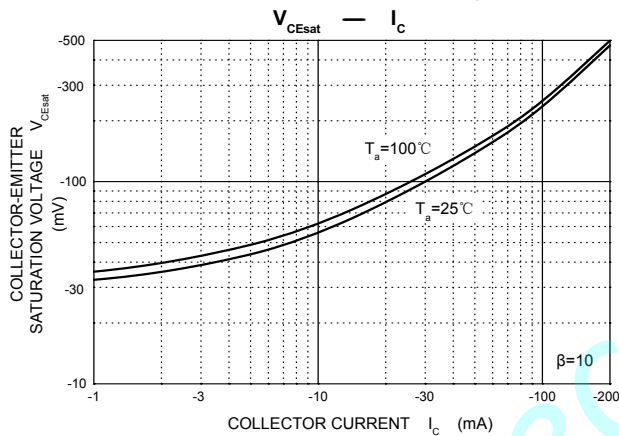
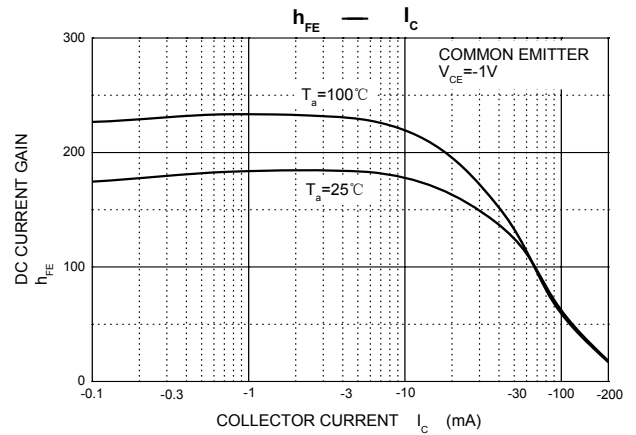
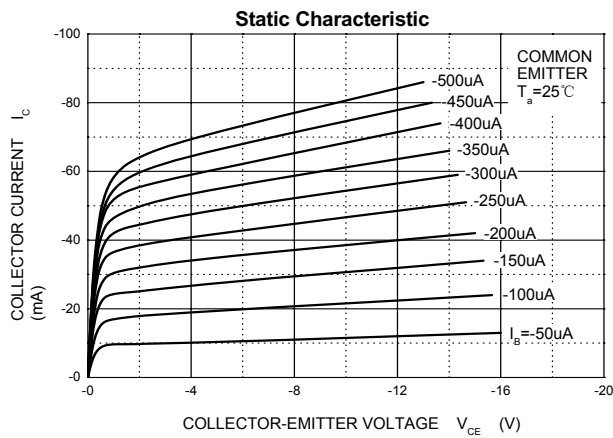

## PACKAGE OUTLINE

Plastic surface mounted package; 3 leads

SOT-23

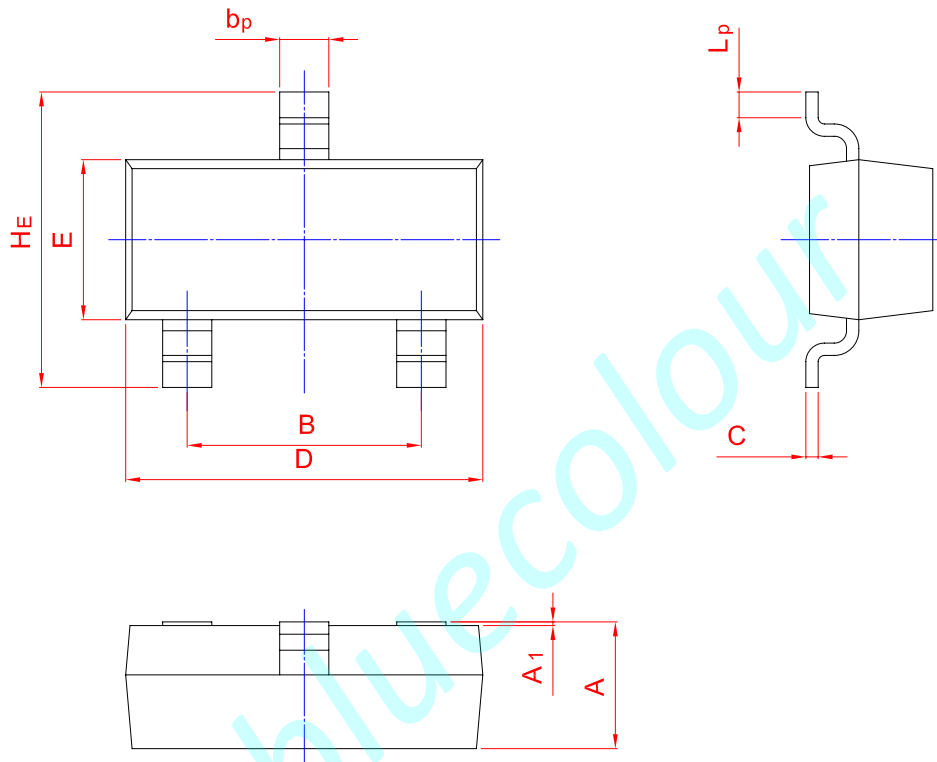
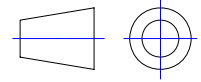

UNIT	A	B	bp	C	D	E	HE	A1	Lp
mm	1.40	2.04	0.50	0.19	3.10	1.65	3.00	0.100	0.50
	0.95	1.78	0.35	0.08	2.70	1.20	2.20	0.013	0.20