

Specifications

Current rating:3A AC,DC
Voltage rating:250V AC,DC
Temperature range:-40°C~+105°C
Contact resistance:10mΩ Max.
Insulation resistance:500MΩ Min.
Withstanding voltage:5000V AC/minute
Compliant with RoHS and REACH
Meet the HF/Halogen Free,need to customize
Contact CJT for details

Standards



Assembly layout

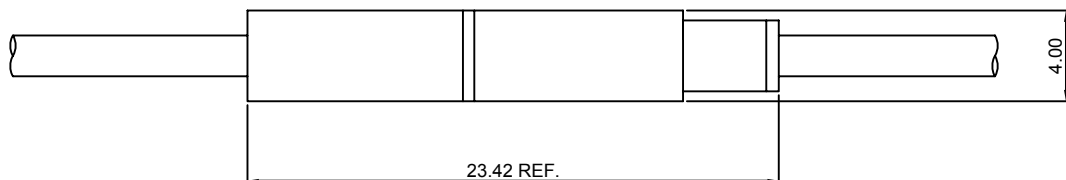

C2501F-T

2.50mm pitch Crimp Terminal

Reference Informations:

*Used in CJT C2501HF-2P series Housing

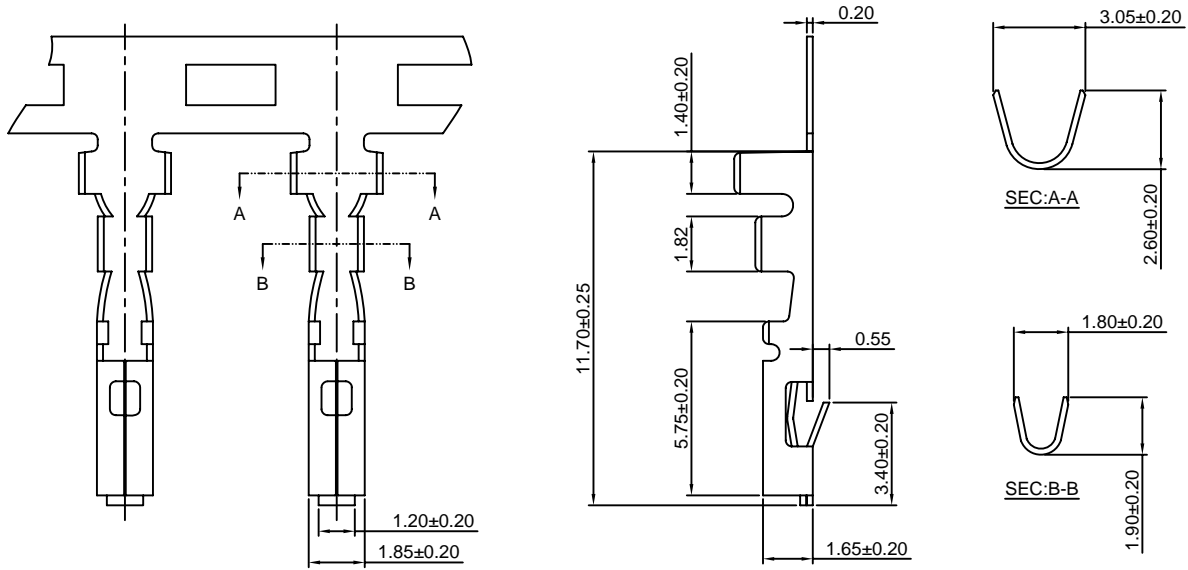

Ordering information & Specifications:

Unit:mm

Part NO.	Wire Range	Insulation O.D.	Material	Finish	Qty/reel
C2501F-TB	AWG#22-#28	1.80mm(max)	Brass	Tin over Nickel	7,000 PCS
C2501F-TP	AWG#22-#28	1.80mm(max)	Phosphor Bronze	Tin over Nickel	7,000 PCS
C2501F-GB	AWG#22-#28	1.80mm(max)	Brass	Gold over Nickel	7,000 PCS
C2501F-GP	AWG#22-#28	1.80mm(max)	Phosphor Bronze	Gold over Nickel	7,000 PCS

Optional Gold plating available but MOQ requested

C2501HF-2P

2.50mm Pitch Housing

Reference Informations:

- *Material:Nylon 66,UL94V-2 or UL94V-0
- *Suitable CJT C2501F-T series Terminal
- *Mates with CJT C2501HM-2P series Housing
- *Color:Red

Ordering Information:

- C2501HF-2P - ***
- | | |
|---|---|
| 1 | 2 |
|---|---|
- 1.Part No.
 - 2.Color and Material:
 (blank):Red/Nylon 66,UL94V-2
 WH:White/Nylon 66,UL94V-0
 BK:Black/Nylon 66,UL94V-0
 GWT:Nylon 66,UL94V-0,GWT 750°C

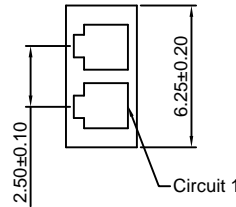
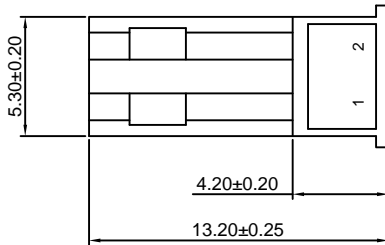
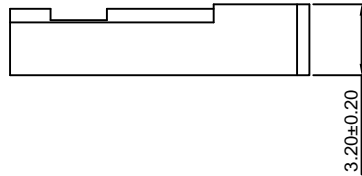
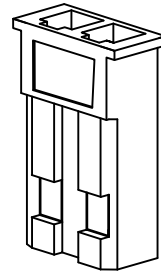

Unit: mm

C2501HM-2P

2.50mm Pitch Housing

Reference Informations:

- *Material:Nylon 66,UL94V-2 or UL94V-0
- *Suitable CJT C2521M-T series Terminal
- *Mates with CJT C2501HF-2P series Housing
- *Color:Red

Ordering Information:

- C2501HM-2P - ***
- | | |
|---|---|
| 1 | 2 |
|---|---|
- 1.Part No.
 - 2.Color and Material:
 (blank):Red/Nylon 66,UL94V-2
 WH:White/Nylon 66,UL94V-0
 BK:Black/Nylon 66,UL94V-0
 GWT:Nylon 66,UL94V-0,GWT 750°C

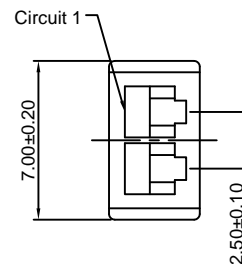
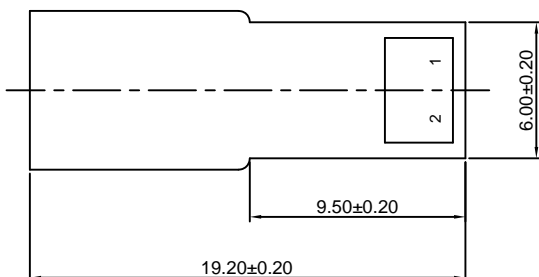
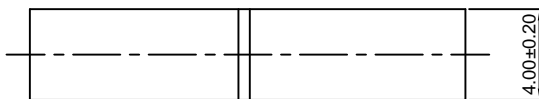
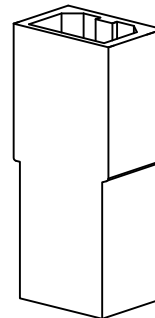

Unit: mm