

MMBT5551 TRANSISTOR (NPN)

FEATURES

Complementary to MMBT5401

Ideal for medium power amplification and switching

MARKING: G1

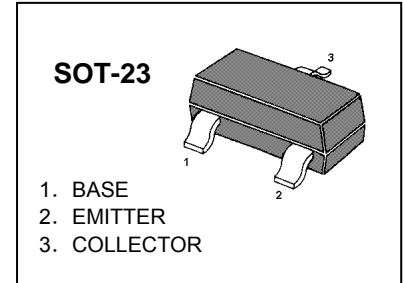

MAXIMUM RATINGS ($T_A=25^{\circ}\text{C}$ unless otherwise noted)

Symbol	Parameter	Value	Units
V_{CBO}	Collector-Base Voltage	180	V
V_{CEO}	Collector-Emitter Voltage	160	V
V_{EBO}	Emitter-Base Voltage	6	V
I_C	Collector Current -Continuous	0.6	A
P_C	Collector Power Dissipation	300	mW
T_j	Junction Temperature	150	$^{\circ}\text{C}$
T_{stg}	Storage Temperature	-55-150	$^{\circ}\text{C}$

ELECTRICAL CHARACTERISTICS ($T_{amb}=25^{\circ}\text{C}$ unless otherwise specified)

Parameter	Symbol	Test conditions	MIN	TYP	MAX	UNIT
Collector-base breakdown voltage	$V_{(BR)CBO}$	$I_C=100\mu\text{A}$, $I_E=0$	180			V
Collector-emitter breakdown voltage	$V_{(BR)CEO}^*$	$I_C=1\text{mA}$, $I_B=0$	160			V
Emitter-base breakdown voltage	$V_{(BR)EBO}$	$I_E=10\mu\text{A}$, $I_C=0$	6			V
Collector cut-off current	I_{CBO}	$V_{CB}=120\text{V}$, $I_E=0$			50	nA
Emitter cut-off current	I_{EBO}	$V_{EB}=4\text{V}$, $I_C=0$			50	nA
DC current gain	h_{FE1}^*	$V_{CE}=5\text{V}$, $I_C=1\text{mA}$	80			
	h_{FE2}^*	$V_{CE}=5\text{V}$, $I_C=10\text{mA}$	100		300	
	h_{FE3}^*	$V_{CE}=5\text{V}$, $I_C=50\text{mA}$	50			
Collector-emitter saturation voltage	V_{CEsat}^*	$I_C=10\text{mA}$, $I_B=1\text{mA}$			0.15	V
		$I_C=50\text{mA}$, $I_B=5\text{mA}$			0.2	
Base-emitter saturation voltage	V_{BEsat}^*	$I_C=10\text{mA}$, $I_B=1\text{mA}$			1	V
		$I_C=50\text{mA}$, $I_B=5\text{mA}$			1	
Transition frequency	f_T	$V_{CE}=10\text{V}$, $I_C=10\text{mA}$, $f=100\text{MHz}$	100		300	MHz
Collector output capacitance	C_{ob}	$V_{CB}=10\text{V}$, $I_E=0$, $f=1\text{MHz}$			6	pF
Input capacitance	C_{ib}	$V_{BE}=0.5\text{V}$, $I_C=0$, $f=1\text{MHz}$			20	pF
Noise figure	NF	$V_{CE}=5\text{V}$, $I_C=0.25\text{mA}$, $f=10\text{Hz}$ to 15.7KHz , $R_s=1\text{k}\Omega$			8	dB

Typical Characteristics

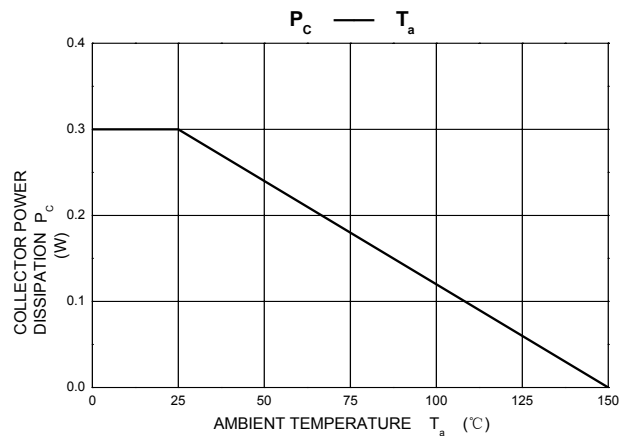
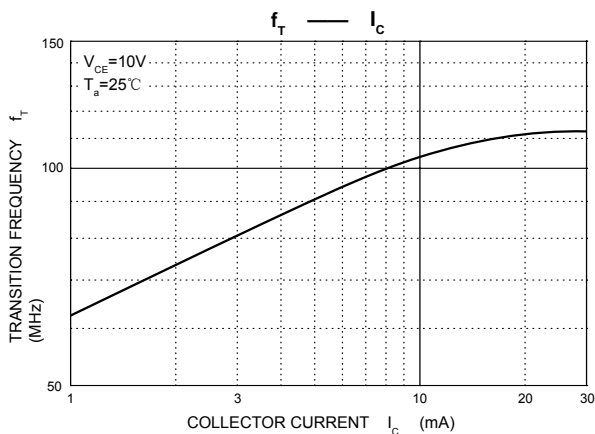
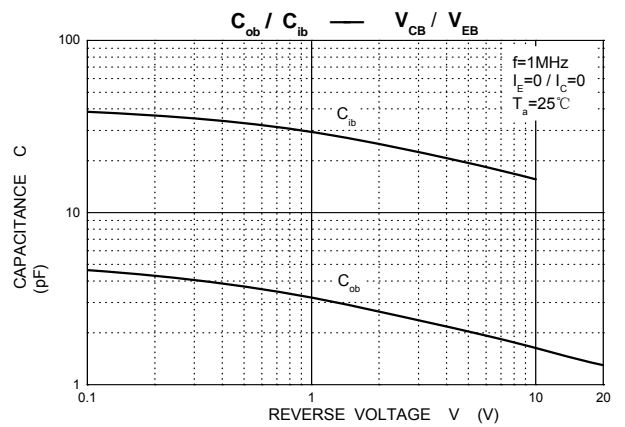
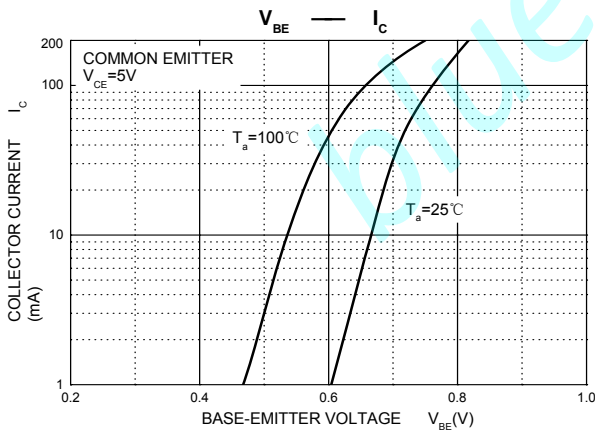
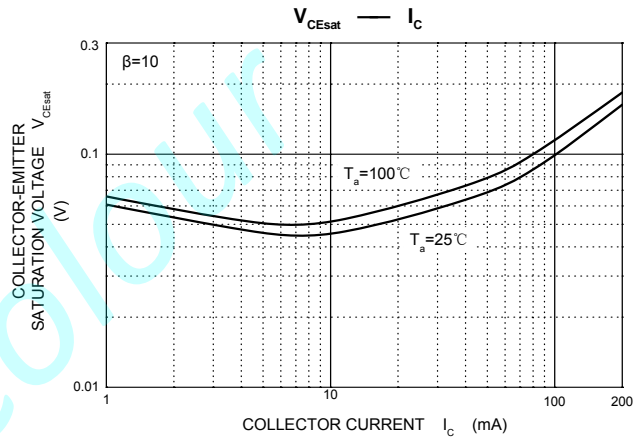
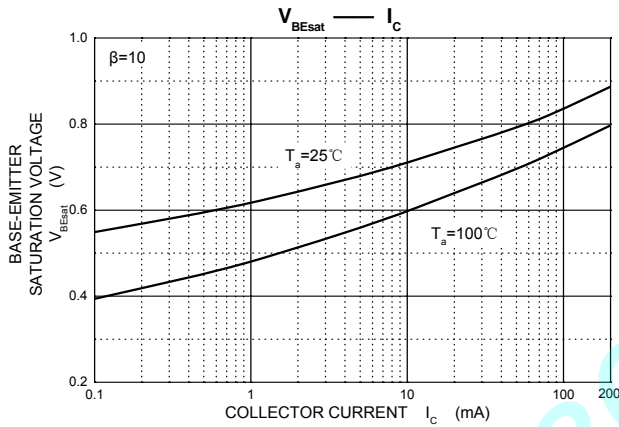
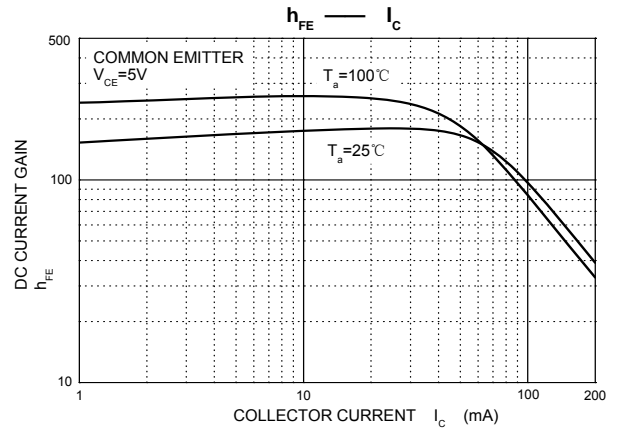
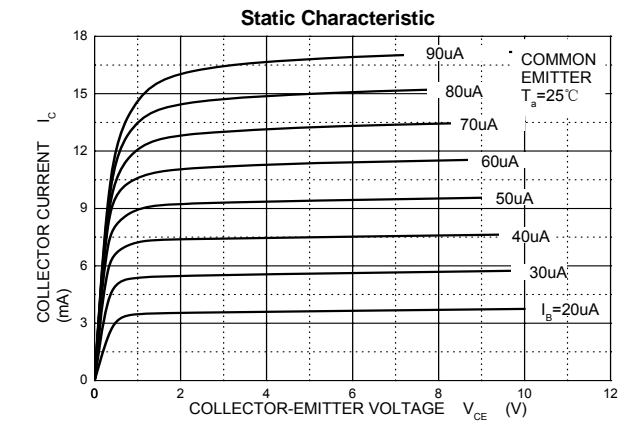

PACKAGE OUTLINE

Plastic surface mounted package; 3 leads

SOT-23

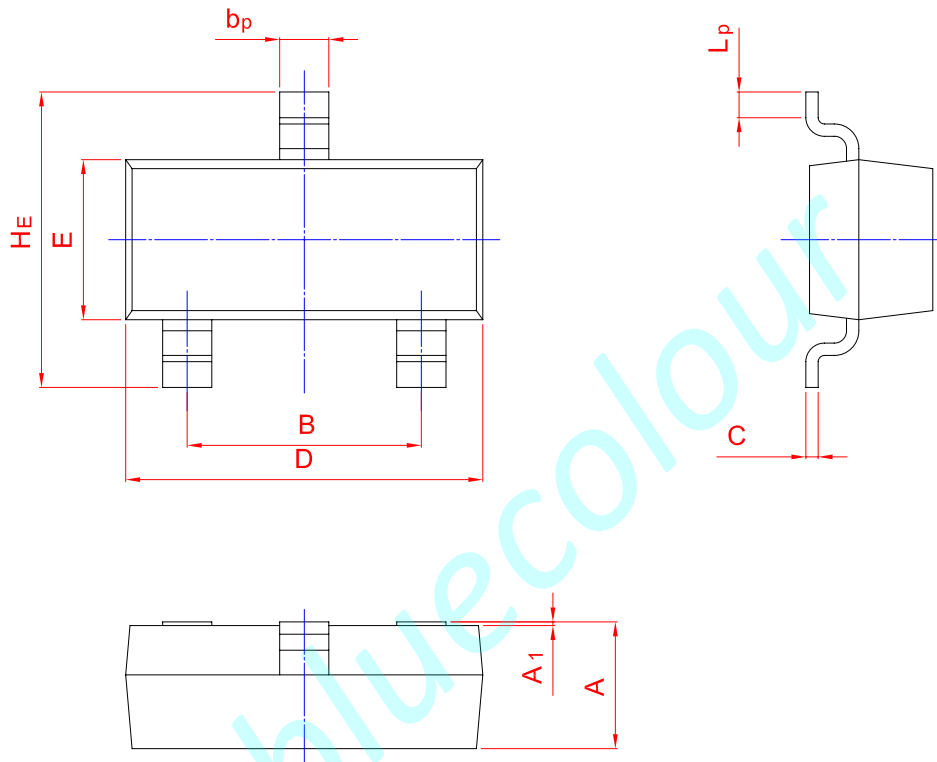
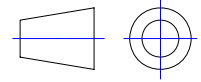

UNIT	A	B	bp	C	D	E	HE	A1	Lp
mm	1.40	2.04	0.50	0.19	3.10	1.65	3.00	0.100	0.50
	0.95	1.78	0.35	0.08	2.70	1.20	2.20	0.013	0.20