

Specifications

Current rating:2A AC,DC
Voltage rating:100V AC,DC
Temperature range:-40°C~+105°C
Contact resistance:10mΩMax.
Insulation resistance:1000MΩMin.
Withstanding voltage:800V AC/minute
Compliant with RoHS and REACH
Meet the HF/Halogen Free,need to customize
Contact CJT for details

Standards



Assembly layout

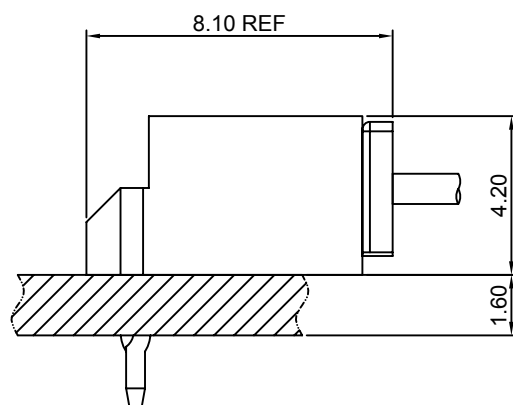
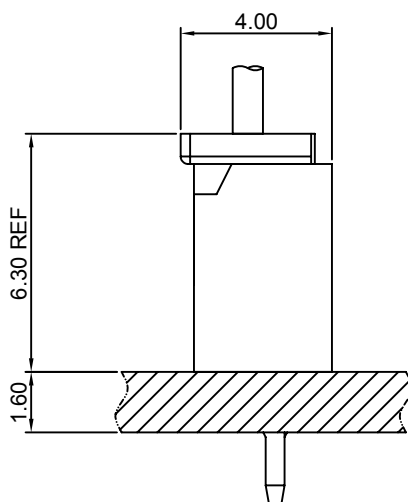

A2010-T

2.00mm Pitch Crimp Terminal

Reference Informations:

*Used in CJT A2010H, HA-XP, A2010HA-2xXP, A2008HA-XP series Housing

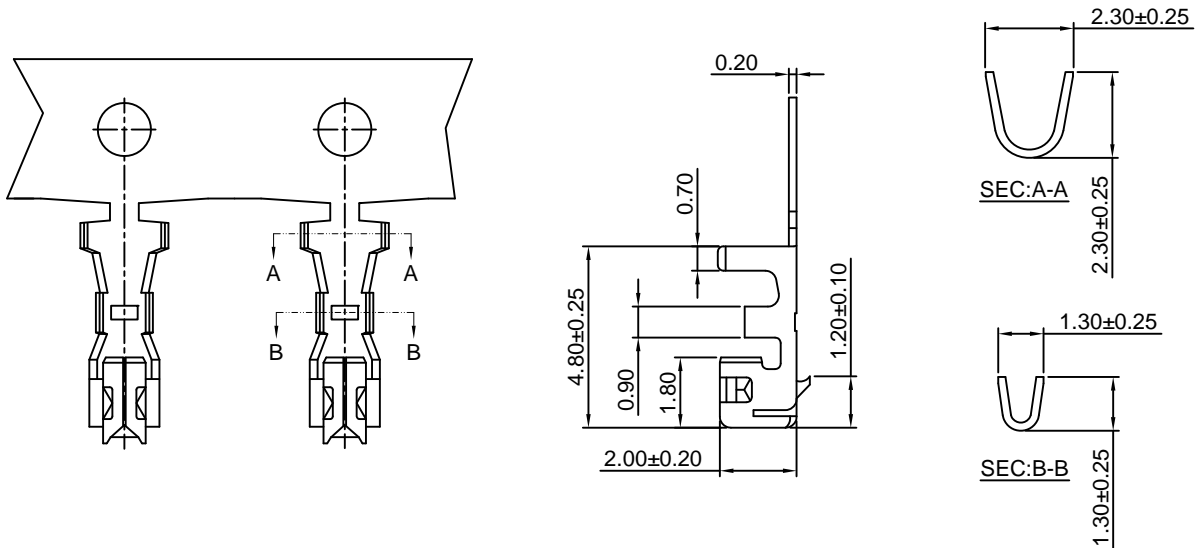

Ordering information & Specifications:

Unit:mm

Part NO.	Wire Range	Insulation O.D.	Material	Finish	Qty/reel
A2010-TP	AWG#24-#30	1.40mm(max)	Phosphor Bronze	Tin over Nickel	10,000 PCS
A2010-GP	AWG#24-#30	1.40mm(max)	Phosphor Bronze	Gold over Nickel	10,000 PCS

Optional Gold plating available but MOQ requested

A2010H-XP

2.00mm Pitch Housing

Reference Informations:

*Material:PBT+15%GF,UL94V-0

*Suitable CJT A2010-T series Terminal

*Mates with CJT A2010WV,WR-XP,A2010WV-F-XP series Wafer

*Color:White

Ordering Information:

A2010H-XP - *** - **
1 2 3

1. Part No.

2. Material:

(Blank):PBT+15%GF,UL94V-0

GWT:PBT,UL94V-0,GWT 750 °C

3. Color:

(Blank):White

BK:Black

RD:Red

YL:Yellow

BL:Blue

GN:Green

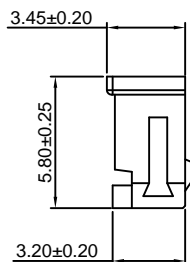
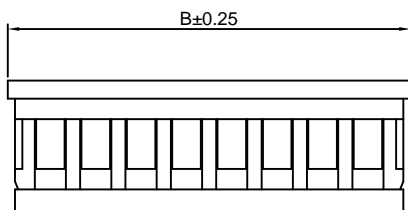
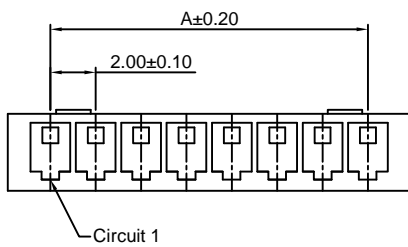
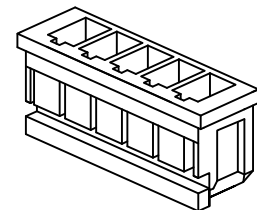

Ordering Information & Dimensions:

PART NO.	Dimensions	
	A	B
2P	2.00	5.80
3P	4.00	7.80
4P	6.00	9.80
5P	8.00	11.80
6P	10.00	13.80
7P	12.00	15.80
8P	14.00	17.80
9P	16.00	19.80
10P	18.00	21.80
11P	20.00	23.80
12P	22.00	25.80
13P	24.00	27.80
14P	26.00	29.80
15P	28.00	31.80

Unit: mm

A2010HA-XP

2.00mm Pitch Housing

Reference Informations:

- *Material: PBT+15%GF, UL94V-0
- *Suitable CJT A2010-T series Terminal
- *Color: White

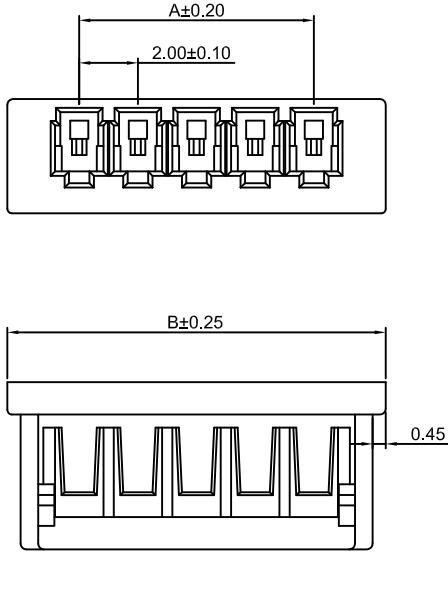

Ordering Information:

A2010HA-XP - ***
1 2

1. Part No.

2. Material:

(Blank): PBT+15%GF, UL94V-0

GWT: PBT, UL94V-0, GWT 750 °C

Ordering Information & Dimensions:

PART NO.	Dimensions	
	A	B
2P	2.00	6.90
3P	4.00	8.90
4P	6.00	10.90
5P	8.00	12.90
6P	10.00	14.90
7P	12.00	16.90
8P	14.00	18.90
9P	16.00	20.90
10P	18.00	22.90
11P	20.00	24.90
12P	22.00	26.90
13P	24.00	28.90
14P	26.00	30.90
15P	28.00	32.90

Unit: mm

A2010HC-XP

2.00mm Pitch Housing

Reference Informations:

- *Material: PBT, UL94V-0
- *Suitable CJT A2010-T series Terminal
- *Mates with CJT A2010WVC, WRC-XP, series Wafer
- *Color: White

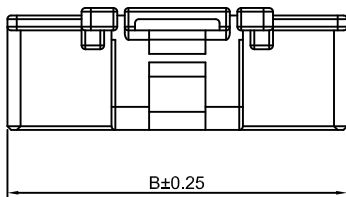

Ordering Information:

A2010HC-XP - ***
1 2

1. Part No.

2. Color:

(blank) - Natural

BK - Black

RD - Red

BL - Blue

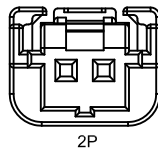
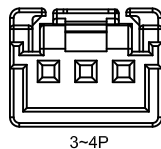
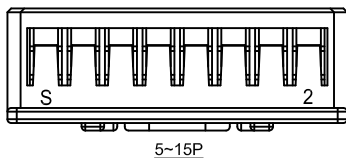
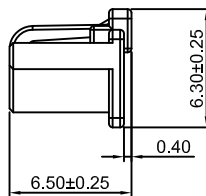
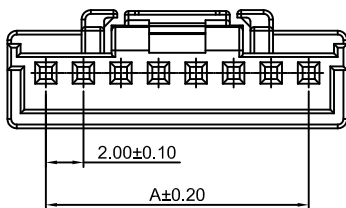
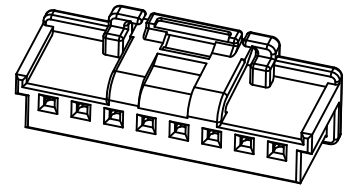

Ordering Information & Dimensions:

PART NO.	Dimensions	
	A	B
2P	2.00	8.00
3P	4.00	8.10
4P	6.00	10.10
5P	8.00	12.10
6P	10.00	14.10
7P	12.00	16.10
8P	14.00	18.10
9P	16.00	20.10
10P	18.00	22.10
11P	20.00	24.10
12P	22.00	26.10
13P	24.00	28.10
14P	26.00	30.10
15P	28.00	32.10

Unit: mm

A2010HA-2xXP

2.00mm Pitch Dual Row Housing

Reference Informations:

- *Material: Nylon 66, UL94V-0
- *Suitable CJT A2010-T series Terminal
- *Mates with CJT A2010WVA-F-2xXP, A2012WVB-F-2xXP series Dual Row Wafer
- *Color: Gray



Ordering Information:

- A2010HA-2xXP - ***
 1
 2
1. Part No.
 2. Material:
 (Blank): Nylon 66, UL94V-0
 GWT: Nylon 66, UL94V-0, GWT 750 °C

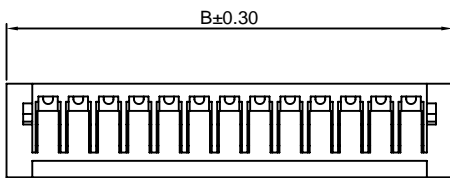
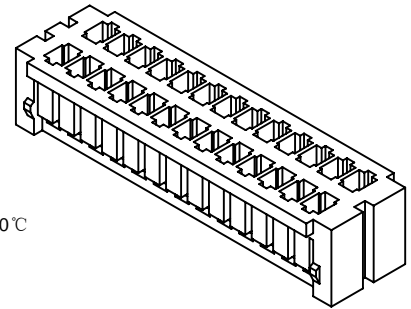

2x5P~2x14P

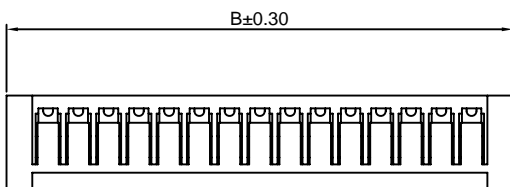
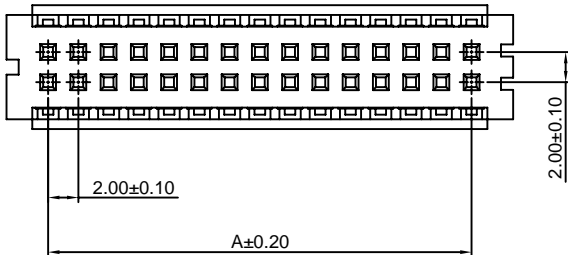
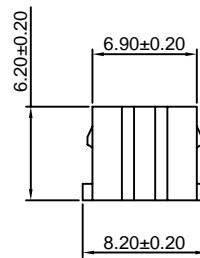

2x15P~2x30P

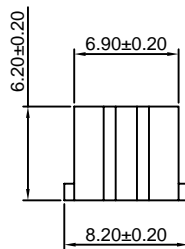

Ordering Information & Dimensions:

PART NO.	Dimensions	
	A	B
2x5P	8.00	13.50
2x6P	10.00	15.50
2x7P	12.00	17.50
2x8P	14.00	19.50
2x9P	16.00	21.50
2x10P	18.00	23.50
2x11P	20.00	25.50
2x12P	22.00	27.50
2x13P	24.00	29.50
2x14P	26.00	31.50
2x15P	28.00	33.50
2x16P	30.00	35.50
2x17P	32.00	37.50
2x20P	38.00	43.50
2x25P	48.00	53.50
2x30P	58.00	63.50

Unit: mm

A2010WV-XP

2.00mm Pitch 180° Wafer

Reference Informations:

- *Material:Pin:Brass/Tin over Nickel
Insulator:Nylon 66+30%GF,UL94V-0
- *Mates with CJT A2010H-XP series Housing
- *Color:White

Ordering Information:

A2010WV-XP - *** - **
1 2 3

- 1.Part No.
- 2.Material:
(Blank):Nylon 66+30%GF,UL94V-0
GWT:Nylon 66,UL94V-0,GWT 750 °C
- 3.Color:
(Blank):White
BK:Black
RD:Red
YL:Yellow
BL:Blue
GN:Green

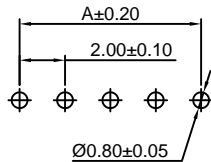
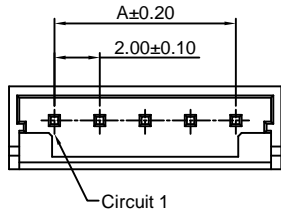
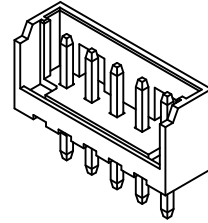

P.C.B LAYOUT

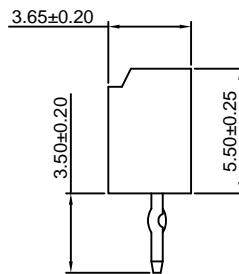
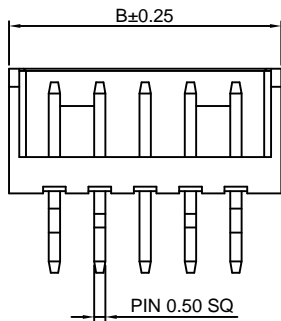

Ordering Information & Dimensions:

PART NO.	Dimensions	
	A	B
2P	2.00	6.00
3P	4.00	8.00
4P	6.00	10.00
5P	8.00	12.00
6P	10.00	14.00
7P	12.00	16.00
8P	14.00	18.00
9P	16.00	20.00
10P	18.00	22.00
11P	20.00	24.00
12P	22.00	26.00
13P	24.00	28.00
14P	26.00	30.00
15P	28.00	32.00

Unit: mm

A2010WR-XP

2.00mm Pitch 90° Wafer

Reference Informations:

- *Material:Pin:Brass/Tin over Nickel
Insulator:Nylon 66+30%GF,UL94V-0
- *Mates with CJT A2010H-XP series Housing
- *Color:White

Ordering Information:

A2010WR-XP - *** - **
1 2 3

- 1.Part No.
- 2.Material:
(Blank):Nylon 66+30%GF,UL94V-0
GWT:Nylon 66,UL94V-0,GWT 750 °C
- 3.Color:
(Blank):White
BK:Black
RD:Red
YL:Yellow
BL:Blue
GN:Green

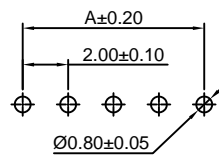
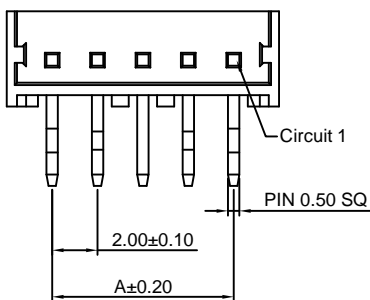
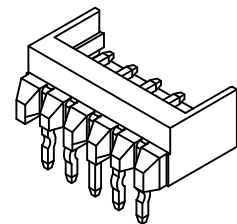

P.C.B LAYOUT

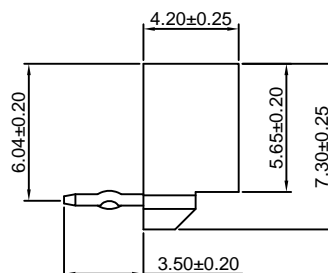
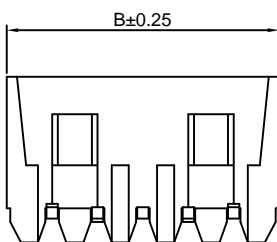

Ordering Information & Dimensions:

PART NO.	Dimensions	
	A	B
2P	2.00	6.00
3P	4.00	8.00
4P	6.00	10.00
5P	8.00	12.00
6P	10.00	14.00
7P	12.00	16.00
8P	14.00	18.00
9P	16.00	20.00
10P	18.00	22.00
11P	20.00	24.00
12P	22.00	26.00
13P	24.00	28.00
14P	26.00	30.00
15P	28.00	32.00

Unit: mm

A2010WV-F-XP

2.00mm Pitch 180° Wafer

Reference Informations:

- *Material:Pin:Brass/Tin over Nickel
Insulator:Nylon 66+30%GF,UL94V-0
- *Mates with CJT A2010H-XP series Housing
- *Color:White

Ordering Information:

A2010WV-F-XP - *** - **
1 2 3

- Part No.
- Material:
(Blank):Nylon 66+30%GF,UL94V-0
GWT:Nylon 66,UL94V-0,GWT 750 °C
- Color:
(Blank):White
BK:Black
RD:Red
YL:Yellow
BL:Blue
GN:Green

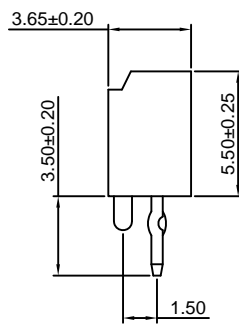
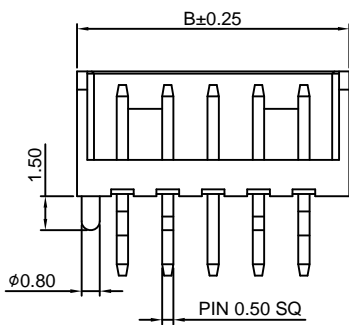
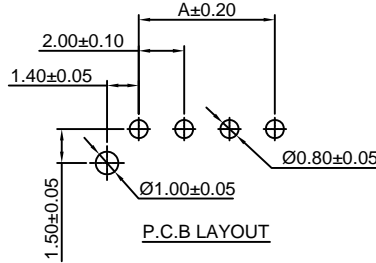
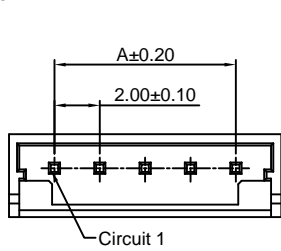

Ordering Information & Dimensions:

PART NO.	Dimensions	
	A	B
2P	2.00	6.00
3P	4.00	8.00
4P	6.00	10.00
5P	8.00	12.00
6P	10.00	14.00
7P	12.00	16.00
8P	14.00	18.00
9P	16.00	20.00
10P	18.00	22.00
11P	20.00	24.00
12P	22.00	26.00
13P	24.00	28.00
14P	26.00	30.00
15P	28.00	32.00

Unit: mm

A2010WVA-F-2xXP

2.00mm Pitch 180° Dual Row Wafer

Reference Informations:

- *Material:Pin:Brass/Tin over Nickel
Insulator:Nylon 66,UL94V-0
- *Mates with CJT A2010HA-2xXP series Dual Row Housing
- *Color:Gray

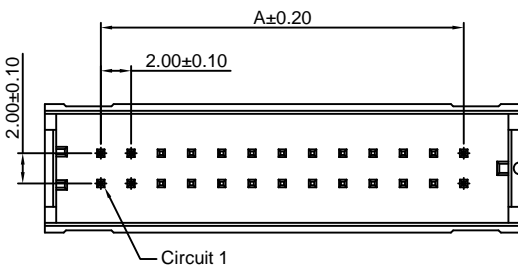
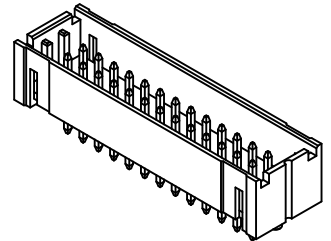
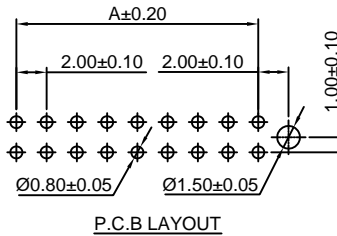

Ordering Information:

A2010WVA-F-2xXP - ***
1 2

- Part No.
- Material:
(Blank):Nylon 66,UL94V-0
GWT:Nylon 66,UL94V-0,GWT 750 °C

Ordering Information & Dimensions:

PART NO.	Dimensions	
	A	B
2x2P	2.00	9.40
2x3P	4.00	11.40
2x4P	6.00	13.40
2x5P	8.00	15.40
2x6P	10.00	17.40
2x7P	12.00	19.40
2x8P	14.00	21.40
2x9P	16.00	23.40
2x10P	18.00	25.40
2x11P	20.00	27.40
2x12P	22.00	29.40
2x13P	24.00	31.40
2x14P	26.00	33.40
2x15P	28.00	35.40
2x16P	30.00	37.40
2x17P	32.00	39.40
2x20P	38.00	45.40
2x25P	48.00	55.40
2x30P	58.00	65.40

Unit: mm

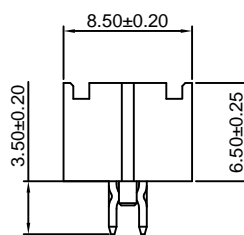
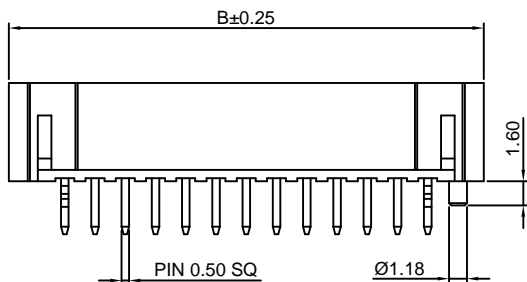

A2010WVB-F-2xXP

2.00mm Pitch 180° Dual Row Wafer

Reference Informations:

- *Material:Pin:Brass/Tin over Nickel
Insulator:Nylon 66,UL94V-0
- *Mates with CJT A2010HA-2xXP series Dual Row Housing
- *Color:Gray

Ordering Information:

- A2010WVB-F-2xXP - ***
1 2
- 1.Part No.
 - 2.Material:
(Blank):Nylon 66,UL94V-0
GWT:Nylon 66,UL94V-0,GWT 750 °C

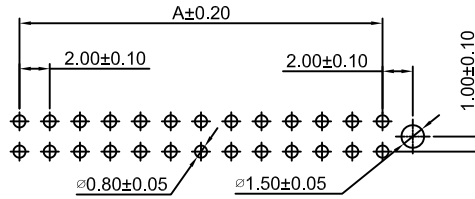
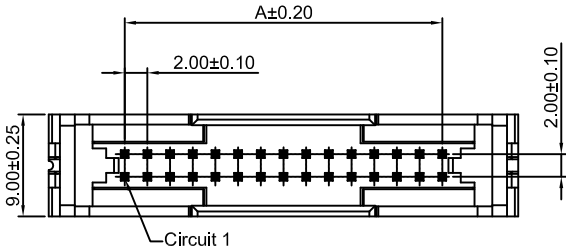
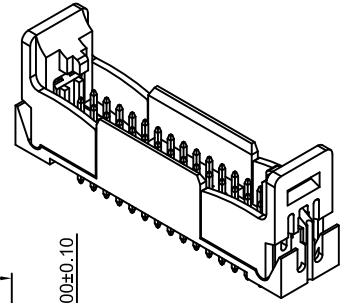

P.C.B LAYOUT

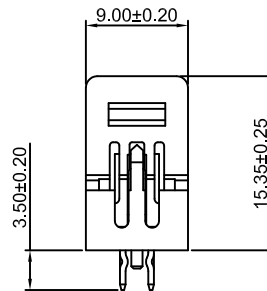
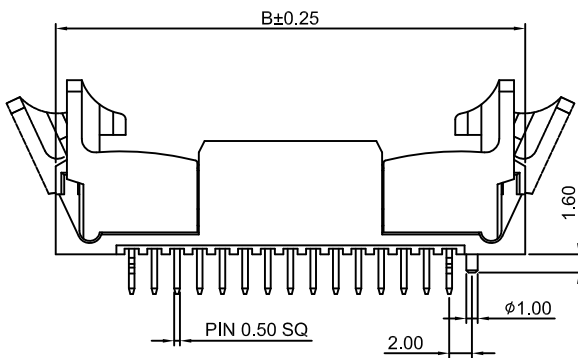

Ordering Information & Dimensions:

PART NO.	Dimensions	
	A	B
2x15P	28.00	41.40
2x17P	32.00	45.40
2x20P	38.00	51.40
2x25P	48.00	61.40
2x30P	58.00	71.40

Unit: mm

A2010WVC-S-XP

2.00mm Pitch 180° Wafer

Reference Informations:

- *Material:Pin:Brass/Tin over Nickel
Insulator:Nylon 9T,UL94V-0
- *Mates with CJT A2010HC-XP series Housing
- *Color:White

Ordering Information:

- A2010WVC-S-NP - *** - ***
1 2 3
- 1.Part No.
 - 2.Color:
(blank) - Natural
BK - Black
RD - Red
BL - Blue
 - 3.Finish:
(blank) - Tin over Nickel
G - Gold over Nickel

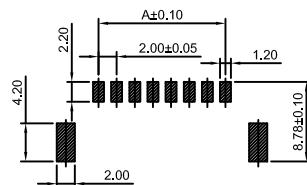
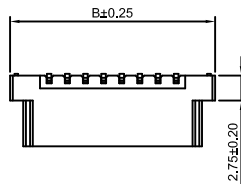
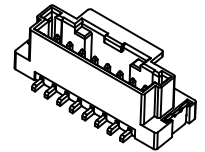

P.C.B LAYOUT

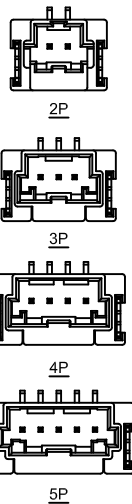
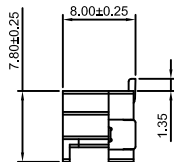
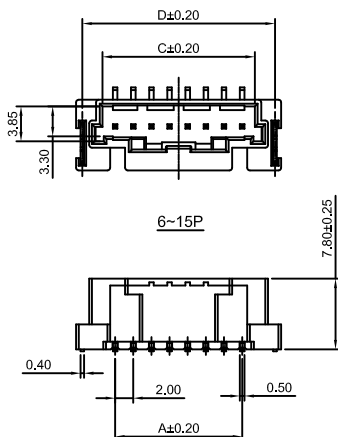

Ordering Information & Dimensions:

PART NO.	Dimensions			
	A	B	C	D
2P	2.00	10.60	4.80	9.23
3P	4.00	12.60	6.80	11.23
4P	6.00	14.60	8.80	13.23
5P	8.00	16.60	10.80	15.23
6P	10.00	18.60	12.80	17.23
7P	12.00	20.60	14.80	19.23
8P	14.00	22.60	16.80	21.23
9P	16.00	24.60	18.80	23.23
10P	18.00	26.60	20.80	25.23
11P	20.00	28.60	22.80	27.23
12P	22.00	30.60	24.80	29.23
13P	24.00	32.60	26.80	31.23
14P	26.00	34.60	28.80	33.23
15P	28.00	36.60	30.80	35.23

Unit: mm

A2010WRC-S-XP

2.00mm Pitch 90° Wafer

Reference Informations:

- *Material:Pin:Brass/Tin over Nickel
Insulator:Nylon 9T,UL94V-0
- *Mates with CJT A2010HC-XP series Housing
- *Color:White

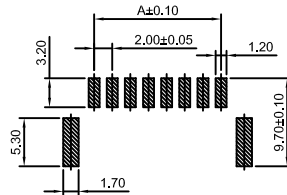
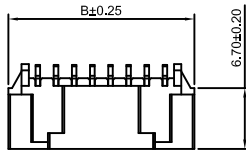
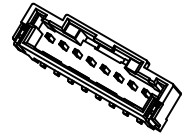

P.C.B LAYOUT

- Ordering Information:
A2010WRC-S-XP - *** - ***
- | | | |
|---|---|---|
| 1 | 2 | 3 |
|---|---|---|
- 1.Part No.
2.Color:
(blank) - Natural
BK - Black
RD - Red
BL - Blue
3.Finish:
(blank) - Tin over Nickel
G - Gold over Nickel

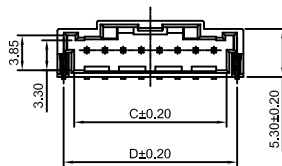

6~15P

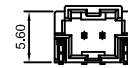
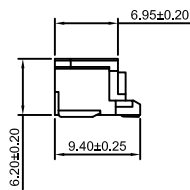

2P

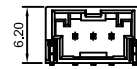

3P

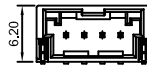

4P



5P

Ordering Information & Dimensions:

PART NO.	Dimensions			
	A	B	C	D
2P	2.00	8.50	4.80	7.13
3P	4.00	10.50	6.80	9.13
4P	6.00	12.50	8.80	11.13
5P	8.00	14.50	10.80	13.13
6P	10.00	16.50	12.80	15.13
7P	12.00	18.50	14.80	17.13
8P	14.00	20.50	16.80	19.13
9P	16.00	22.50	18.80	21.13
10P	18.00	24.50	20.80	23.13
11P	20.00	26.50	22.80	25.13
12P	22.00	28.50	24.80	27.13
13P	24.00	30.50	26.80	29.13
14P	26.00	32.50	28.80	31.13
15P	28.00	34.50	30.80	33.13

Unit: mm