



# SGM8592 Single-Supply, Dual Rail-to-Rail I/O Precision Operational Amplifier

## GENERAL DESCRIPTION

The SGM8592 is a dual rail-to-rail input and output precision operational amplifier which has low input offset voltage and bias current. It is guaranteed to operate from 2.5V to 5.5V single supply.

The rail-to-rail input and output swings provided by the SGM8592 make both high-side and low-side sensing easy. The combination of characteristics makes the SGM8592 a good choice for temperature, position and pressure sensors, medical equipment and strain gauge amplifiers, or any other 2.5V to 5.5V applications requiring precision and long term stability.

The SGM8592 is specified over the extended industrial -40°C to +85°C temperature range. It is available in Green SOIC-8 and MSOP-8 packages.

## APPLICATIONS

- Temperature Measurement
- Pressure Sensor
- Precision Current Sensing
- Electronic Scale
- Strain Gage Amplifier
- Medical Instrumentation
- Thermocouple Amplifier
- Handheld Test Equipment

## FEATURES

- Rail-to-Rail Input and Output Swing
- 2.5V to 5.5V Single Supply Operation
- Voltage Gain: 145dB (TYP) at 5V
- PSRR: 125dB (TYP)
- CMRR: 95dB (TYP)
- Ultra Low Input Bias Current: 15pA
- Low Supply Current: 430µA/Amplifier
- Overload Recovery Time: 70µs (at  $V_S = 5V$ )
- No External Capacitors Required
- -40°C to +85°C Operating Temperature Range
- Available in Green SOIC-8 and MSOP-8 Packages

## PIN CONFIGURATIONS

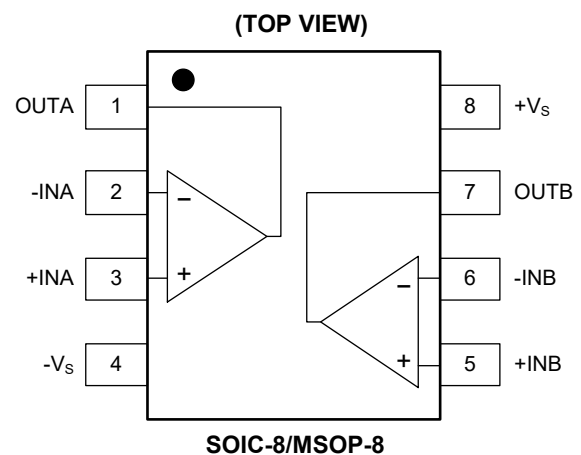

**PACKAGE/ORDERING INFORMATION**

MODEL	PACKAGE DESCRIPTION	SPECIFIED TEMPERATURE RANGE	ORDERING NUMBER	PACKAGE MARKING	PACKING OPTION
SGM8592	SOIC-8	-40°C to +85°C	SGM8592YS8G/TR	SGM8592YS8 XXXXX	Tape and Reel, 2500
	MSOP-8	-40°C to +85°C	SGM8592YMS8G/TR	SGM8592 YMS8 XXXXX	Tape and Reel, 3000

**MARKING INFORMATION**

NOTE: XXXXX = Date Code and Vendor Code.

**XXXXX**

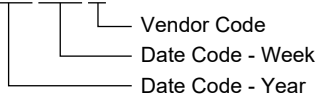

Green (RoHS & HSF): SG Micro Corp defines "Green" to mean Pb-Free (RoHS compatible) and free of halogen substances. If you have additional comments or questions, please contact your SGMICRO representative directly.

**ABSOLUTE MAXIMUM RATINGS**

- Supply Voltage ..... 6V
- Input Voltage Range .....  $-V_S$  to  $(+V_S) + 0.1V$
- Differential Input Voltage Range ..... -5V to 5V
- Package Thermal Resistance @  $T_A = +25^\circ C$
- SOIC-8,  $\theta_{JA}$  .....  $125^\circ C/W$
- Junction Temperature .....  $+150^\circ C$
- Storage Temperature Range .....  $-65^\circ C$  to  $+150^\circ C$
- Lead Temperature (Soldering, 10s) .....  $+260^\circ C$
- ESD Susceptibility
- HBM ..... 4000V
- MM ..... 400V

**RECOMMENDED OPERATING CONDITIONS**

- Operating Temperature Range .....  $-40^\circ C$  to  $+85^\circ C$

**OVERSTRESS CAUTION**

Stresses beyond those listed in Absolute Maximum Ratings may cause permanent damage to the device. Exposure to absolute maximum rating conditions for extended periods may affect reliability. Functional operation of the device at any conditions beyond those indicated in the Recommended Operating Conditions section is not implied.

**ESD SENSITIVITY CAUTION**

This integrated circuit can be damaged if ESD protections are not considered carefully. SGMICRO recommends that all integrated circuits be handled with appropriate precautions. Failure to observe proper handling and installation procedures can cause damage. ESD damage can range from subtle performance degradation to complete device failure. Precision integrated circuits may be more susceptible to damage because even small parametric changes could cause the device not to meet the published specifications.

**DISCLAIMER**

SG Micro Corp reserves the right to make any change in circuit design, or specifications without prior notice.

**ELECTRICAL CHARACTERISTICS**(V<sub>S</sub> = 5V, V<sub>CM</sub> = 2.5V, V<sub>OUT</sub> = 2.5V, Full = -40°C to +85°C, typical values are at T<sub>A</sub> = +25°C, unless otherwise noted.)

PARAMETER	CONDITIONS	TEMP	MIN	TYP	MAX	UNITS
<b>Input Characteristics</b>						
Input Offset Voltage (V <sub>OS</sub> )		+25°C		150	500	μV
		Full			550	
Input Bias Current (I <sub>b</sub> )		+25°C		15		pA
Input Offset Current (I <sub>OS</sub> )		+25°C		10		pA
Input Voltage Range		+25°C	0		5	V
Common Mode Rejection Ratio <sup>(1)</sup> (CMRR)	V <sub>CM</sub> = 0V to 5V	+25°C	80	95		dB
		Full	62			
Large-Signal Voltage Gain (A <sub>VO</sub> )	R <sub>L</sub> = 10kΩ, V <sub>OUT</sub> = 0.3V to 4.7V	+25°C	95	145		dB
		Full	90			
Input Offset Voltage Drift (ΔV <sub>OS</sub> /ΔT)		Full		200		nV/°C
<b>Output Characteristics</b>						
Output Voltage High (V <sub>OH</sub> )	R <sub>L</sub> = 100kΩ to -V <sub>S</sub>	+25°C	4.99	4.998		V
		Full	4.987			
	R <sub>L</sub> = 10kΩ to -V <sub>S</sub>	+25°C	4.98	4.994		V
		Full	4.975			
Output Voltage Low (V <sub>OL</sub> )	R <sub>L</sub> = 100kΩ to +V <sub>S</sub>	+25°C		2	10	mV
		Full			13	
	R <sub>L</sub> = 10kΩ to +V <sub>S</sub>	+25°C		6	15	mV
		Full			20	
Output Short-Circuit Limit (I <sub>sc</sub> )	V <sub>OUT</sub> = 2.5V, R <sub>L</sub> = 10Ω to GND	+25°C	40	45		mA
		Full	21			
<b>Power Supply</b>						
Power Supply Rejection Ratio <sup>(1)</sup> (PSRR)	V <sub>S</sub> = 2.5V to 5.5V	+25°C	90	125		dB
		Full	71			
Quiescent Current/Amplifier (I <sub>Q</sub> )	V <sub>OUT</sub> = V <sub>S</sub> /2	+25°C		430	700	μA
		Full			826	
<b>Dynamic Performance</b>						
Gain-Bandwidth Product (GBP)	A <sub>V</sub> = +100	+25°C		1.5		MHz
Slew Rate (SR)	A <sub>V</sub> = +1, R <sub>L</sub> = 10kΩ, 2V output step	+25°C		0.9		V/μs
Overload Recovery Time	A <sub>V</sub> = -100, R <sub>L</sub> = 10kΩ, V <sub>IN</sub> = 200mV (RET to GND)	+25°C		0.07		ms
<b>Noise Performance</b>						
Input Voltage Noise	0.1Hz to 10Hz	+25°C		0.8		μV <sub>P-P</sub>
Input Voltage Noise Density (e <sub>n</sub> )	f = 1kHz	+25°C		49		nV/√Hz

NOTE: 1. PSRR and CMRR are affected by the matching between external gain-setting resistor ratios.

**ELECTRICAL CHARACTERISTICS (continued)**(V<sub>S</sub> = 2.5V, V<sub>CM</sub> = 1.25V, V<sub>OUT</sub> = 1.25V, Full = -40°C to +85°C, typical values are at T<sub>A</sub> = +25°C, unless otherwise noted.)

PARAMETER	CONDITIONS	TEMP	MIN	TYP	MAX	UNITS
<b>Input Characteristics</b>						
Input Offset Voltage (V <sub>OS</sub> )		+25°C		150	500	μV
		Full			550	
Input Bias Current (I <sub>b</sub> )		+25°C		15		pA
Input Offset Current (I <sub>OS</sub> )		+25°C		10		pA
Input Voltage Range		+25°C	0		2.5	V
Common Mode Rejection Ratio <sup>(1)</sup> (CMRR)	V <sub>CM</sub> = 0V to 2.5V	+25°C	75	95		dB
		Full	68			
Large-Signal Voltage Gain (A <sub>VO</sub> )	R <sub>L</sub> = 10kΩ, V <sub>OUT</sub> = 0.3V to 2.4V	+25°C	95	140		dB
		Full	90			
Input Offset Voltage Drift (ΔV <sub>OS</sub> /ΔT)		Full		200		nV/°C
<b>Output Characteristics</b>						
Output Voltage High (V <sub>OH</sub> )	R <sub>L</sub> = 100kΩ to -V <sub>S</sub>	+25°C	2.49	2.498		V
		Full	2.487			
	R <sub>L</sub> = 10kΩ to -V <sub>S</sub>	+25°C	2.48	2.497		V
		Full	2.476			
Output Voltage Low (V <sub>OL</sub> )	R <sub>L</sub> = 100kΩ to +V <sub>S</sub>	+25°C		1	10	mV
		Full			12	
	R <sub>L</sub> = 10kΩ to +V <sub>S</sub>	+25°C		3	15	mV
		Full			18	
Output Short-Circuit Limit (I <sub>SC</sub> )	V <sub>OUT</sub> = 1.25V, R <sub>L</sub> = 10Ω to GND	+25°C	20	27		mA
		Full	14			
<b>Power Supply</b>						
Power Supply Rejection Ratio <sup>(1)</sup> (PSRR)	V <sub>S</sub> = 2.5V to 5.5V	+25°C	90	125		dB
		Full	71			
Quiescent Current/Amplifier (I <sub>Q</sub> )	V <sub>OUT</sub> = V <sub>S</sub> /2	+25°C		430	700	μA
		Full			831	
<b>Dynamic Performance</b>						
Gain-Bandwidth Product (GBP)	A <sub>V</sub> = +100	+25°C		1.5		MHz
Slew Rate (SR)	A <sub>V</sub> = +1, R <sub>L</sub> = 10kΩ, 2V output step	+25°C		0.9		V/μs
Overload Recovery Time	A <sub>V</sub> = -100, R <sub>L</sub> = 10kΩ, V <sub>IN</sub> = 200mV (RET to GND)	+25°C		0.04		ms
<b>Noise Performance</b>						
Input Voltage Noise	0.1Hz to 10Hz	+25°C		1		μV <sub>P-P</sub>
Input Voltage Noise Density (e <sub>n</sub> )	f = 1kHz	+25°C		56		nV/√Hz

NOTE: 1. PSRR and CMRR are affected by the matching between external gain-setting resistor ratios.

TYPICAL PERFORMANCE CHARACTERISTICS

Large Signal Transient Response at +5V

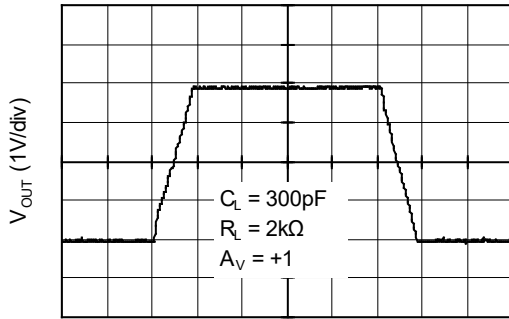

Time (5µs/div)

Large Signal Transient Response at +2.5V

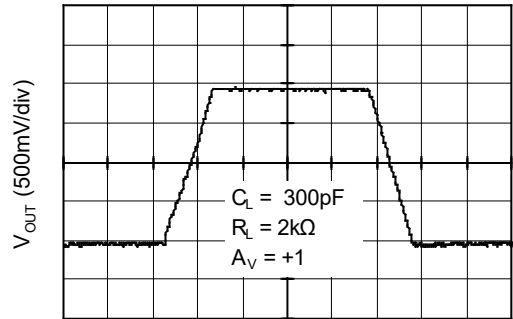

Time (2µs/div)

Small Signal Transient Response at +5V

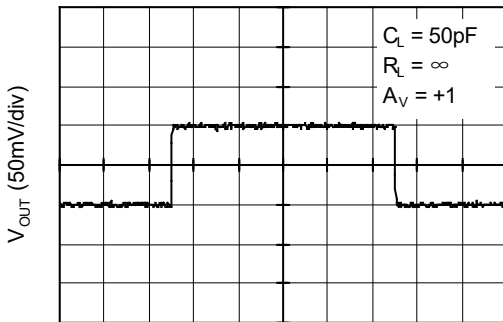

Time (5µs/div)

Small Signal Transient Response at +2.5V

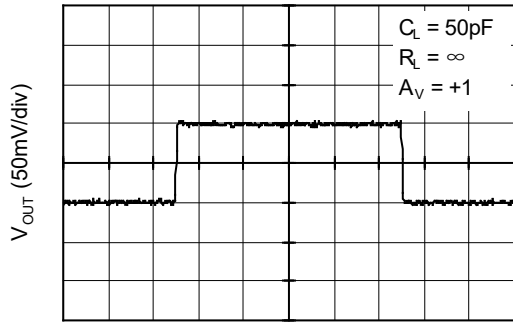

Time (5µs/div)

Closed Loop Gain vs. Frequency at +5V

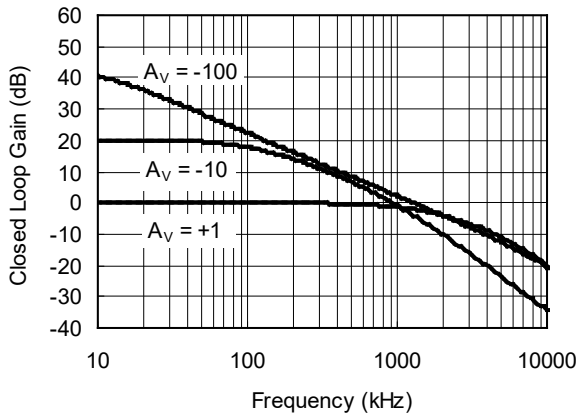

Closed Loop Gain vs. Frequency at +2.5V

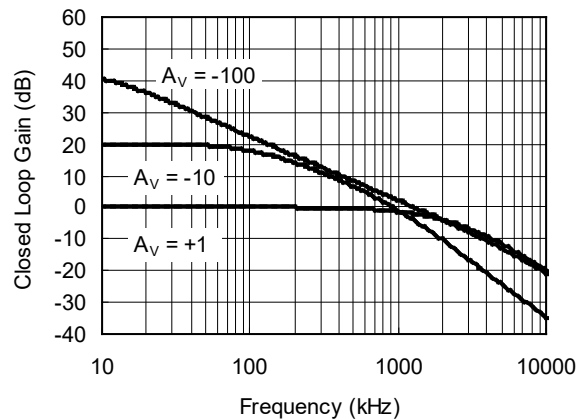

TYPICAL PERFORMANCE CHARACTERISTICS (continued)

0.1Hz to 10Hz Noise at +5V

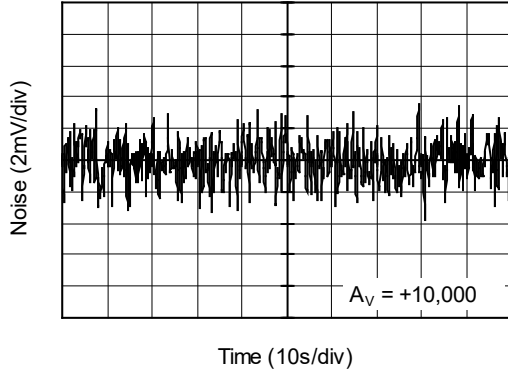

0.1Hz to 10Hz Noise at +2.5V

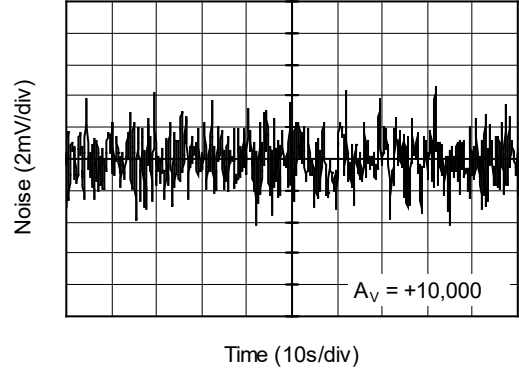

Negative Overvoltage Recovery

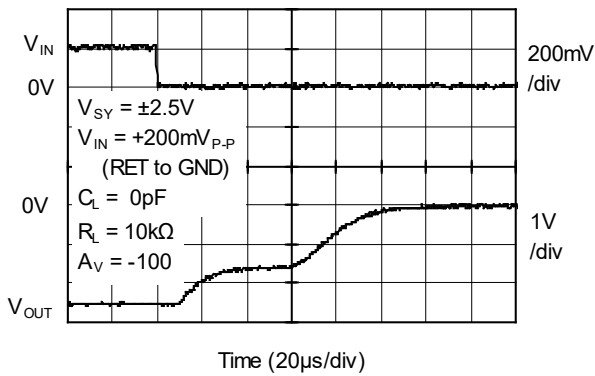

Positive Overvoltage Recovery

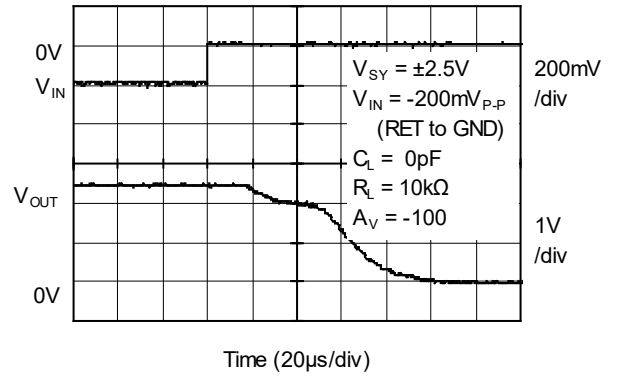

Open Loop Gain, Phase Shift vs. Frequency at +5V

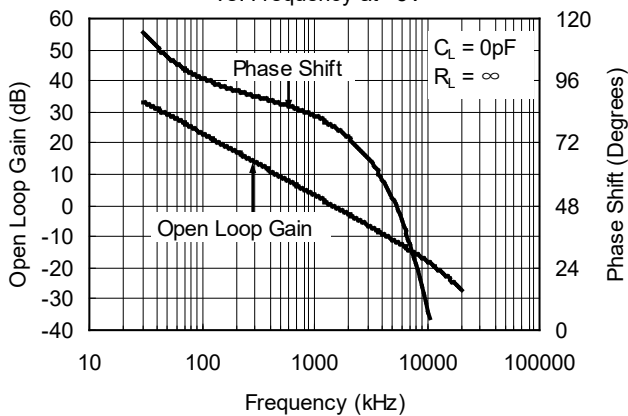

Open Loop Gain, Phase Shift vs. Frequency at +2.5V

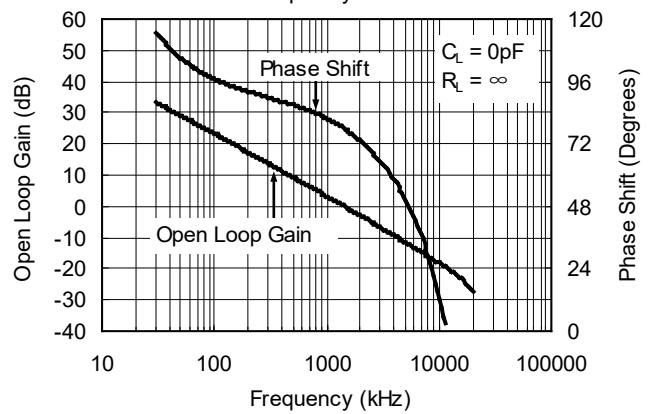

TYPICAL PERFORMANCE CHARACTERISTICS (continued)

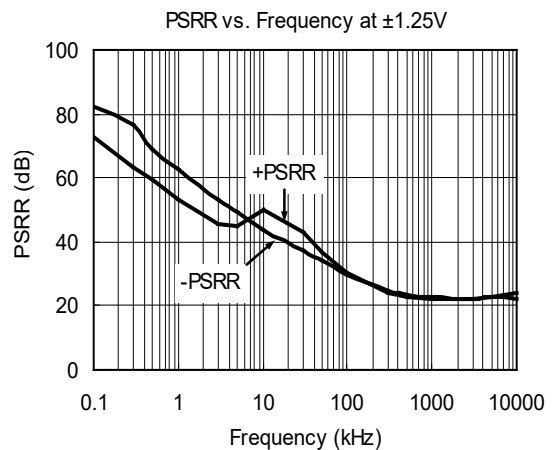
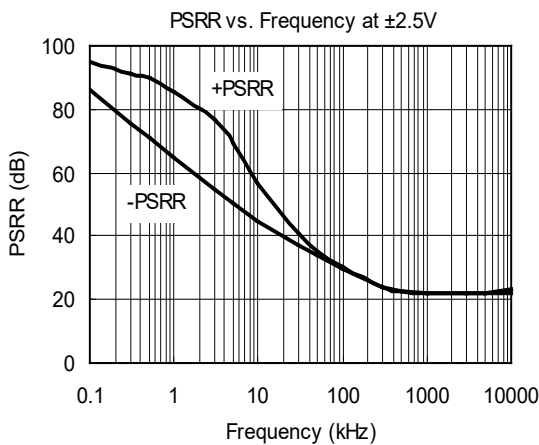
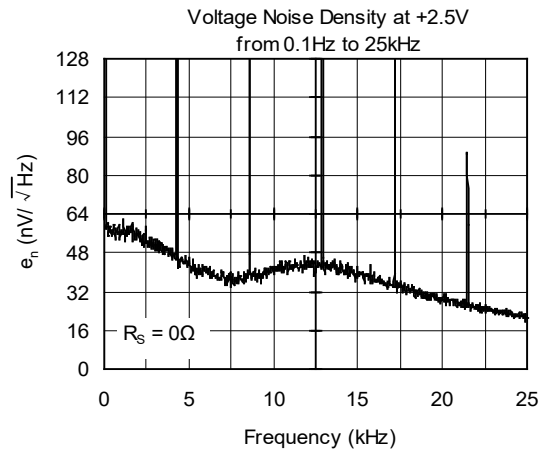
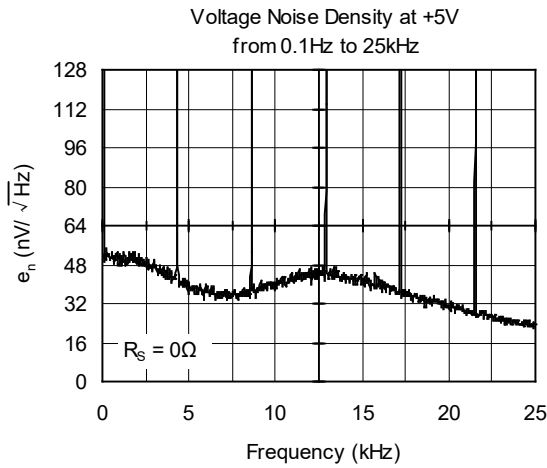
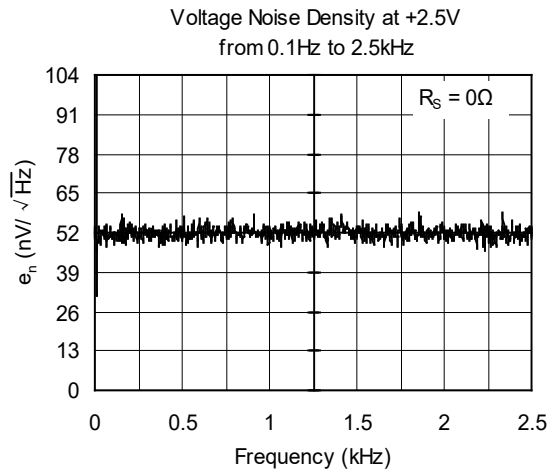
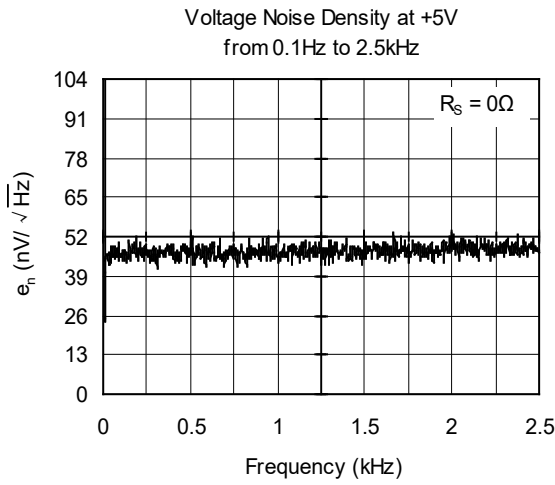

TYPICAL PERFORMANCE CHARACTERISTICS (continued)

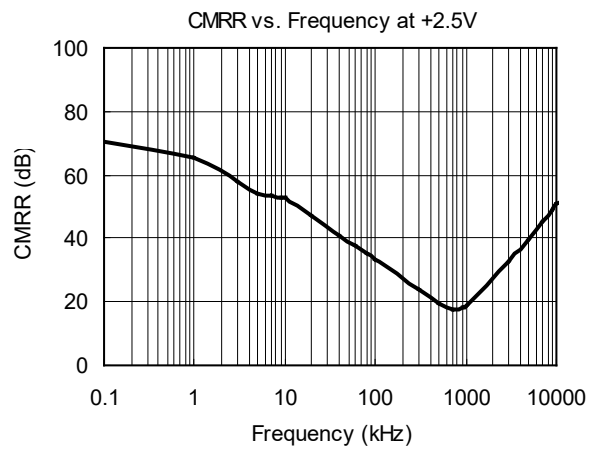
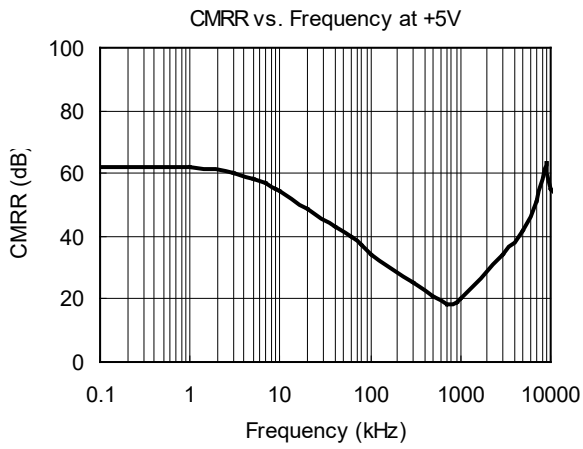

REVISION HISTORY

NOTE: Page numbers for previous revisions may differ from page numbers in the current version.

Changes from Original (JANUARY 2013) to REV.A	Page
Changed from product preview to production data.....	All



PACKAGE OUTLINE DIMENSIONS

SOIC-8

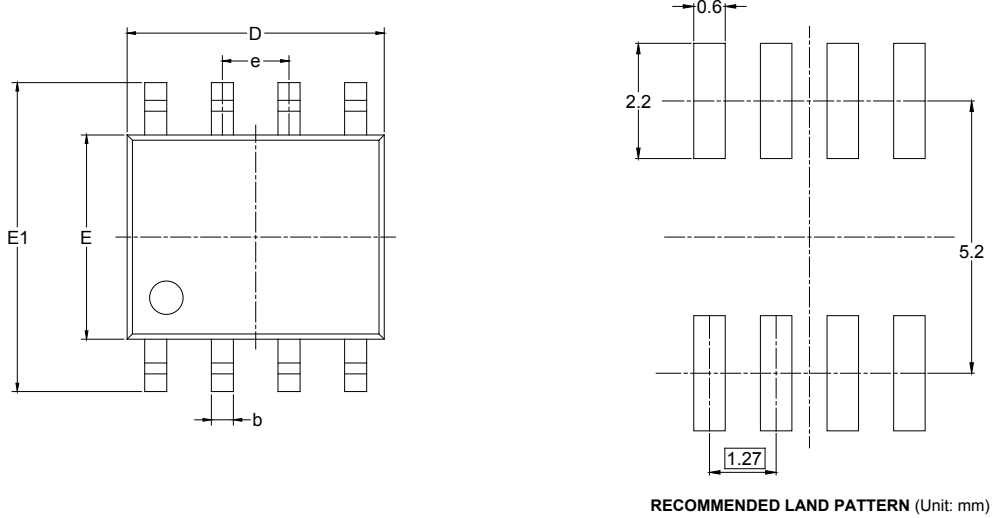

Symbol	Dimensions In Millimeters		Dimensions In Inches	
	MIN	MAX	MIN	MAX
A	1.350	1.750	0.053	0.069
A1	0.100	0.250	0.004	0.010
A2	1.350	1.550	0.053	0.061
b	0.330	0.510	0.013	0.020
c	0.170	0.250	0.006	0.010
D	4.700	5.100	0.185	0.200
E	3.800	4.000	0.150	0.157
E1	5.800	6.200	0.228	0.244
e	1.27 BSC		0.050 BSC	
L	0.400	1.270	0.016	0.050
$\theta$	0°	8°	0°	8°

PACKAGE OUTLINE DIMENSIONS

MSOP-8

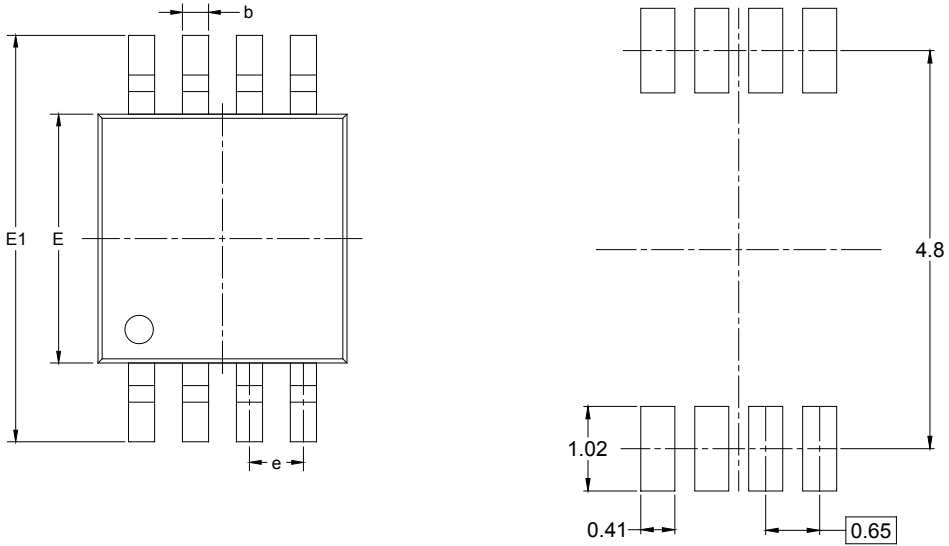

RECOMMENDED LAND PATTERN (Unit: mm)

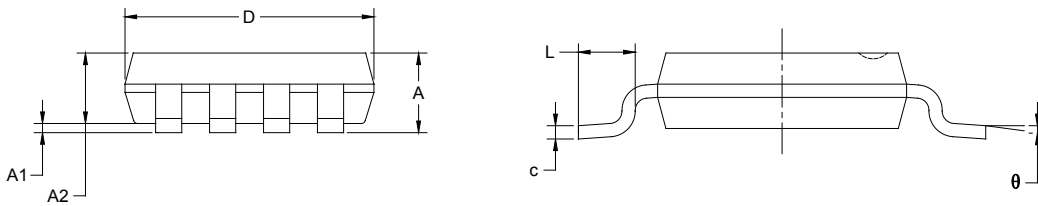

Symbol	Dimensions In Millimeters		Dimensions In Inches	
	MIN	MAX	MIN	MAX
A	0.820	1.100	0.032	0.043
A1	0.020	0.150	0.001	0.006
A2	0.750	0.950	0.030	0.037
b	0.250	0.380	0.010	0.015
c	0.090	0.230	0.004	0.009
D	2.900	3.100	0.114	0.122
E	2.900	3.100	0.114	0.122
E1	4.750	5.050	0.187	0.199
e	0.650 BSC		0.026 BSC	
L	0.400	0.800	0.016	0.031
θ	0°	6°	0°	6°

**TAPE AND REEL INFORMATION**

**REEL DIMENSIONS**



**TAPE DIMENSIONS**



NOTE: The picture is only for reference. Please make the object as the standard.

**KEY PARAMETER LIST OF TAPE AND REEL**

Package Type	Reel Diameter	Reel Width W1 (mm)	A0 (mm)	B0 (mm)	K0 (mm)	P0 (mm)	P1 (mm)	P2 (mm)	W (mm)	Pin1 Quadrant
SOIC-8	13"	12.4	6.40	5.40	2.10	4.0	8.0	2.0	12.0	Q1
MSOP-8	13"	12.4	5.20	3.30	1.50	4.0	8.0	2.0	12.0	Q1

DD0001

# PACKAGE INFORMATION

## CARTON BOX DIMENSIONS



NOTE: The picture is only for reference. Please make the object as the standard.

## KEY PARAMETER LIST OF CARTON BOX

Reel Type	Length (mm)	Width (mm)	Height (mm)	Pizza/Carton
13"	386	280	370	5

DD0002