



# SGM8551XN

## Single-Supply, Single Rail-to-Rail I/O Precision Operational Amplifier

### PRODUCT DESCRIPTION

The SGM8551XN is a single rail-to-rail input and output precision operational amplifier which has low input offset voltage, and bias current. It is guaranteed to operate from 2.5V to 5.5V single supply.

The rail-to-rail input and output swings provided by the SGM8551XN make both high-side and low-side sensing easy. The combination of characteristics makes the SGM8551XN good choices for temperature, position and pressure sensors, medical equipment and strain gauge amplifiers, or any other 2.5V to 5.5V application requiring precision and long term stability.

The SGM8551XN is specified for the extended industrial/automotive (-40°C to +125°C) temperature range. It is available in the Green SOT-23-5 package.

### APPLICATIONS

Temperature Measurements  
Pressure Sensors  
Precision Current Sensing  
Electronic Scales  
Strain Gauge Amplifiers  
Medical Instrumentation  
Thermocouple Amplifiers  
Handheld Test Equipment

### FEATURES

- **Low Offset Voltage:** 12 $\mu$ V (TYP) at +5V
- **Rail-to-Rail Input and Output Swing**
- **2.5V to 5.5V Single Supply Operation**
- **Voltage Gain:** 145dB (TYP) at +5V
- **PSRR:** 110dB (TYP)
- **CMRR:** 105dB (TYP)
- **Ultra Low Input Bias Current:** 19pA
- **Low Supply Current:** 465 $\mu$ A (TYP)
- **Overload Recovery Time:** 0.1ms (at  $V_S = +5V$ )
- **No External Capacitors Required**
- **-40°C to +125°C Operating Temperature Range**
- **Available in Green SOT-23-5 Package**

### PIN CONFIGURATION (TOP VIEW)

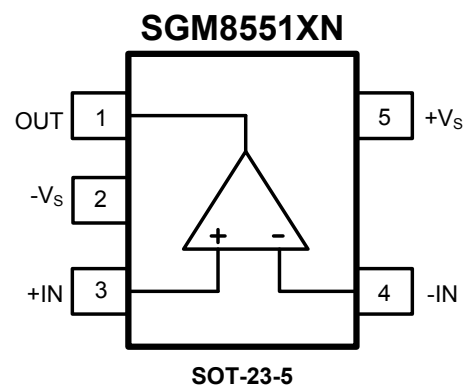

# Single-Supply, Single Rail-to-Rail I/O Precision Operational Amplifier

## SGM8551XN

### PACKAGE/ORDERING INFORMATION

MODEL	ORDER NUMBER	PACKAGE DESCRIPTION	PACKAGE OPTION	MARKING INFORMATION
SGM8551XN	SGM8551XN5G/TR	SOT-23-5	Tape and Reel, 3000	S06XX

NOTE: Package marking is defined as the follow:

#### MARKING INFORMATION

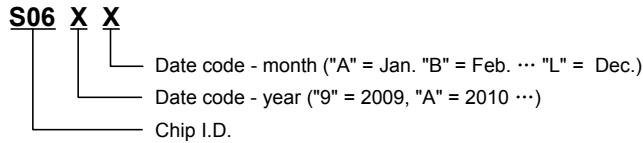

For example: S069A (2009, January)

### ABSOLUTE MAXIMUM RATINGS

Supply Voltage	6V
Input Voltage	$-V_S$ to $(+V_S) + 0.1V$
Differential Input Voltage	-5V to 5V
Storage Temperature Range	-65°C to +150°C
Junction Temperature	150°C
Operating Temperature Range	-40°C to +125°C
Lead Temperature (Soldering 10sec)	260°C
ESD Susceptibility	
HBM	4000V
MM	400V

#### NOTE:

Stresses beyond those listed under "Absolute Maximum Ratings" may cause permanent damage to the device. These are stress ratings only, and functional operation of the device at these or any other conditions beyond those indicated in the operational sections of the specifications is not implied. Exposure to absolute maximum rating conditions for extended periods may affect device reliability.

### CAUTION

This integrated circuit can be damaged by ESD if you don't pay attention to ESD protection. SGMICRO recommends that all integrated circuits be handled with appropriate precautions. Failure to observe proper handling and installation procedures can cause damage. ESD damage can range from subtle performance degradation to complete device failure. Precision integrated circuits may be more susceptible to damage because very small parametric changes could cause the device not to meet its published specifications.

SGMICRO reserves the right to make any change in circuit design, specification or other related things if necessary without notice at any time. Please contact SGMICRO sales office to get the latest datasheet.

**ELECTRICAL CHARACTERISTICS**(V<sub>S</sub> = +5V, V<sub>CM</sub> = +2.5V, V<sub>O</sub> = +2.5V, T<sub>A</sub> = +25°C, unless otherwise noted.)

PARAMETER	CONDITIONS	MIN	TYP	MAX	UNITS
<b>INPUT CHARACTERISTICS</b>					
Input Offset Voltage (V <sub>OS</sub> )			12	20	μV
	-40°C ≤ T <sub>A</sub> ≤ +125°C			28	
Input Bias Current (I <sub>B</sub> )			19		pA
Input Offset Current (I <sub>OS</sub> )			3		pA
Input Voltage Range		0		5	V
Common Mode Rejection Ratio <sup>(1)</sup> (CMRR)	V <sub>CM</sub> = 0V to 5V	90	105		dB
	-40°C ≤ T <sub>A</sub> ≤ +125°C	86			
Large Signal Voltage Gain (A <sub>VO</sub> )	R <sub>L</sub> = 10kΩ, V <sub>O</sub> = 0.3V to 4.7V	100	145		dB
	-40°C ≤ T <sub>A</sub> ≤ +125°C	90			
Input Offset Voltage Drift (ΔV <sub>OS</sub> /ΔT)	-40°C ≤ T <sub>A</sub> ≤ +125°C		20		nV/°C
<b>OUTPUT CHARACTERISTICS</b>					
Output Voltage High (V <sub>OH</sub> )	R <sub>L</sub> = 100kΩ to -V <sub>S</sub>	4.99	4.998		V
	-40°C ≤ T <sub>A</sub> ≤ +125°C	4.987			
	R <sub>L</sub> = 10kΩ to -V <sub>S</sub>	4.985	4.996		V
	-40°C ≤ T <sub>A</sub> ≤ +125°C	4.98			
Output Voltage Low (V <sub>OL</sub> )	R <sub>L</sub> = 100kΩ to +V <sub>S</sub>		2	10	mV
	-40°C ≤ T <sub>A</sub> ≤ +125°C			13	
	R <sub>L</sub> = 10kΩ to +V <sub>S</sub>		6	15	mV
	-40°C ≤ T <sub>A</sub> ≤ +125°C			20	
Short Circuit Limit (I <sub>SC</sub> )	V <sub>O</sub> = 2.5V, R <sub>L</sub> = 10Ω to GND	40	48		mA
	-40°C ≤ T <sub>A</sub> ≤ +125°C	24			
<b>POWER SUPPLY</b>					
Power Supply Rejection Ratio <sup>(1)</sup> (PSRR)	V <sub>S</sub> = 2.5V to 5.5V	90	110		dB
	-40°C ≤ T <sub>A</sub> ≤ +125°C	85			
Quiescent Current (I <sub>Q</sub> )	V <sub>O</sub> = +V <sub>S</sub> /2		465	553	μA
	-40°C ≤ T <sub>A</sub> ≤ +125°C			800	
<b>DYNAMIC PERFORMANCE</b>					
Gain-Bandwidth Product (GBP)	A <sub>V</sub> = +100		1.48		MHz
Slew Rate (SR)	A <sub>V</sub> = +1, R <sub>L</sub> = 10kΩ, 2V Output Step		0.84		V/μs
Overload Recovery Time	A <sub>V</sub> = -100, R <sub>L</sub> = 10kΩ, V <sub>IN</sub> = 200mV (RET to GND)		0.10		ms
<b>NOISE PERFORMANCE</b>					
Voltage Noise (e <sub>n</sub> , p-p)	0.1Hz to 10Hz		0.90		μV <sub>P-P</sub>
Voltage Noise Density (e <sub>n</sub> )	f = 1kHz		53		nV/√Hz

NOTE 1: PSRR and CMRR are affected by the matching between external gain-setting resistor ratios.

**ELECTRICAL CHARACTERISTICS**(V<sub>S</sub> = +2.5V, V<sub>CM</sub> = +1.25V, V<sub>O</sub> = +1.25V, T<sub>A</sub> = +25°C, unless otherwise noted.)

PARAMETER	CONDITIONS	MIN	TYP	MAX	UNITS
<b>INPUT CHARACTERISTICS</b>					
Input Offset Voltage (V <sub>OS</sub> )			9	20	μV
	-40°C ≤ T <sub>A</sub> ≤ +125°C			27	
Input Bias Current (I <sub>B</sub> )			13		pA
Input Offset Current (I <sub>OS</sub> )			5		pA
Input Voltage Range		0		2.5	V
Common Mode Rejection Ratio <sup>(1)</sup> (CMRR)	V <sub>CM</sub> = 0V to 2.5V	90	105		dB
	-40°C ≤ T <sub>A</sub> ≤ +125°C	86			
Large Signal Voltage Gain (A <sub>VO</sub> )	R <sub>L</sub> = 10kΩ, V <sub>O</sub> = 0.3V to 2.4V	100	135		dB
	-40°C ≤ T <sub>A</sub> ≤ +125°C	90			
Input Offset Voltage Drift (ΔV <sub>OS</sub> /ΔT)	-40°C ≤ T <sub>A</sub> ≤ +125°C		20		nV/°C
<b>OUTPUT CHARACTERISTICS</b>					
Output Voltage High (V <sub>OH</sub> )	R <sub>L</sub> = 100kΩ to -V <sub>S</sub>	2.49	2.499		V
	-40°C ≤ T <sub>A</sub> ≤ +125°C	2.489			
	R <sub>L</sub> = 10kΩ to -V <sub>S</sub>	2.485	2.498		V
	-40°C ≤ T <sub>A</sub> ≤ +125°C	2.483			
Output Voltage Low (V <sub>OL</sub> )	R <sub>L</sub> = 100kΩ to +V <sub>S</sub>		1	10	mV
	-40°C ≤ T <sub>A</sub> ≤ +125°C			11	
	R <sub>L</sub> = 10kΩ to +V <sub>S</sub>		3	15	mV
	-40°C ≤ T <sub>A</sub> ≤ +125°C			17	
Short Circuit Limit (I <sub>SC</sub> )	V <sub>O</sub> = 1.25V, R <sub>L</sub> = 10Ω to GND	20	28		mA
	-40°C ≤ T <sub>A</sub> ≤ +125°C	16			
<b>POWER SUPPLY</b>					
Power Supply Rejection Ratio <sup>(1)</sup> (PSRR)	V <sub>S</sub> = 2.5V to 5.5V	90	110		dB
	-40°C ≤ T <sub>A</sub> ≤ +125°C	85			
Quiescent Current (I <sub>Q</sub> )	V <sub>O</sub> = +V <sub>S</sub> /2		498	553	μA
	-40°C ≤ T <sub>A</sub> ≤ +125°C			800	
<b>DYNAMIC PERFORMANCE</b>					
Gain-Bandwidth Product (GBP)	A <sub>V</sub> = +100		1.46		MHz
Slew Rate (SR)	A <sub>V</sub> = +1, R <sub>L</sub> = 10kΩ, 2V Output Step		0.83		V/μs
Overload Recovery Time	A <sub>V</sub> = -100, R <sub>L</sub> = 10kΩ, V <sub>IN</sub> = 200mV (RET to GND)		0.86		ms
<b>NOISE PERFORMANCE</b>					
Voltage Noise (e <sub>n</sub> p-p)	0.1Hz to 10Hz		0.90		μV <sub>P-P</sub>
Voltage Noise Density (e <sub>n</sub> )	f = 1kHz		55		nV/√Hz

NOTE 1: PSRR and CMRR are affected by the matching between external gain-setting resistor ratios.

TYPICAL PERFORMANCE CHARACTERISTICS

Large Signal Transient Response at +5V

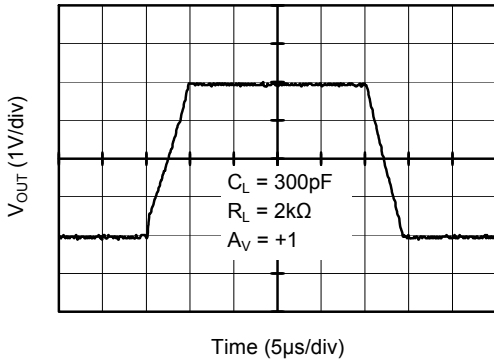

Large Signal Transient Response at +2.5V

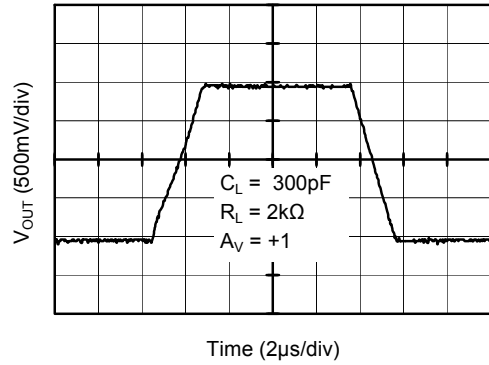

Small Signal Transient Response at +5V

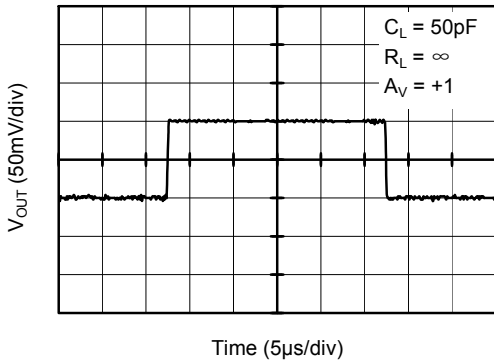

Small Signal Transient Response at +2.5V

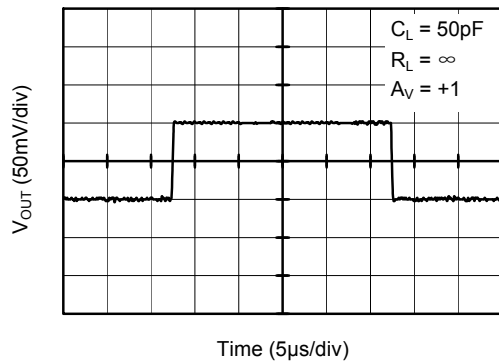

Closed Loop Gain vs. Frequency at +5V

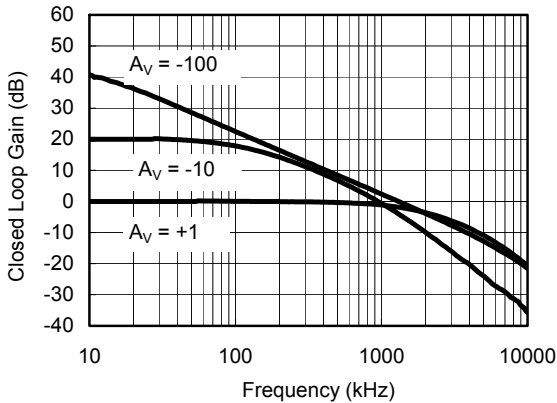

Closed Loop Gain vs. Frequency at +2.5V

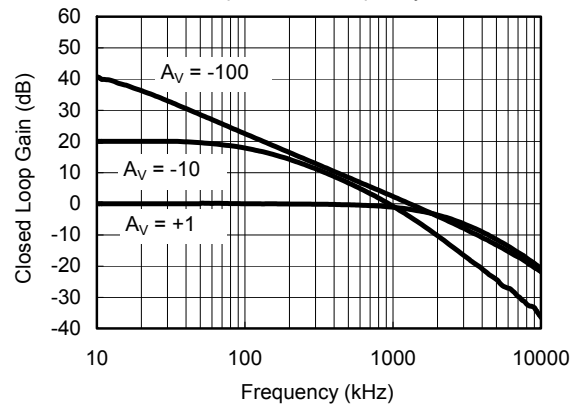

TYPICAL PERFORMANCE CHARACTERISTICS

Positive Overvoltage Recovery

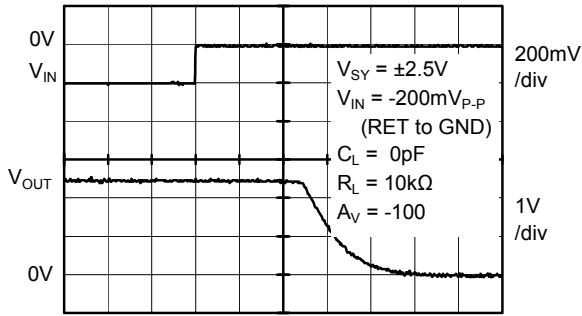

Time (20µs/div)

Negative Overvoltage Recovery

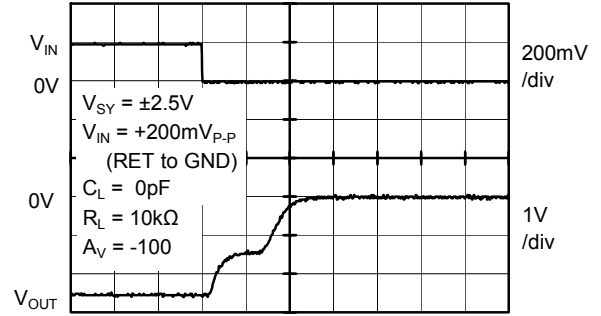

Time (50µs/div)

Open Loop Gain, Phase Shift vs. Frequency at +5V

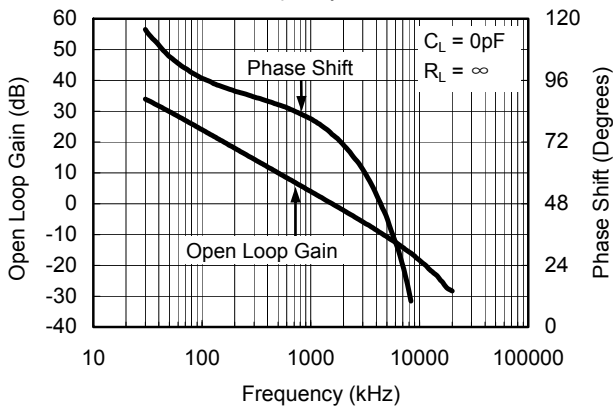

Open Loop Gain, Phase Shift vs. Frequency at +2.5V

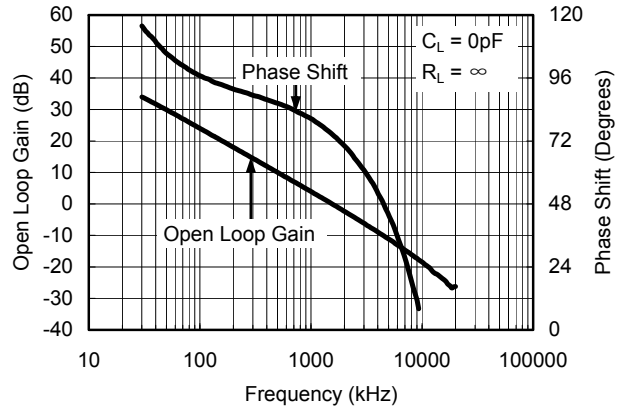

0.1Hz to 10Hz Noise at +5V

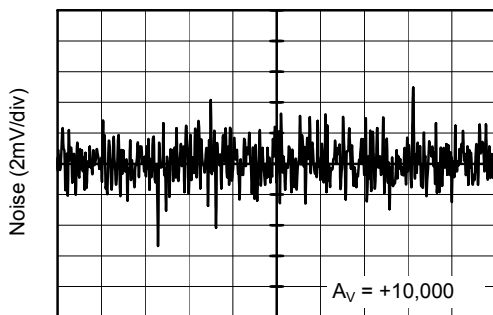

Time (10s/div)

0.1Hz to 10Hz Noise at +2.5V

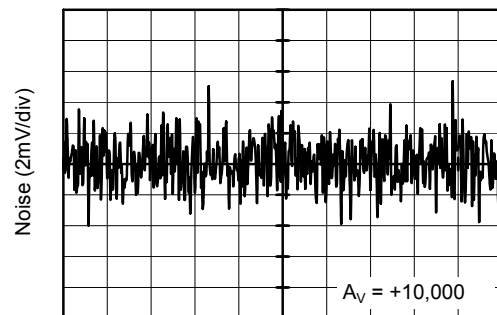

Time (10s/div)

TYPICAL PERFORMANCE CHARACTERISTICS

Voltage Noise Density at +5V  
from 0.1Hz to 2.5kHz

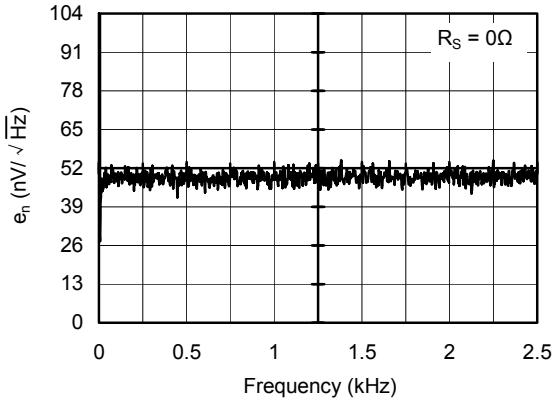

Voltage Noise Density at +2.5V  
from 0.1Hz to 2.5kHz

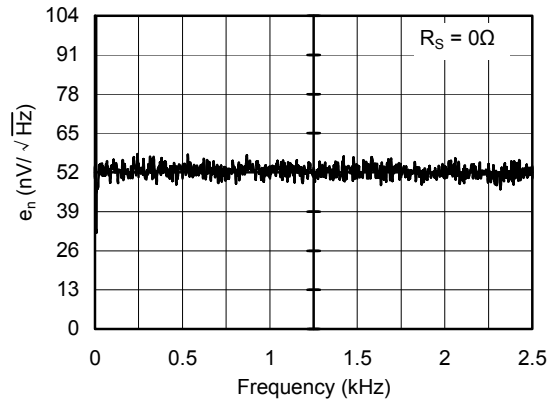

Voltage Noise Density at +5V  
from 0.1Hz to 25kHz

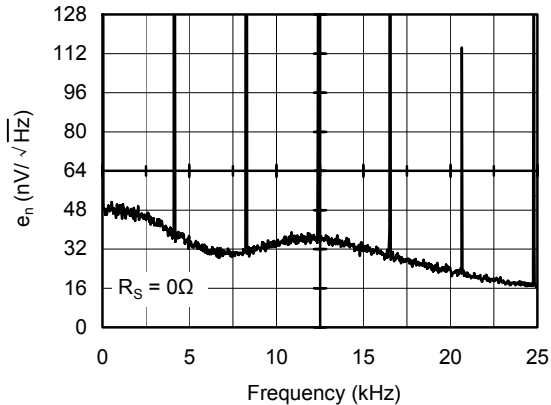

Voltage Noise Density at +2.5V  
from 0.1Hz to 25kHz

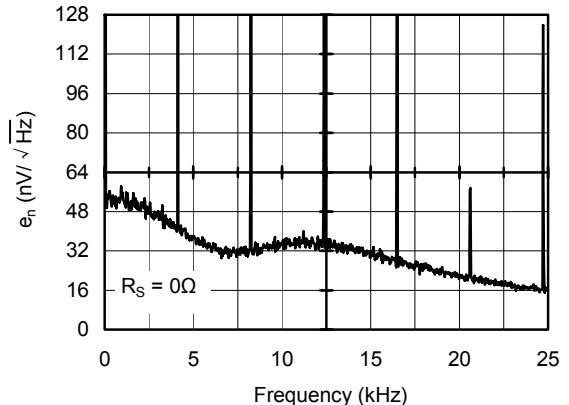

Offset Voltage Production Distribution at +5V

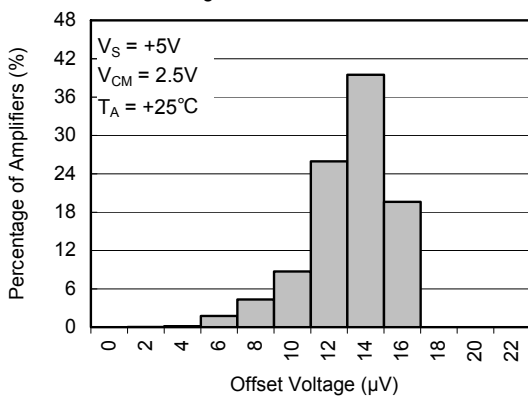

Offset Voltage Production Distribution at +2.5V

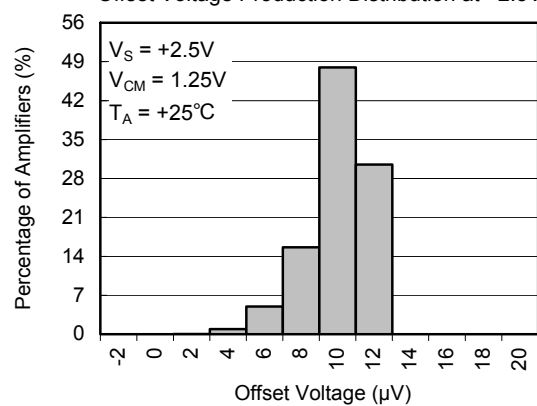

TYPICAL PERFORMANCE CHARACTERISTICS

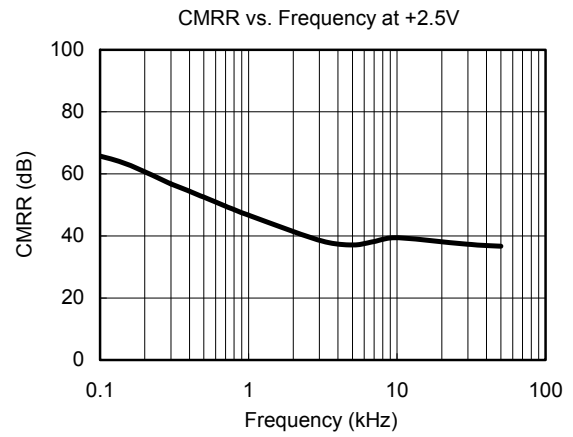
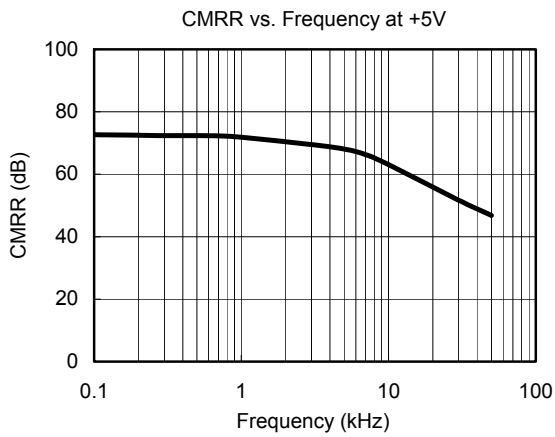



PACKAGE OUTLINE DIMENSIONS

SOT-23-5

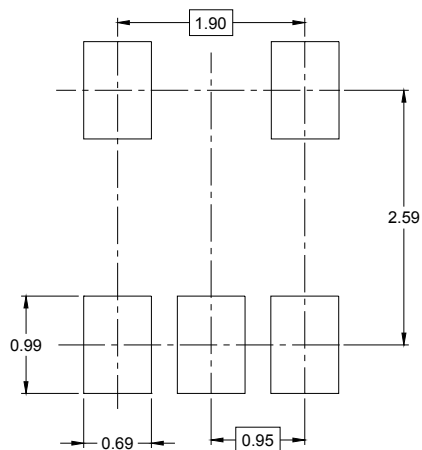
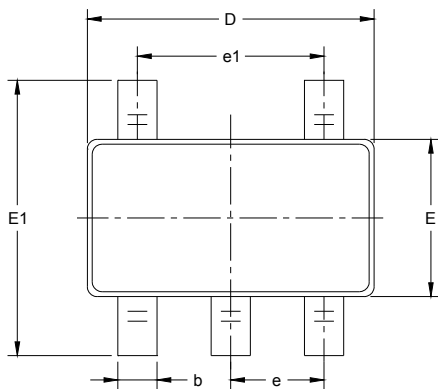

RECOMMENDED LAND PATTERN (Unit: mm)

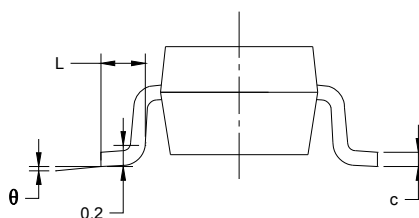
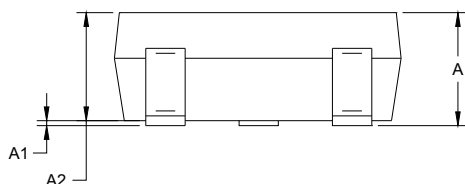

Symbol	Dimensions In Millimeters		Dimensions In Inches	
	MIN	MAX	MIN	MAX
A	1.050	1.250	0.041	0.049
A1	0.000	0.100	0.000	0.004
A2	1.050	1.150	0.041	0.045
b	0.300	0.500	0.012	0.020
c	0.100	0.200	0.004	0.008
D	2.820	3.020	0.111	0.119
E	1.500	1.700	0.059	0.067
E1	2.650	2.950	0.104	0.116
e	0.950 BSC		0.037 BSC	
e1	1.900 BSC		0.075 BSC	
L	0.300	0.600	0.012	0.024
theta	0°	8°	0°	8°

**TAPE AND REEL INFORMATION**

**REEL DIMENSIONS**

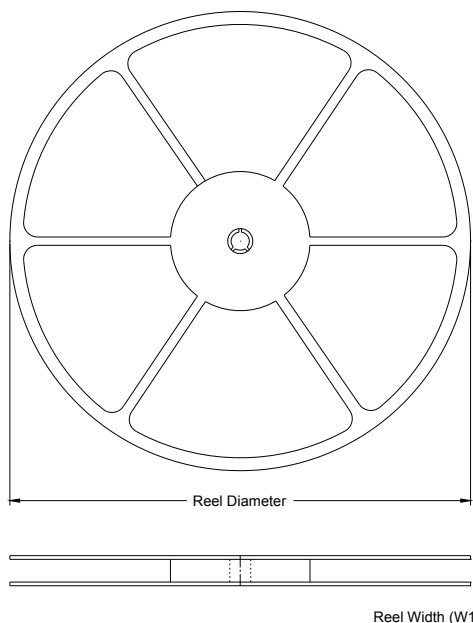

**TAPE DIMENSIONS**

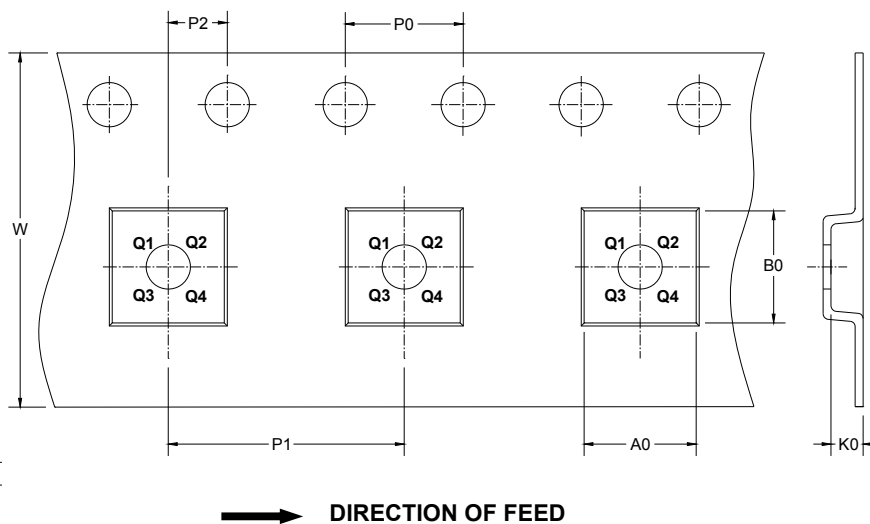

NOTE: The picture is only for reference. Please make the object as the standard.

**KEY PARAMETER LIST OF TAPE AND REEL**

Package Type	Reel Diameter	Reel Width W1 (mm)	A0 (mm)	B0 (mm)	K0 (mm)	P0 (mm)	P1 (mm)	P2 (mm)	W (mm)	Pin1 Quadrant
SOT-23-5	7"	9.5	3.2	3.2	1.4	4.0	4.0	2.0	8.0	Q3

# SGM8551XN

# Single-Supply, Single Rail-to-Rail I/O Precision Operational Amplifier

## CARTON BOX DIMENSIONS

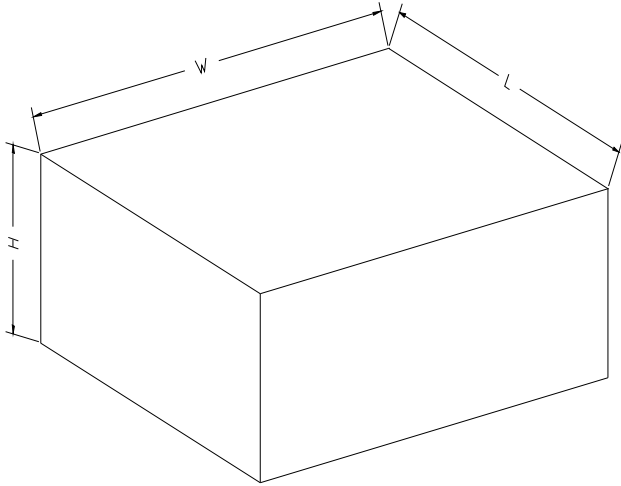

NOTE: The picture is only for reference. Please make the object as the standard.

## KEY PARAMETER LIST OF CARTON BOX

Reel Type	Length (mm)	Width (mm)	Height (mm)	Pizza/Carton
7" (Option)	368	227	224	8
7"	442	410	224	18