

MYC-C437X CPU Module

- Up to 1GHz TI AM437x Series ARM Cortex-A9 Processors
- 512MB DDR3 SDRAM, 4GB eMMC Flash, 32KB EEPROM
- Gigabit Ethernet PHY
- Power Management IC
- Two 0.8mm pitch 100-pin Board-to-Board Expansion Connectors
- Ready-to-Run Linux 4.1.18

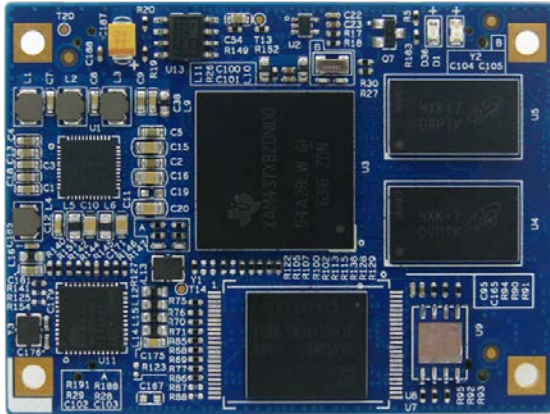

Figure 1-1 MYC-C437X CPU Module Top-view

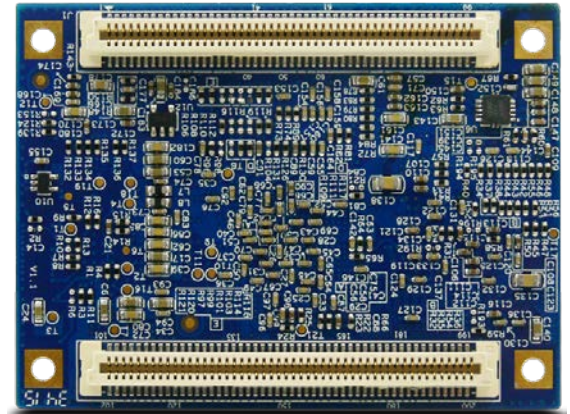

Figure 1-2 MYC-C437X CPU Module Bottom-view

The MYC-C437X CPU Module is a low-cost compact-sized SOM (System on Module) based on 1GHz Sitara AM437x (AM4376, AM4377, AM4378, AM4379) ARM Cortex-A9 processors from Texas Instruments (TI), featuring 3D graphics acceleration for rich graphical user interfaces, PRU-ICSS for industrial protocols, improved Vector Floating Point (VFP) unit and other peripherals and interfaces support like Quad-SPI, dual parallel cameras, two independent eight-channel ADCs, etc.

The MYC-C437X CPU Module integrates the AM437x processor, 512MB DDR3 SDRAM, 4GB eMMC Flash, 32KB EEPROM, Gigabit Ethernet PHY and Power Management IC TPS65218 on board and can be served as the controller board of your next design. It has two 0.8mm pitch 2*50-pin board-to-board expansion connectors for interconnecting with your base board, thus providing an interface for the base board to carry most of the I/O signals to and from the CPU module.

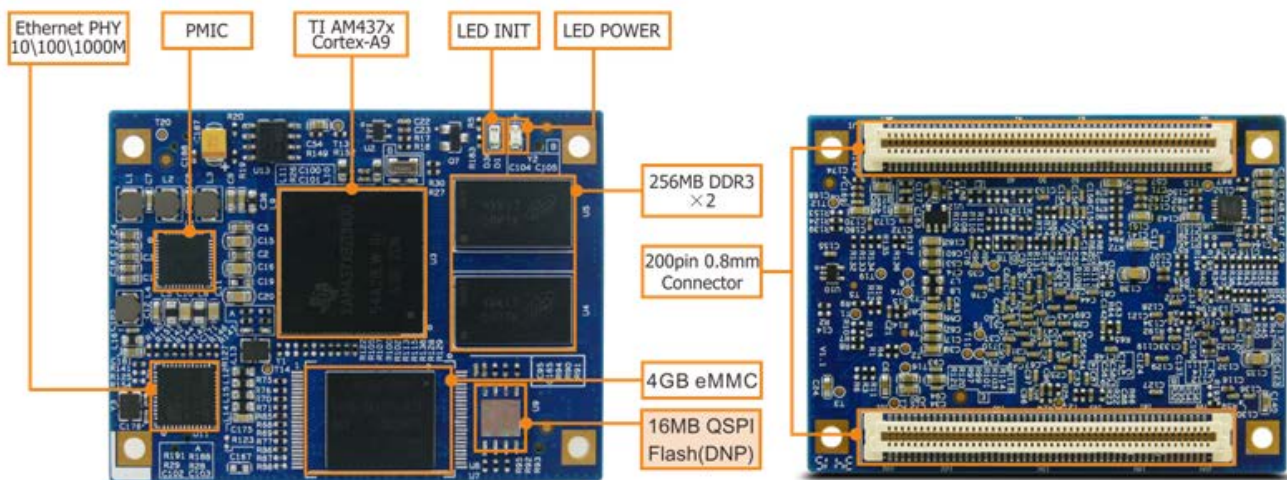

Figure 1-3 MYC-C437X CPU Module

The MYC-AM437X CPU Module series have four models with different AM437x processors. They are sharing the same pin-out with software fully compatible. MYIR delivers the MYC-C4378 by default. Other three models are only available for mass quantity demand.

You can get to know the main differences of the four AM437x Sitara ARM Cortex-A9 processors from below image.

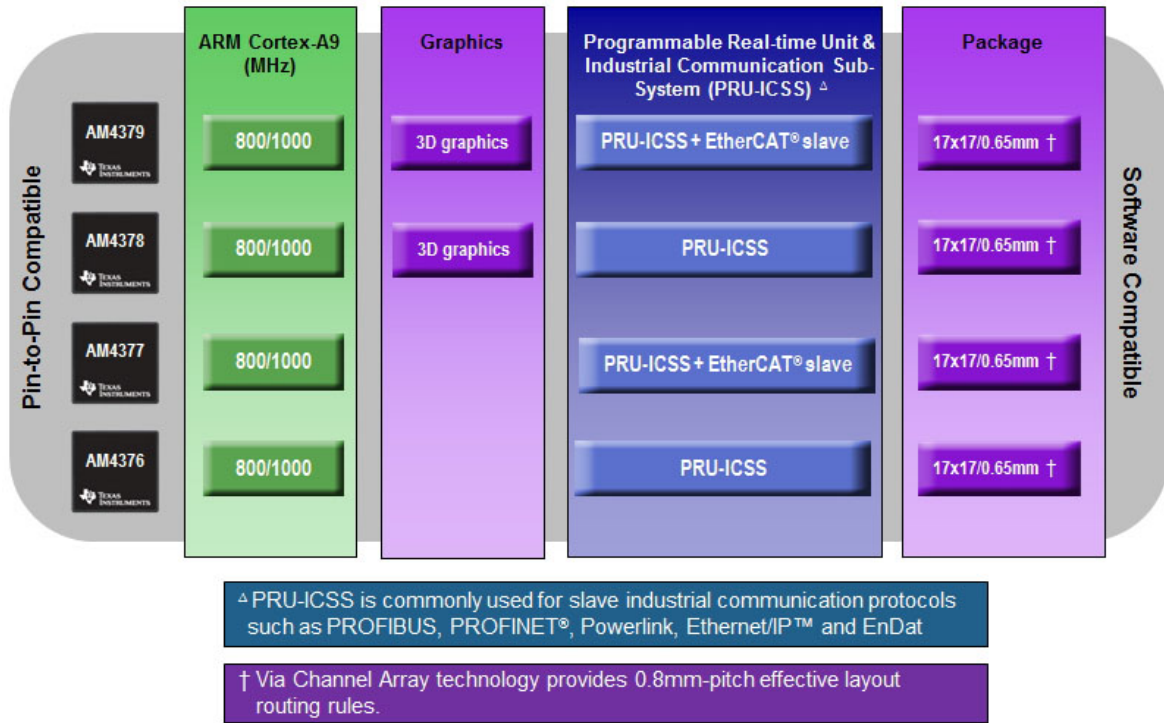

Figure 1-4 AM437x Devices Comparison

The MYD-C437X is a fully-featured development board for the MYC-C437X CPU Module. The base board has brought out rich peripheral sets interfaces including two serial ports, four USB Host ports, one USB OTG port, dual Gigabit Ethernet ports, two CAN, one RS485, one Micro SD, two camera, HDMI, LCD, Touch screen, JTAG and more others.

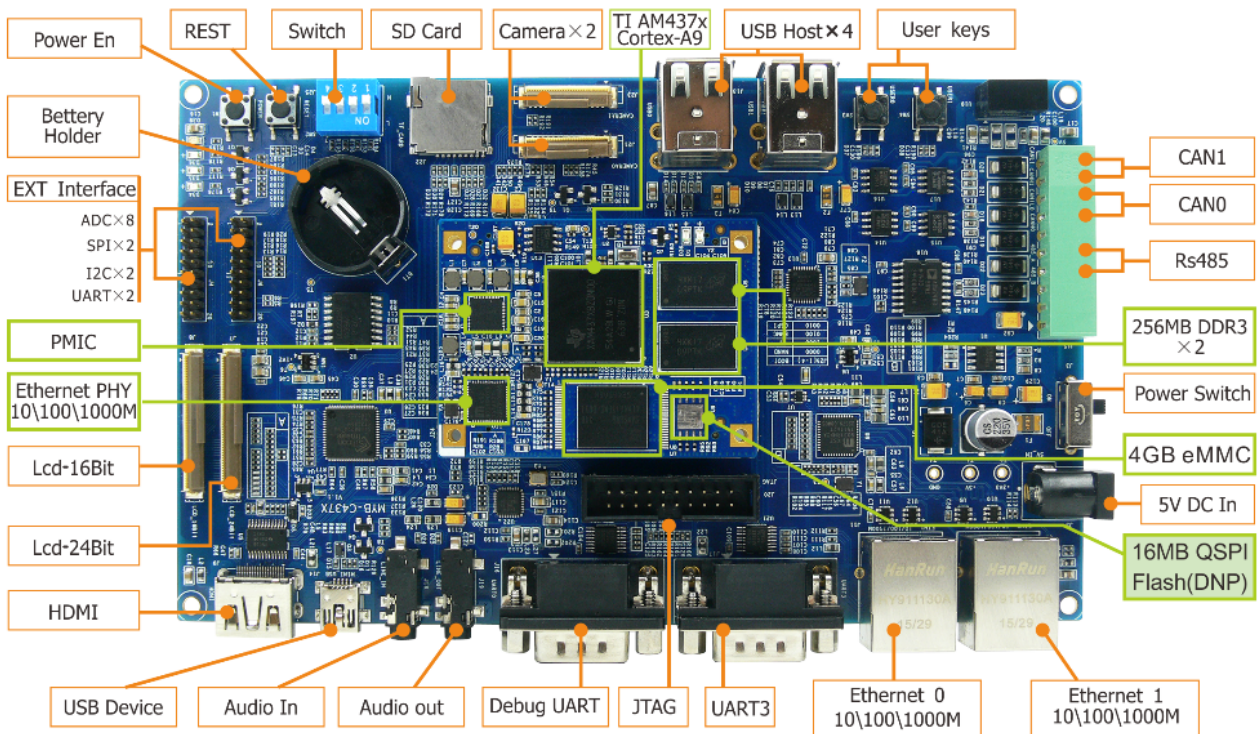
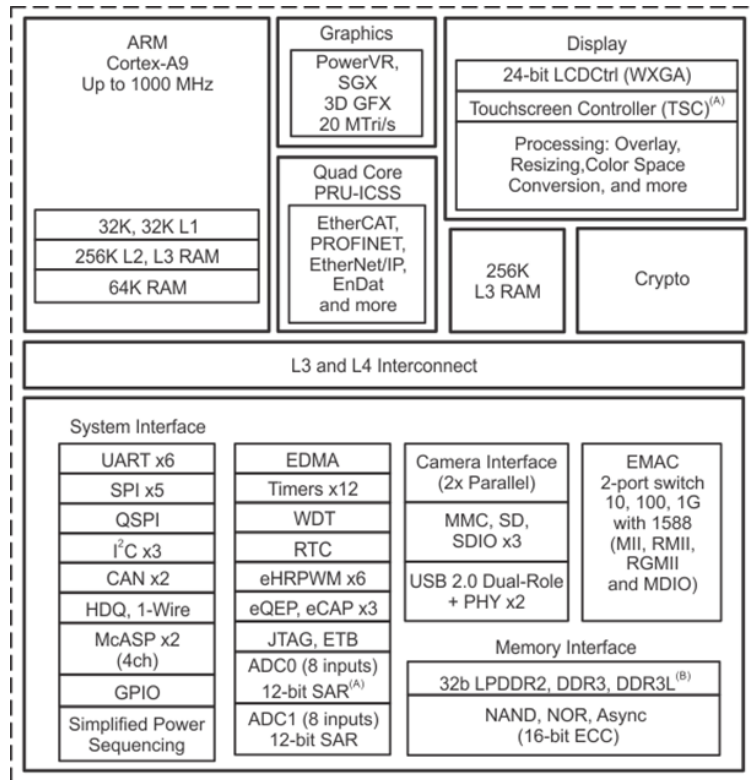

Figure 1-5 MYD-C437X Development Board

MYIR has ported Linux 4.1.18 OS for the MYD-C437X board. The MYC-C437X CPU module will come with a product disk which contains the detailed user manual, datasheet and software package. The modules can be used in various applications such as medical devices, navigation equipment, bar code scanner, test and measurement and industrial control applications.

Hardware Specification

The TI AM437x high-performance processors are based on the ARM Cortex-A9 core. Customers using this next generation solution will see an increase in performance, as well as extensive reuse from the ARM Cortex-A8 offerings.



A. Use of TSC will limit available ADC0 inputs.

B. Max clock: LPDDR2 = 266 MHz; DDR3/DDR3L = 400 MHz

Figure 1-6 AM437x Function Block Diagram

Increasing performance and peripheral support

Sitara AM437x processors deliver the right balance of:

Performance

- Up to 1GHz of processing power
- 3D graphics accelerator
- On-chip quad-core PRU co-processor for real-time processing
- Improved vector floating-point unit

Interfaces

- LPDDR2/DDR3
- QSPI
- Display subsystem

Connectivity

- Two parallel camera ports

- Dual-port 1Gb Ethernet switch
- Two independent, eight-channel ADCs
- WiLink connectivity drivers
- Industrial protocols via PRU-ICSS

Mechanical Parameters

- Dimensions: 60mm x 45mm
- PCB Layers: 8-layer design
- Power supply: +5V/2A
- Static power: about 5V/0.33A
- Working temperature: 0~70 Celsius (commercial grade) or -40~85 Celsius (industrial grade)

Processor

- TI AM437x (AM4376, AM4377, AM4378, AM4379)
 - Up to 1GHz Sitara ARM Cortex-A9 32-Bit RISC processor
 - POWERVR SGX Graphics Accelerator subsystem for 3D graphics acceleration to support display and gaming effects
 - Single-cycle vector floating point (VFP)
 - Dual camera and display processing subsystem
 - Cryptographic acceleration and secure boot
 - PRU-ICSS enables simultaneous industrial Ethernet protocols and motor feedback protocols
 - Support for 32 bit LPDDR2/DDR3/DDR3L
 - Low power: ~5mW deep sleep and < 0.1mW RTC-only
 - Simplified power sequence for flexible power designs

Memory

- 256MB DDR3 SDRAM (512MB is optional)
- 4GB eMMC Flash (reserved 256/512MB Nand Flash design)
- 16MB QSPI Flash (reserved design, not soldered on board)
- 32KB EEPROM

Peripherals and Signals Routed to Pins

[MYC-C437x Pinouts Description](#)

- Power Management IC (TPS65218B1RSLR)
- Gigabit Ethernet PHY
- One power indicator (Red LED)
- One user LED (Green)
- Two 0.8mm pitch 100-pin board-to-board expansion connectors can carry out interfaces below
 - 2 x USB
 - 6 x Serial ports
 - 2 x I2C
 - 2 x CAN
 - 2 x SPI
 - 14 x ADC (8 channels from ADC1 and 6 channels from ADC0)
 - 3 x SDIO

Function Block Diagram

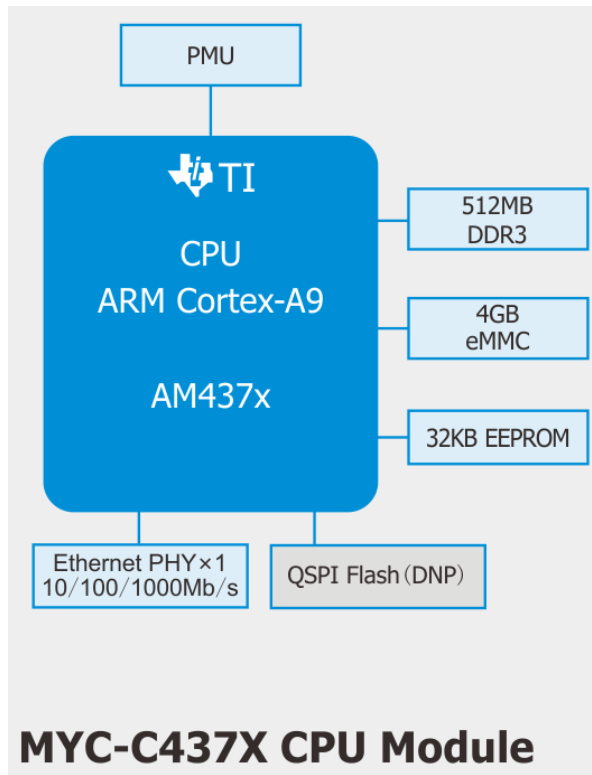

Figure 1-7 MYC-C437X Function Block Diagram

Dimension Chart of MYC-C437X

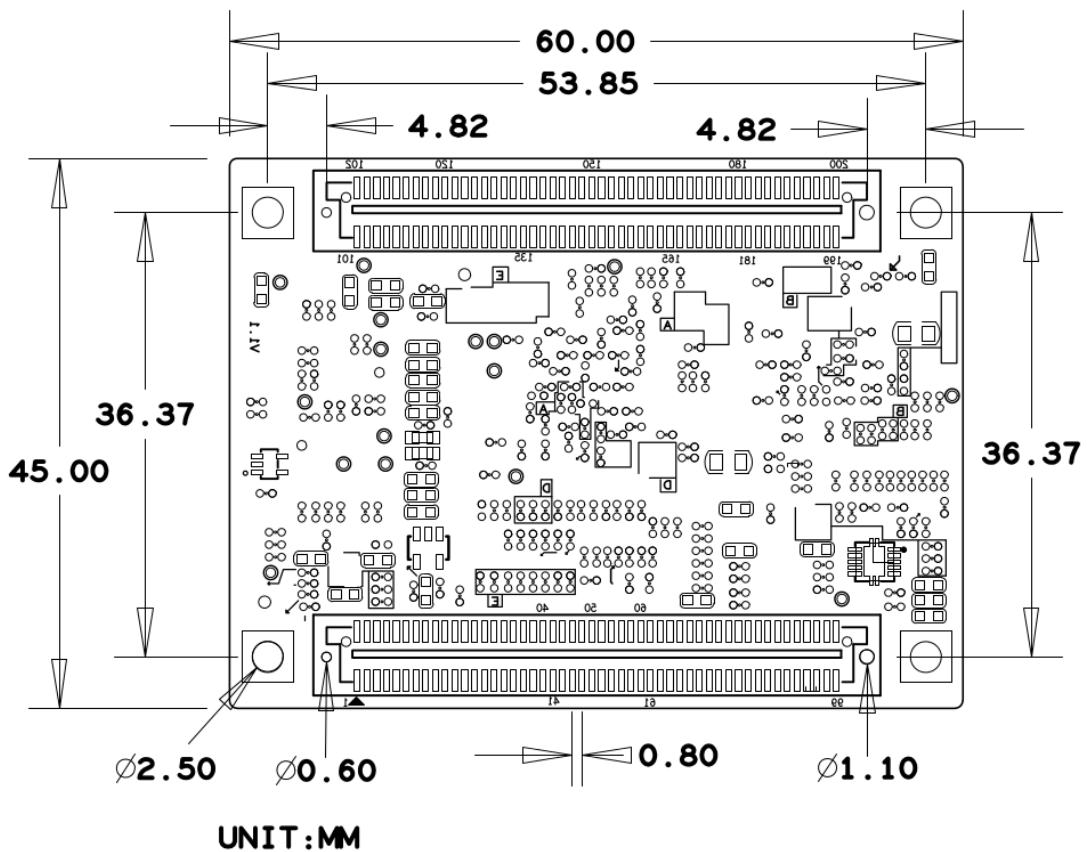

Figure 1-8 MYC-C437X Dimension Chart

Software Features

MYIR's MYC-C437X CPU module supports for Linux and is provided with software packages. Many peripheral drivers are in source code to help accelerate customers' designs with a stable and reliable hardware and software platform. The software features are summarized as below:

OS	Item	Features	Description
Linux	Bootstrap program	SPI	The primary bootstrap (source code)
		u-boot	The secondary bootstrap (source code)
	Kernel	Version	Linux 4.1.18 (source code)
	Drivers	USB Host	USB Host driver (source code)
		USB Device	USB Device driver (source code)
		Ethernet	Gigabit Ethernet driver (source code)
		MMC/SD/TF	MMC/SD/TF card driver (source code)
		NandFlash	Nand Flash driver (source code)
		eMMC	eMMC driver (source code)
		LCD Controller	LCD driver (source code, supports 7-inch LCD)
		RTC	RTC driver (source code)
		HDMI	HDMI driver (source code)
		Touch driver	Resistive and Capacitive touch screen driver (source code)
		Button	Button driver (source code)
		UART	UART driver (source code)
		LED	LED driver (source code)
		GPIO	GPIO driver (source code)
		Watchdog	Watchdog driver (source code)
		Camera	Camera driver (source code)
		CAN	CAN driver (source code)
ADC	ADC driver (source code)		
Audio	SGTL5000 driver (source code, do not provide at present)		
PWM	PWM driver (source code)		
File system	Buildroot	Provide tar package and ubi image file	

Table 1-1 Software Features of MYC-C437X

Order Information

Product Item	Packing List
MYC-C4378 CPU Module (Part No.: MYC-C4378-4E512D-100-C)	➤ One MYC-C437X CPU Module ➤ One Product DVD (including user manual, datasheet, and software packages)
MYC-C4378 CPU Module (Part No.: MYC-C4378-4E512D-100-I)	
MYC-C4377 CPU Module (Part No.: MYC-C4377-4E512D-100-I)	



MYIR Tech Limited

Room 04, 6th Floor, Building No.2, Fada Road, Yunli Smart Park,
Bantian, Longgang District, Shenzhen, Guangdong, China 518129

E-mail: sales@myirtech.com

Phone: +86-755-22984836

Fax: +86-755-25532724

Website: <http://www.myirtech.com>