

## OPAx211 1.1-nV/ $\sqrt{\text{Hz}}$ Noise, Low Power, Precision Operational Amplifiers

### 1 Features

- Low voltage noise: 1.1 nV/ $\sqrt{\text{Hz}}$  at 1 kHz
- Input voltage noise: 80 nV<sub>PP</sub> (0.1 to 10 Hz)
- THD + N: -136 dB (G = 1, f = 1 kHz)
- Offset voltage: 125  $\mu\text{V}$  (maximum)
- Offset voltage drift: 0.35  $\mu\text{V}/^\circ\text{C}$  (typical)
- Low supply current: 3.6 mA/Ch (typical)
- Unity-gain stable
- Gain bandwidth product:
  - 80 MHz (G = 100)
  - 45 MHz (G = 1)
- Slew rate: 27 V/ $\mu\text{s}$
- 16-Bit settling: 700 ns
- Wide supply range:
  - $\pm 2.25$  to  $\pm 18$  V, 4.5 V to 36 V
- Rail-to-rail output
- Output current: 30 mA
- SON-8 (3 mm  $\times$  3 mm), VSSOP-8, and SOIC-8

### 2 Applications

- [Ultrasound scanner](#)
- [Semiconductor test](#)
- [X-ray systems](#)
- [Lab and field instrumentation](#)
- [Data acquisition \(DAQ\)](#)
- [Radar](#)
- [Wireless communications test](#)
- [Seismic data acquisition](#)
- [DC power supply, ac source, electronic load](#)
- [Power analyzer](#)
- [Source measurement unit \(SMU\)](#)

### 3 Description

The OPAx211 series of precision operational amplifiers achieves very low 1.1-nV/ $\sqrt{\text{Hz}}$  noise density with a supply current of only 3.6 mA. This series also offers rail-to-rail output swing, which maximizes dynamic range.

The extremely low voltage and low current noise, high-speed, and wide output swing of the OPAx211 series make these devices an excellent choice as a loop filter amplifier in PLL applications.

In precision data acquisition applications, the OPAx211 series of operational amplifiers provides 700-ns settling time to 16-bit accuracy throughout 10-V output swings. This ac performance, combined with only 125  $\mu\text{V}$  of offset and 0.35  $\mu\text{V}/^\circ\text{C}$  of drift over temperature, makes the OPAx211 series a great choice for driving high-precision 16-bit analog-to-digital converters (ADCs) or buffering the output of high-resolution digital-to-analog converters (DACs).

The OPAx211 series is specified over a wide dual-power supply range of  $\pm 2.25$  to  $\pm 18$  V, or for single-supply operation from 4.5 to 36 V.

The OPA211 is available in the small SON-8 (3 mm  $\times$  3 mm), VSSOP-8, and SOIC-8 packages. The dual version OPA2211 is available in a SON-8 (3 mm  $\times$  3 mm) or an SO-8 PowerPAD™ package. This series of operational amplifiers is specified from T<sub>A</sub> = -40°C to +125°C.

#### Device Information<sup>(1)</sup>

PART NUMBER	PACKAGE	BODY SIZE (NOM)
OPA211	SOIC (8)	4.90 mm $\times$ 3.90 mm
	SON (8)	3.00 mm $\times$ 3.00 mm
	VSSOP (8)	3.00 mm $\times$ 3.00 mm
OPA2211	SON (8)	3.00 mm $\times$ 3.00 mm
	SO PowerPAD (8)	4.90 mm $\times$ 3.90 mm

(1) For all available packages, see the package option addendum at the end of the data sheet.

#### Input Voltage Noise Density vs Frequency

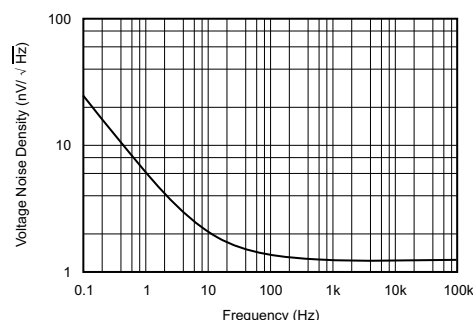

## Table of Contents

<b>1 Features</b> .....	<b>1</b>	7.4 Device Functional Modes.....	<b>21</b>
<b>2 Applications</b> .....	<b>1</b>	<b>8 Application and Implementation</b> .....	<b>22</b>
<b>3 Description</b> .....	<b>1</b>	8.1 Application Information.....	<b>22</b>
<b>4 Revision History</b> .....	<b>2</b>	8.2 Typical Application .....	<b>27</b>
<b>5 Pin Configuration and Functions</b> .....	<b>4</b>	<b>9 Power Supply Recommendations</b> .....	<b>28</b>
<b>6 Specifications</b> .....	<b>6</b>	<b>10 Layout</b> .....	<b>28</b>
6.1 Absolute Maximum Ratings .....	<b>6</b>	10.1 Layout Guidelines .....	<b>28</b>
6.2 ESD Ratings.....	<b>6</b>	10.2 Layout Example .....	<b>29</b>
6.3 Recommended Operating Conditions.....	<b>6</b>	<b>11 Device and Documentation Support</b> .....	<b>30</b>
6.4 Thermal Information: OPA211 and OPA211A .....	<b>7</b>	11.1 Device Support.....	<b>30</b>
6.5 Thermal Information: OPA2211 and OPA2211A .....	<b>7</b>	11.2 Documentation Support .....	<b>30</b>
6.6 Electrical Characteristics: Standard Grade OPAx211A .....	<b>8</b>	11.3 Related Links .....	<b>31</b>
6.7 Electrical Characteristics: High-Grade OPAx211.....	<b>10</b>	11.4 Receiving Notification of Documentation Updates	<b>31</b>
6.8 Typical Characteristics .....	<b>12</b>	11.5 Support Resources .....	<b>31</b>
<b>7 Detailed Description</b> .....	<b>19</b>	11.6 Trademarks .....	<b>31</b>
7.1 Overview .....	<b>19</b>	11.7 Electrostatic Discharge Caution.....	<b>31</b>
7.2 Functional Block Diagram .....	<b>19</b>	11.8 Glossary .....	<b>31</b>
7.3 Feature Description.....	<b>19</b>	<b>12 Mechanical, Packaging, and Orderable Information</b> .....	<b>31</b>

## 4 Revision History

NOTE: Page numbers for previous revisions may differ from page numbers in the current version.

<b>Changes from Revision K (September 2018) to Revision L</b>	<b>Page</b>
• Deleted NOM value from supply voltage in the <i>Recommended Operating Conditions</i> table .....	<b>6</b>
• Changed operating temperature to specified temperature in <i>Recommended Operating Conditions</i> table, and changed MIN and MAX from $-55^{\circ}\text{C}$ and $+150^{\circ}\text{C}$ to $-40^{\circ}\text{C}$ and $+125^{\circ}\text{C}$ , respectively .....	<b>6</b>
• Changed electrical characteristics table titles to clarify difference between standard and high-grade devices.....	<b>8</b>

<b>Changes from Revision J (February 2018) to Revision K</b>	<b>Page</b>
• Changed format of GPN from "OPA2x11" to "OPAx211" .....	<b>1</b>
• Corrected system-generated errors: "Time" units from "ms/div" back to " $\mu\text{s}/\text{div}$ " and unit for resistors from "W" back to " $\Omega$ " in <i>Typical Characteristics</i> .....	<b>12</b>
• Corrected system-generated error in unit for resistors from "W" back to " $\Omega$ " in <i>Figure 43</i> .....	<b>21</b>
• Reverted <i>Figure 51</i> back to that of rev. I .....	<b>29</b>

<b>Changes from Revision I (June 2016) to Revision J</b>	<b>Page</b>
• Changed product status from mixed product status to production data .....	<b>1</b>
• Deleted <i>Device Comparison</i> table .....	<b>4</b>
• Changed formatting of document reference in <i>EMI Rejection</i> section .....	<b>24</b>
• Changed formatting of document references in <i>SON Layout Guidelines</i> section.....	<b>29</b>
• Changed formatting of document references in <i>Related Documentation</i> section.....	<b>30</b>

<b>Changes from Revision H (November 2015) to Revision I</b>	<b>Page</b>
• Changed the SON pin number for V+ from 4 to 7 in the <i>Pin Functions: OPA211</i> table .....	<b>4</b>
• Changed the SON pin number for V- From: 7 To: 4 in the <i>Pin Functions: OPA211</i> table .....	<b>4</b>

---

**Changes from Revision G (May 2009) to Revision H****Page**

- 
- Added *ESD Ratings* table, *Feature Description* section, *Device Functional Modes*, *Application and Implementation* section, *Power Supply Recommendations* section, *Layout* section, *Device and Documentation Support* section, and *Mechanical, Packaging, and Orderable Information* section ..... 1
-

## 5 Pin Configuration and Functions

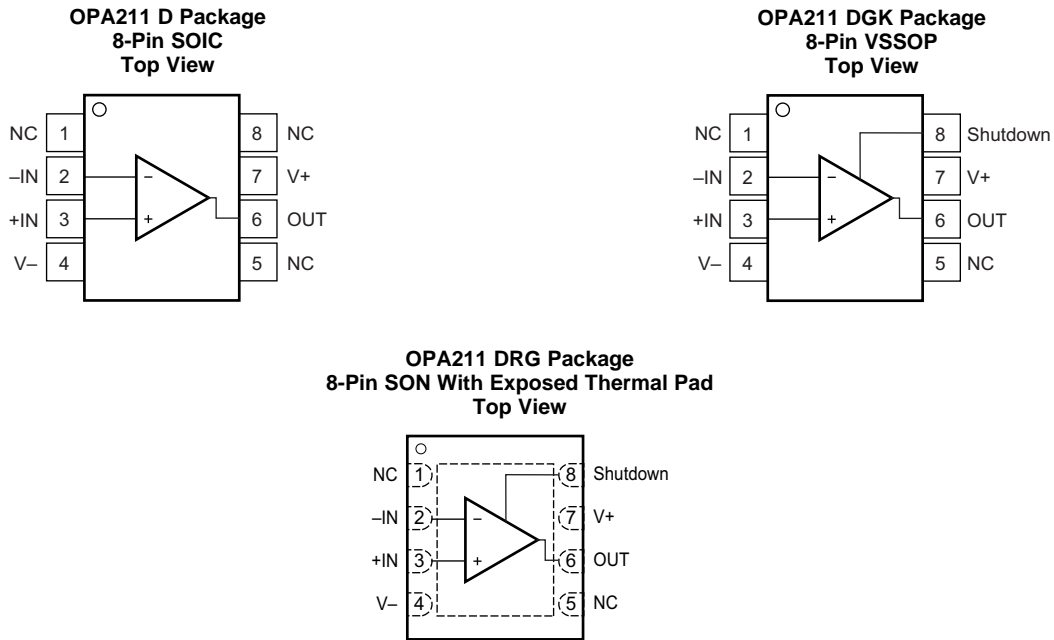

Pin Functions: OPA211

PIN		I/O	DESCRIPTION
NAME	NO.		
+IN	3	I	Noninverting input
-IN	2	I	Inverting input
NC	1, 5	—	No internal connection. This pin can be left floating or connected to any voltage between (V-) and (V+).
OUT	6	O	Output
Shutdown	8	I	Shutdown, active high The shutdown function is as follows: Device enabled: $(V-) \leq V_{SHUTDOWN} \leq (V+) - 3 V$ Device disabled: $V_{SHUTDOWN} \geq (V+) - 0.35 V$
V+	7	I	Positive power supply
V-	4	I	Negative power supply
Thermal pad	—	—	Exposed thermal die pad on underside; connect thermal die pad to V-. Soldering the thermal pad to the printed circuit board is required and improves heat dissipation and provides specified performance.

**OPA2211 DRG Package**  
8-Pin SON With Exposed Thermal Pad  
Top View

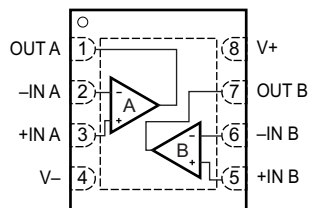

**OPA2211 DDA Package**  
8-Pin SO PowerPAD With Exposed Thermal Pad  
Top View

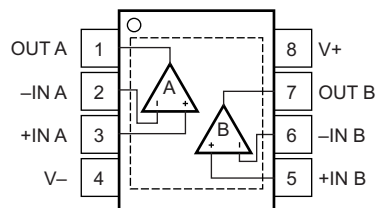

**Pin Functions: OPA2211**

PIN		I/O	DESCRIPTION
NAME	NO.		
+IN A	3	I	Noninverting input channel A
-IN A	2	I	Inverting input channel A
+IN B	5	I	Noninverting input channel B
-IN B	6	I	Inverting input channel B
OUT A	1	O	Output channel A
OUT B	7	O	Output channel B
V+	8	I	Positive power supply
V-	4	I	Negative power supply
Thermal pad	—	—	Exposed thermal die pad on underside; connect thermal die pad to V-. Soldering the thermal pad improves heat dissipation and provides specified performance.

## 6 Specifications

### 6.1 Absolute Maximum Ratings

over operating free-air temperature (unless otherwise noted)<sup>(1)</sup>

		MIN	MAX	UNIT
$V_S$	Supply voltage, $V_S = (V+) - (V-)$		40	V
	Input voltage	$(V-) - 0.5$	$(V+) + 0.5$	V
	Input current (any pin except power-supply pins)		$\pm 10$	mA
	Output short-circuit <sup>(2)</sup>	Continuous		
$T_A$	Operating temperature	-55	150	°C
$T_J$	Junction temperature		200	°C
$T_{stg}$	Storage temperature	-65	150	°C

- (1) Stresses beyond those listed under *Absolute Maximum Ratings* may cause permanent damage to the device. These are stress ratings only, which do not imply functional operation of the device at these or any other conditions beyond those indicated under *Recommended Operating Conditions*. Exposure to absolute-maximum-rated conditions for extended periods may affect device reliability.
- (2) Short-circuit to  $V_S / 2$  (ground in symmetrical dual-supply setups), one amplifier per package.

### 6.2 ESD Ratings

			VALUE	UNIT
$V_{(ESD)}$	Electrostatic discharge	Human body model (HBM), per ANSI/ESDA/JEDEC JS-001, all pins <sup>(1)</sup>	3000	V
		Charged-device model (CDM), per JEDEC specification JESD22-C101, all pins <sup>(2)</sup>	1000	V

- (1) JEDEC document JEP155 states that 500-V HBM allows safe manufacturing with a standard ESD control process.
- (2) JEDEC document JEP157 states that 250-V CDM allows safe manufacturing with a standard ESD control process.

### 6.3 Recommended Operating Conditions

over operating free-air temperature range (unless otherwise noted)

		MIN	NOM	MAX	UNIT
$V_S$	Supply voltage, $V_S = (V+) - (V-)$	4.5 ( $\pm 2.25$ )		36 ( $\pm 18$ )	V
$T_A$	Specified temperature	-40	25	125	°C

#### 6.4 Thermal Information: OPA211 and OPA211A

THERMAL METRIC <sup>(1)</sup>		OPA211, OPA211A			UNIT
		D (SOIC)	DRG (SON)	DGK (VSSOP)	
		8 PINS	8 PINS	8 PINS	
$R_{\theta JA}$	Junction-to-ambient thermal resistance, high-K board	122.2	125	184.9	°C/W
$R_{\theta JC(top)}$	Junction-to-case (top) thermal resistance	62.5	N/A	71.2	°C/W
$R_{\theta JB}$	Junction-to-board thermal resistance	64.3	28.8	104.9	°C/W
$\Psi_{JT}$	Junction-to-top characterization parameter	14.2	3	11.5	°C/W
$\Psi_{JB}$	Junction-to-board characterization parameter	63.6	25	103.4	°C/W
$R_{\theta JC(bot)}$	Junction-to-case (bottom) thermal resistance	N/A	19.1	N/A	°C/W

(1) For more information about traditional and new thermal metrics, see the [Semiconductor and IC Package Thermal Metrics application report](#).

#### 6.5 Thermal Information: OPA2211 and OPA2211A

THERMAL METRIC <sup>(1)</sup>		OPA2211, OPA2211A		UNIT
		DDA (SO-PowerPAD)	DRG (SON)	
		8 PINS	8 PINS	
$R_{\theta JA}$	Junction-to-ambient thermal resistance, high-K board	50.4	125	°C/W
$R_{\theta JC(top)}$	Junction-to-case (top) thermal resistance	N/A	N/A	°C/W
$R_{\theta JB}$	Junction-to-board thermal resistance	13	28.8	°C/W
$\Psi_{JT}$	Junction-to-top characterization parameter	5.2	3	°C/W
$\Psi_{JB}$	Junction-to-board characterization parameter	11.7	25	°C/W
$R_{\theta JC(bot)}$	Junction-to-case (bottom) thermal resistance	1.1	19.1	°C/W

(1) For more information about traditional and new thermal metrics, see the [Semiconductor and IC Package Thermal Metrics application report](#).

## 6.6 Electrical Characteristics: Standard Grade OPAx211A

 at  $T_A = 25^\circ\text{C}$ ,  $V_S = \pm 2.25$  to  $\pm 18$  V,  $R_L = 10$  k $\Omega$  connected to midsupply, and  $V_{CM} = V_{OUT} =$  midsupply (unless otherwise noted)

PARAMETER		TEST CONDITIONS		MIN	TYP	MAX	UNIT	
<b>OFFSET VOLTAGE</b>								
$V_{OS}$	Input offset voltage	$V_S = \pm 15$ V	OPA211A		$\pm 30$	$\pm 125$	$\mu\text{V}$	
			OPA2211A		$\pm 50$	$\pm 150$		
$dV_{OS}/dT$	Input offset drift	$V_S = \pm 15$ V, $T_A = -40^\circ\text{C}$ to $+125^\circ\text{C}$			$\pm 0.35$	$\pm 1.5$	$\mu\text{V}/^\circ\text{C}$	
PSRR	Input offset voltage vs power supply	$T_A = 25^\circ\text{C}$			0.1	1	$\mu\text{V}/\text{V}$	
		$T_A = -40^\circ\text{C}$ to $+125^\circ\text{C}$				3		
<b>INPUT BIAS CURRENT</b>								
$I_B$	Input bias current	$V_{CM} = 0$ V			$\pm 60$	$\pm 175$	nA	
		$V_{CM} = 0$ V, $T_A = -40^\circ\text{C}$ to $+125^\circ\text{C}$	OPA211A					$\pm 200$
			OPA2211A					$\pm 250$
$I_{OS}$	Input offset current	$V_{CM} = 0$ V			$\pm 25$	$\pm 100$	nA	
		$V_{CM} = 0$ V, $T_A = -40^\circ\text{C}$ to $+125^\circ\text{C}$						$\pm 150$
<b>NOISE</b>								
$e_n$	Input voltage noise	$f = 0.1$ to $10$ Hz			80		$\text{nV}_{PP}$	
	Input voltage noise density	$f = 10$ Hz			2		$\text{nV}/\sqrt{\text{Hz}}$	
		$f = 100$ Hz			1.4			
		$f = 1$ kHz			1.1			
$I_n$	Input current noise density	$f = 10$ Hz			3.2		$\text{pA}/\sqrt{\text{Hz}}$	
		$f = 1$ kHz			1.7			
<b>INPUT VOLTAGE</b>								
$V_{CM}$	Common-mode voltage range	$V_S \geq \pm 5$ V		$(V-) + 1.8$		$(V+) - 1.4$	V	
		$V_S < \pm 5$ V		$(V-) + 2$		$(V+) - 1.4$		
CMRR	Common-mode rejection ratio	$V_S \geq \pm 5$ V, $(V-) + 2$ V $\leq V_{CM} \leq (V+) - 2$ V, $T_A = -40^\circ\text{C}$ to $+125^\circ\text{C}$		114	120		dB	
		$V_S < \pm 5$ V, $(V-) + 2$ V $\leq V_{CM} \leq (V+) - 2$ V, $T_A = -40^\circ\text{C}$ to $+125^\circ\text{C}$		110	120			
<b>INPUT IMPEDANCE</b>								
	Differential				20    8		k $\Omega$    pF	
	Common-mode				10    2		G $\Omega$    pF	
<b>OPEN-LOOP GAIN</b>								
$A_{OL}$	Open-loop voltage gain	$(V-) + 0.2$ V $\leq V_O \leq (V+) - 0.2$ V, $R_L = 10$ k $\Omega$ , $T_A = -40^\circ\text{C}$ to $+125^\circ\text{C}$		114	130		dB	
		$(V-) + 0.6$ V $\leq V_O \leq (V+) - 0.6$ V, $R_L = 600$ $\Omega$		110	114			
		OPA211A: $(V-) + 0.6$ V $\leq V_O \leq (V+) - 0.6$ V, $I_O \leq 15$ mA, $T_A = -40^\circ\text{C}$ to $+125^\circ\text{C}$		110				
		OPA211A: $(V-) + 0.6$ V $\leq V_O \leq (V+) - 0.6$ V, $15$ mA $< I_O \leq 30$ mA, $T_A = -40^\circ\text{C}$ to $+125^\circ\text{C}$		103				
		OPA2211A: $(V-) + 0.6$ V $\leq V_O \leq (V+) - 0.6$ V, $I_O \leq 15$ mA, $T_A = -40^\circ\text{C}$ to $+125^\circ\text{C}$		100				



**Electrical Characteristics: Standard Grade OPAx211A (continued)**

at  $T_A = 25^\circ\text{C}$ ,  $V_S = \pm 2.25$  to  $\pm 18$  V,  $R_L = 10$  k $\Omega$  connected to midsupply, and  $V_{CM} = V_{OUT} =$  midsupply (unless otherwise noted)

PARAMETER		TEST CONDITIONS		MIN	TYP	MAX	UNIT
<b>FREQUENCY RESPONSE</b>							
GBW	Gain-bandwidth product	G = 100		80			MHz
		G = 1		45			
SR	Slew rate			27			V/ $\mu$ s
$t_S$	Settling time	$V_S = \pm 15$ V, G = -1, 10-V step, $C_L = 100$ pF	0.01%	400			ns
			0.0015% (16-bit)	700			
	Overload recovery time	G = -10		500			ns
THD+N	Total harmonic distortion + noise	G = 1, f = 1 kHz, $V_O = 3 V_{RMS}$ , $R_L = 600 \Omega$		0.000015%			dB
				-136			
<b>OUTPUT</b>							
$V_{OUT}$	Voltage output	$R_L = 10$ k $\Omega$ , $A_{OL} \geq 114$ dB, $T_A = -40^\circ\text{C}$ to $+125^\circ\text{C}$		(V-) + 0.2	(V+) - 0.2		V
		$R_L = 600 \Omega$ , $A_{OL} \geq 110$ dB		(V-) + 0.6	(V+) - 0.6		
		$I_O < 15$ mA, $A_{OL} \geq 110$ dB, $T_A = -40^\circ\text{C}$ to $+125^\circ\text{C}$		(V-) + 0.6	(V+) - 0.6		
$I_{SC}$	Short-circuit current			+30/-45			mA
$C_{LOAD}$	Capacitive load drive			See <a href="#">Typical Characteristics</a>			pF
$Z_O$	Open-loop output impedance	f = 1 MHz		5			$\Omega$
<b>SHUTDOWN</b>							
$V_{Shutdown}$	Shutdown pin input voltage <sup>(1)</sup>	Device disabled (shutdown)		(V+) - 0.35			V
		Device enabled		(V+) - 3			
	Shutdown pin leakage current			1			$\mu$ A
	Turn-on time <sup>(2)</sup>			2			$\mu$ s
	Turn-off time <sup>(2)</sup>			3			$\mu$ s
	Shutdown current	Shutdown (disabled)		1		20	$\mu$ A
<b>POWER SUPPLY</b>							
$I_Q$	Quiescent current (per channel)	$I_{OUT} = 0$ A		3.6		4.5	mA
		$I_{OUT} = 0$ A, $T_A = -40^\circ\text{C}$ to $+125^\circ\text{C}$				6	

(1) When disabled, the output assumes a high-impedance state.

(2) See [Typical Characteristics](#) curves ([Figure 39](#) through [Figure 41](#)).

## 6.7 Electrical Characteristics: High-Grade OPAX211

 at  $T_A = 25^\circ\text{C}$ ,  $V_S = \pm 2.25$  to  $\pm 18$  V,  $R_L = 10$  k $\Omega$  connected to midsupply, and  $V_{CM} = V_{OUT} =$  midsupply (unless otherwise noted)

PARAMETER		TEST CONDITIONS	MIN	TYP	MAX	UNIT
<b>OFFSET VOLTAGE</b>						
$V_{OS}$	Input offset voltage	$V_S = \pm 15$ V		$\pm 20$	$\pm 50$	$\mu\text{V}$
$dV_{OS}/dT$	Input offset drift	$V_S = \pm 15$ V, $T_A = -40^\circ\text{C}$ to $+125^\circ\text{C}$		$\pm 0.15$	$\pm 0.85$	$\mu\text{V}/^\circ\text{C}$
PSRR	Input offset voltage vs power supply	$T_A = 25^\circ\text{C}$		0.1	0.5	$\mu\text{V}/\text{V}$
		$T_A = -40^\circ\text{C}$ to $+125^\circ\text{C}$			3	
<b>INPUT BIAS CURRENT</b>						
$I_B$	Input bias current	$V_{CM} = 0$ V		$\pm 50$	$\pm 125$	nA
		$V_{CM} = 0$ V, $T_A = -40^\circ\text{C}$ to $+125^\circ\text{C}$			$\pm 200$	
$I_{OS}$	Input offset current	$V_{CM} = 0$ V		$\pm 20$	$\pm 75$	nA
		$T_A = -40^\circ\text{C}$ to $+125^\circ\text{C}$			$\pm 150$	
<b>NOISE</b>						
$e_n$	Input voltage noise	$f = 0.1$ to $10$ Hz		80		nV <sub>pp</sub>
	Input voltage noise density	$f = 10$ Hz		2		nV/ $\sqrt{\text{Hz}}$
		$f = 100$ Hz		1.4		
		$f = 1$ kHz		1.1		
$I_n$	Input current noise density	$f = 10$ Hz		3.2		pA/ $\sqrt{\text{Hz}}$
		$f = 1$ kHz		1.7		
<b>INPUT VOLTAGE</b>						
$V_{CM}$	Common-mode voltage range	$V_S \geq \pm 5$ V	$(V-) + 1.8$		$(V+) - 1.4$	V
		$V_S < \pm 5$ V	$(V-) + 2$		$(V+) - 1.4$	
CMRR	Common-mode rejection ratio	$V_S \geq \pm 5$ V, $(V-) + 2$ V $\leq V_{CM} \leq (V+) - 2$ V, $T_A = -40^\circ\text{C}$ to $+125^\circ\text{C}$	114	120		dB
		$V_S < \pm 5$ V, $(V-) + 2$ V $\leq V_{CM} \leq (V+) - 2$ V, $T_A = -40^\circ\text{C}$ to $+125^\circ\text{C}$	110	120		
<b>INPUT IMPEDANCE</b>						
	Differential			20    8		k $\Omega$    pF
	Common-mode			10    2		G $\Omega$    pF
<b>OPEN-LOOP GAIN</b>						
$A_{OL}$	Open-loop voltage gain	$(V-) + 0.2$ V $\leq V_O \leq (V+) - 0.2$ V, $R_L = 10$ k $\Omega$ , $T_A = -40^\circ\text{C}$ to $+125^\circ\text{C}$ ,	114	130		dB
		$(V-) + 0.6$ V $\leq V_O \leq (V+) - 0.6$ V, $R_L = 600$ $\Omega$	110	114		
		OPA211: $(V-) + 0.6$ V $\leq V_O \leq (V+) - 0.6$ V, $I_O \leq 15$ mA, $T_A = -40^\circ\text{C}$ to $+125^\circ\text{C}$	110			
		OPA211: $(V-) + 0.6$ V $\leq V_O \leq (V+) - 0.6$ V, $15$ mA $< I_O \leq 30$ mA, $T_A = -40^\circ\text{C}$ to $+125^\circ\text{C}$	103			

**Electrical Characteristics: High-Grade OPAx211 (continued)**

at  $T_A = 25^\circ\text{C}$ ,  $V_S = \pm 2.25$  to  $\pm 18$  V,  $R_L = 10$  k $\Omega$  connected to midsupply, and  $V_{CM} = V_{OUT} =$  midsupply (unless otherwise noted)

PARAMETER		TEST CONDITIONS		MIN	TYP	MAX	UNIT
<b>FREQUENCY RESPONSE</b>							
GBW	Gain-bandwidth product	G = 100		80			MHz
		G = 1		45			
SR	Slew rate			27			V/ $\mu$ s
$t_S$	Settling time	$V_S = \pm 15$ V, G = -1, 10-V step, $C_L = 100$ pF	0.01%	400			ns
			0.0015% (16-bit)	700			ns
	Overload recovery time	G = -10		500			ns
THD+N	Total harmonic distortion + noise	G = 1, f = 1 kHz, $V_O = 3 V_{RMS}$ , $R_L = 600 \Omega$		0.000015%			
				-136			dB
<b>OUTPUT</b>							
$V_{OUT}$	Voltage output	$R_L = 10$ k $\Omega$ , $A_{OL} \geq 114$ dB, $T_A = -40^\circ\text{C}$ to $+125^\circ\text{C}$		(V-) + 0.2	(V+) - 0.2		V
		$R_L = 600 \Omega$ , $A_{OL} \geq 110$ dB		(V-) + 0.6	(V+) - 0.6		
		$I_O < 15$ mA, $A_{OL} \geq 110$ dB, $T_A = -40^\circ\text{C}$ to $+125^\circ\text{C}$		(V-) + 0.6	(V+) - 0.6		
$I_{SC}$	Short-circuit current			+30 / -45			mA
$C_{LOAD}$	Capacitive load drive			See <a href="#">Typical Characteristics</a>			pF
$Z_O$	Open-loop output impedance	f = 1 MHz		5			$\Omega$
<b>SHUTDOWN</b>							
$V_{Shutdown}$	Shutdown pin input voltage <sup>(1)</sup>	Device disabled (shutdown)		(V+) - 0.35			V
		Device enabled		(V+) - 3			
	Shutdown pin leakage current			1			$\mu$ A
	Turn-on time <sup>(2)</sup>			2			$\mu$ s
	Turn-off time <sup>(2)</sup>			3			$\mu$ s
	Shutdown current	Shutdown (disabled)		1		20	$\mu$ A
<b>POWER SUPPLY</b>							
$I_Q$	Quiescent current (per channel)	$I_{OUT} = 0$ A		3.6		4.5	mA
		$I_{OUT} = 0$ A, $T_A = -40^\circ\text{C}$ to $+125^\circ\text{C}$				6	

(1) When disabled, the output assumes a high-impedance state.

(2) See [Typical Characteristics](#) curves ([Figure 39](#) through [Figure 41](#)).

### 6.8 Typical Characteristics

at  $T_A = 25^\circ\text{C}$ ,  $V_S = \pm 18\text{ V}$ , and  $R_L = 10\text{ k}\Omega$ , unless otherwise noted.

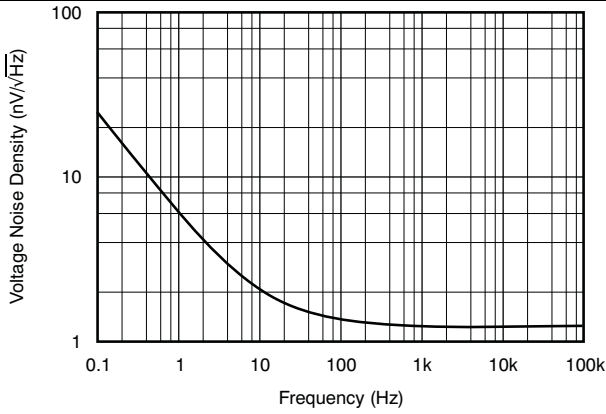

Figure 1. Input Voltage Noise Density vs Frequency

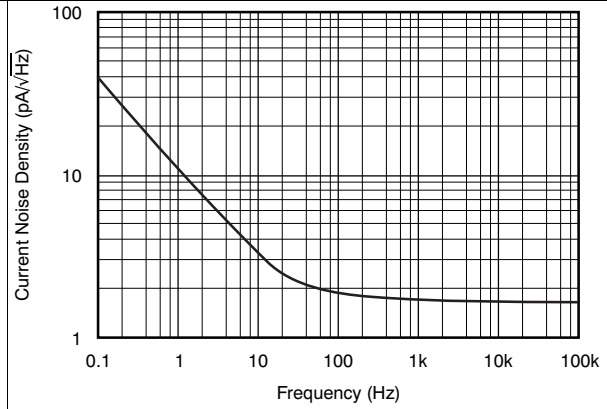

Figure 2. Input Current Noise Density vs Frequency

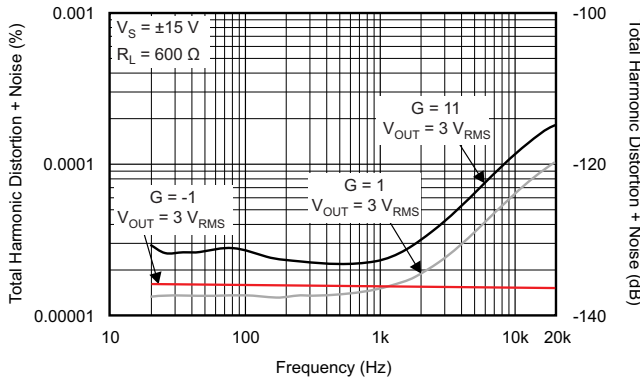

Figure 3. THD + N Ratio vs Frequency

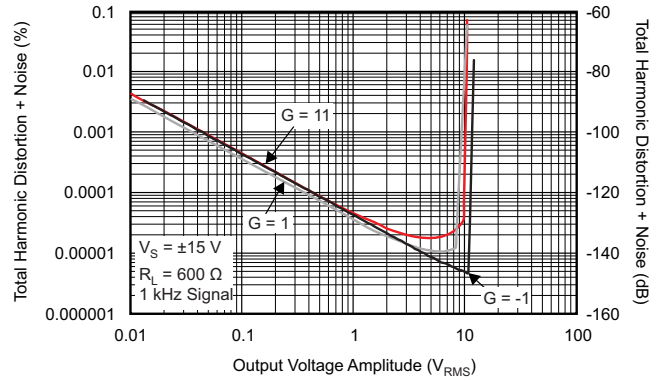

Figure 4. THD + N Ratio vs Output Voltage Amplitude

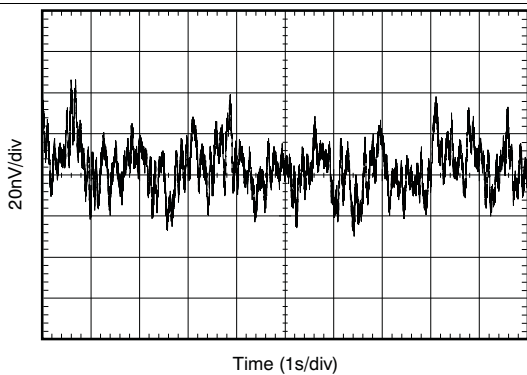

Figure 5. 0.1- to 10-Hz Noise

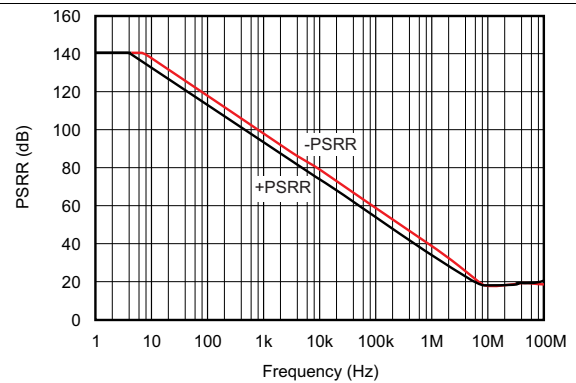

Figure 6. Power-Supply Rejection Ratio vs Frequency (Referred to Input)

### Typical Characteristics (continued)

at  $T_A = 25^\circ\text{C}$ ,  $V_S = \pm 18\text{ V}$ , and  $R_L = 10\text{ k}\Omega$ , unless otherwise noted.

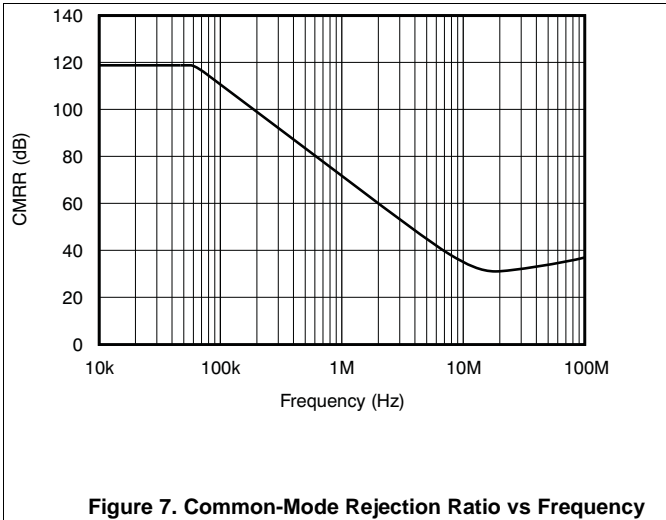

Figure 7. Common-Mode Rejection Ratio vs Frequency

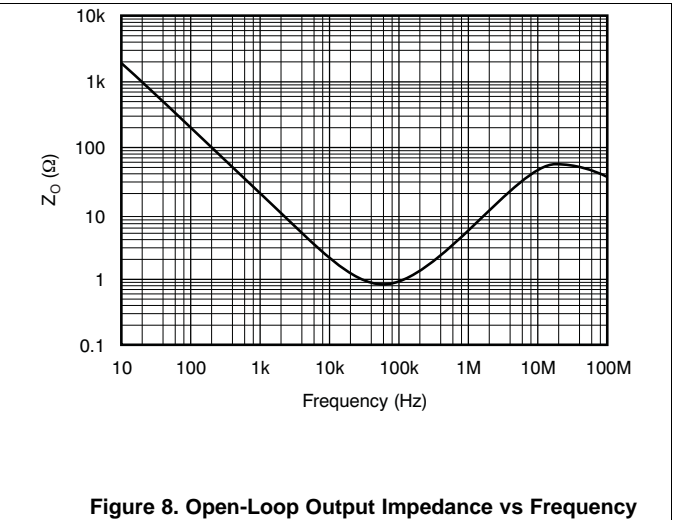

Figure 8. Open-Loop Output Impedance vs Frequency

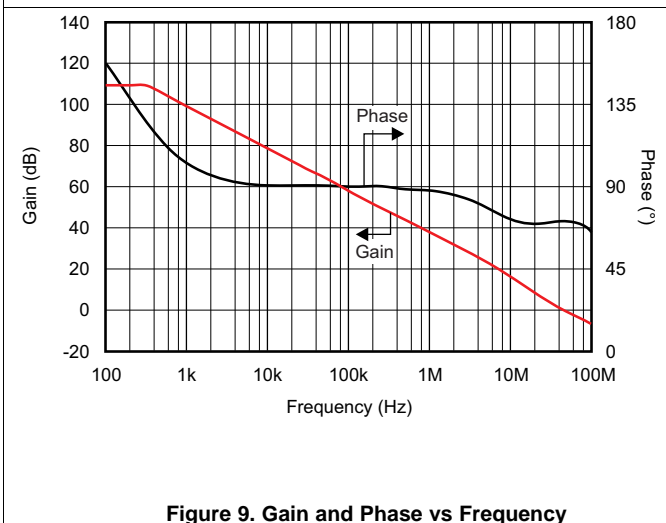

Figure 9. Gain and Phase vs Frequency

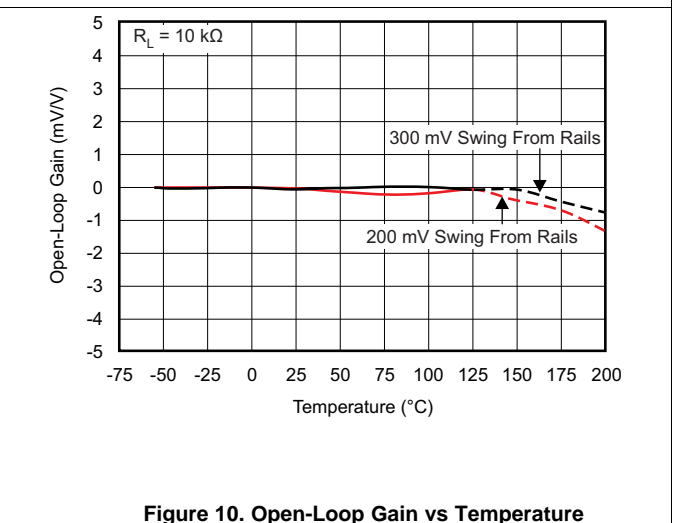

Figure 10. Open-Loop Gain vs Temperature

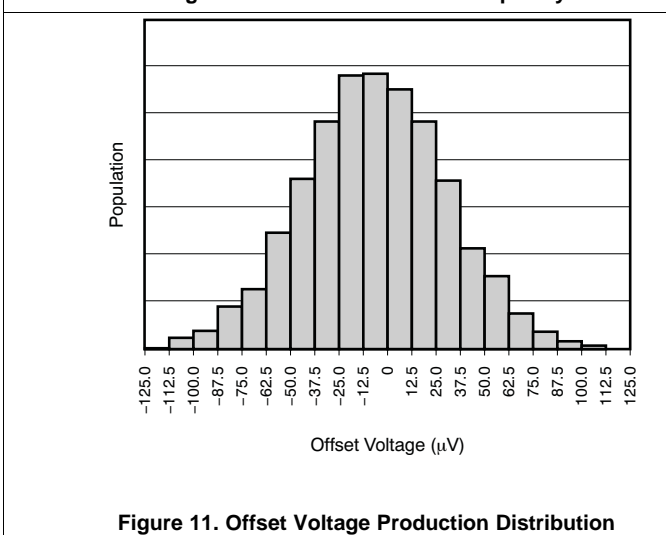

Figure 11. Offset Voltage Production Distribution

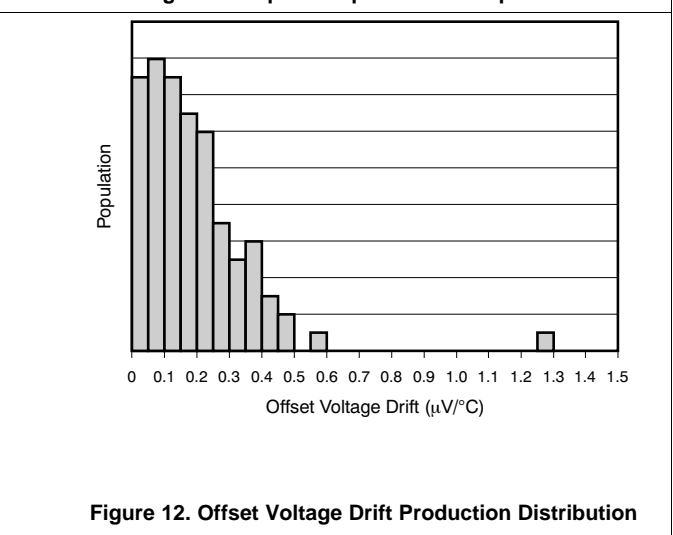

Figure 12. Offset Voltage Drift Production Distribution

### Typical Characteristics (continued)

at  $T_A = 25^\circ\text{C}$ ,  $V_S = \pm 18\text{ V}$ , and  $R_L = 10\text{ k}\Omega$ , unless otherwise noted.

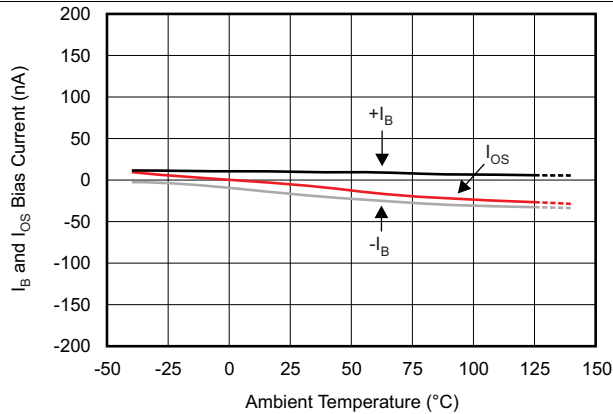

Figure 13.  $I_B$  and  $I_{OS}$  Current vs Temperature

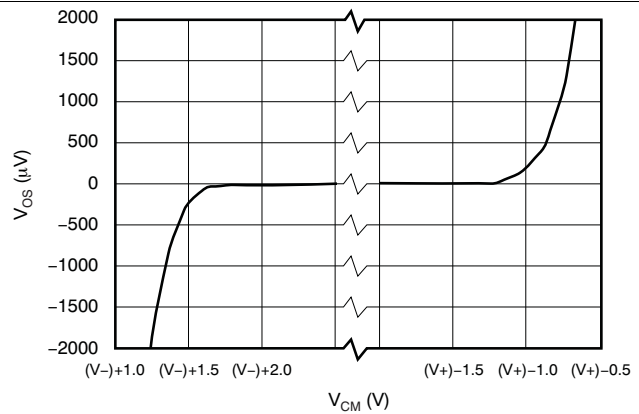

Figure 14. Offset Voltage vs Common-Mode Voltage

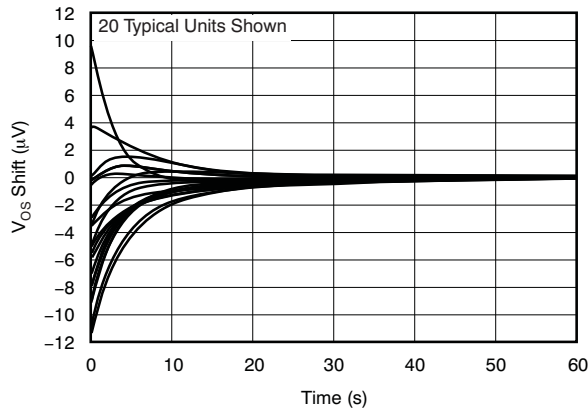

Figure 15.  $V_{OS}$  Warm-Up

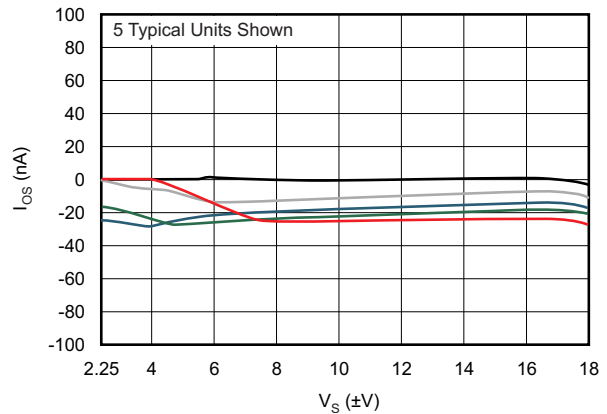

Figure 16. Input Offset Current vs Supply Voltage

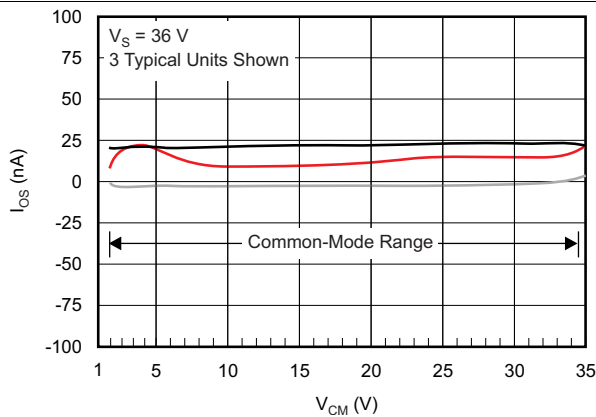

Figure 17. Input Offset Current vs Common-Mode Voltage

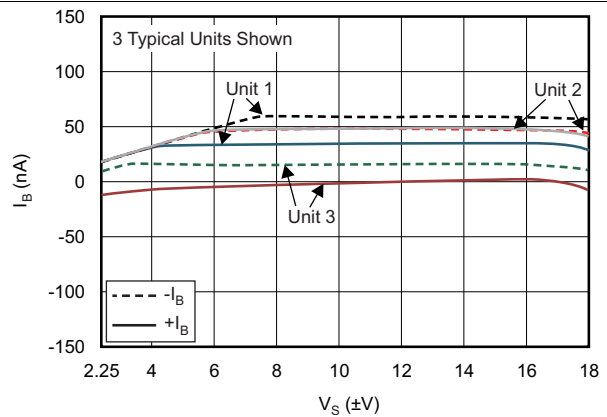

Figure 18. Input Bias Current vs Supply Voltage

Typical Characteristics (continued)

at  $T_A = 25^\circ\text{C}$ ,  $V_S = \pm 18\text{ V}$ , and  $R_L = 10\text{ k}\Omega$ , unless otherwise noted.

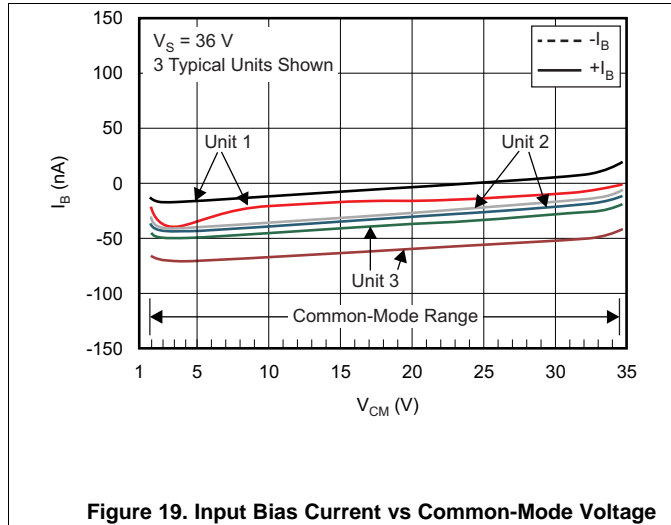

Figure 19. Input Bias Current vs Common-Mode Voltage

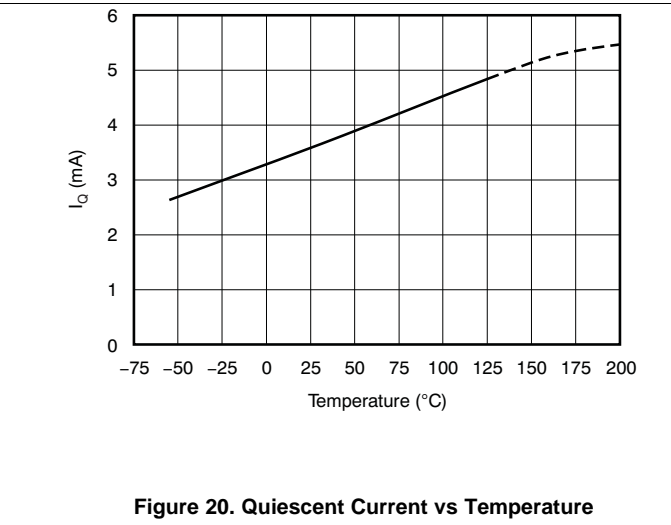

Figure 20. Quiescent Current vs Temperature

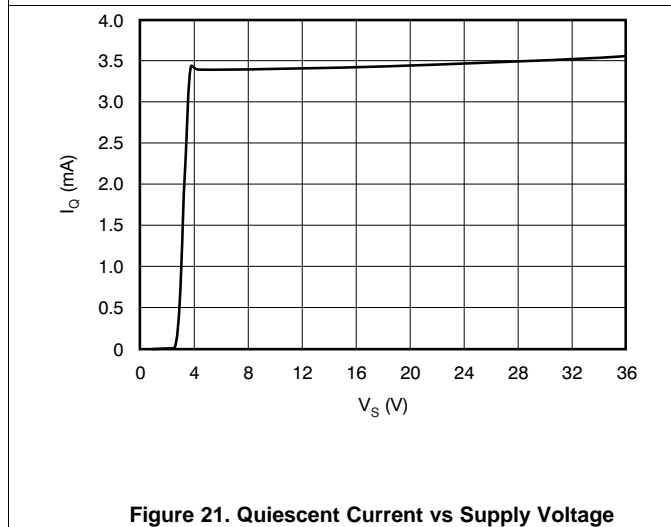

Figure 21. Quiescent Current vs Supply Voltage

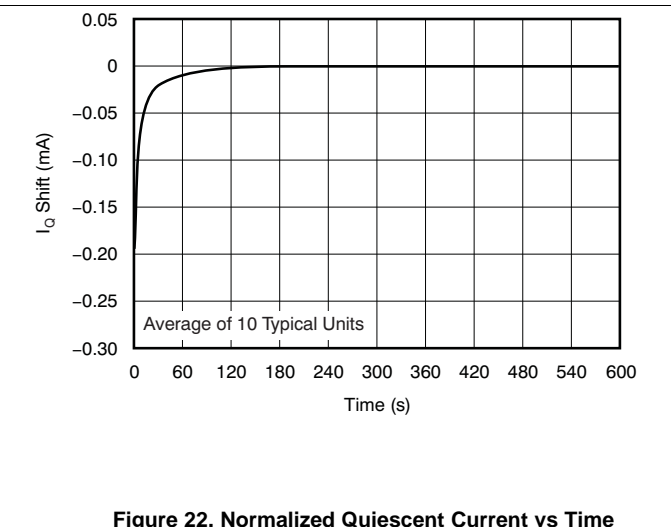

Figure 22. Normalized Quiescent Current vs Time

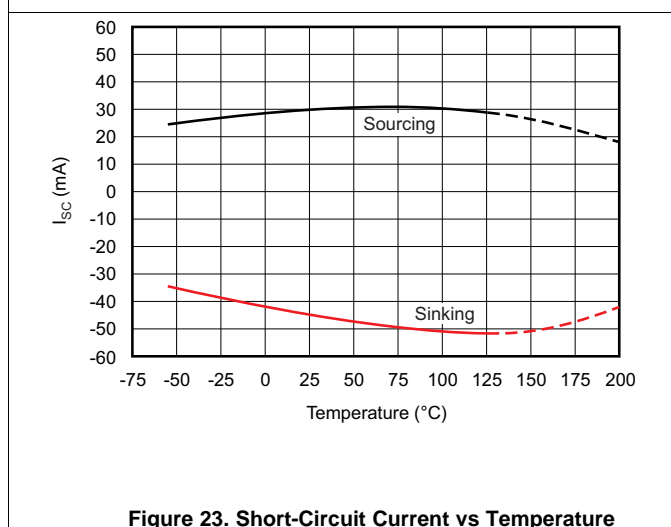

Figure 23. Short-Circuit Current vs Temperature

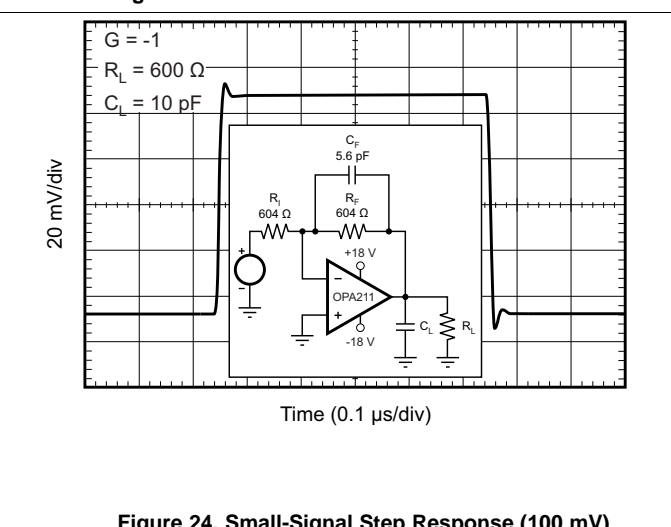

Figure 24. Small-Signal Step Response (100 mV)

Typical Characteristics (continued)

at  $T_A = 25^\circ\text{C}$ ,  $V_S = \pm 18\text{ V}$ , and  $R_L = 10\text{ k}\Omega$ , unless otherwise noted.

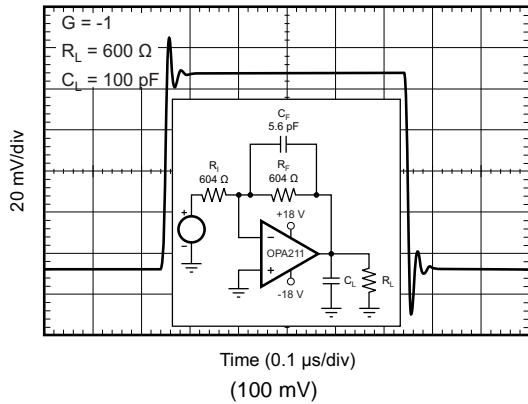

Figure 25. Small-Signal Step Response

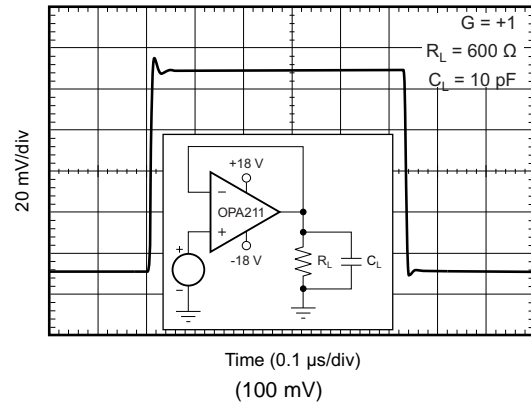

Figure 26. Small-Signal Step Response

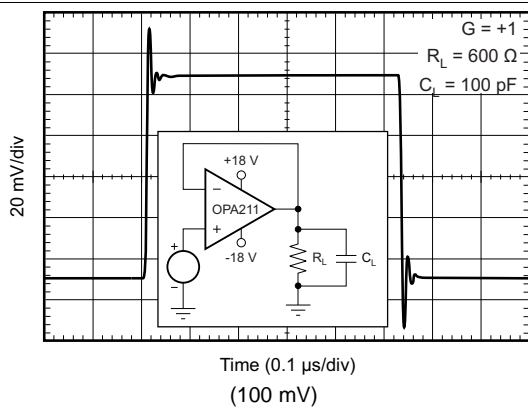

Figure 27. Small-Signal Step Response

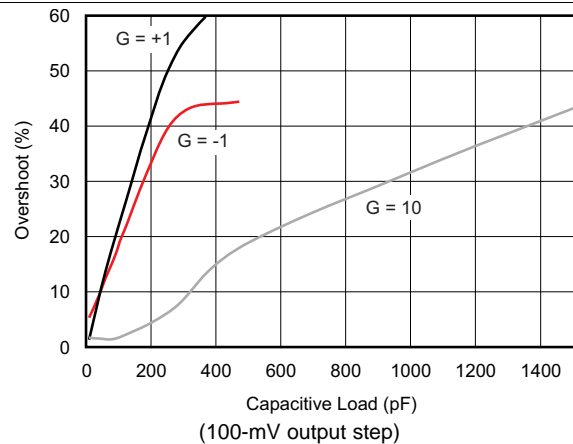

Figure 28. Small-Signal Overshoot vs Capacitive Load

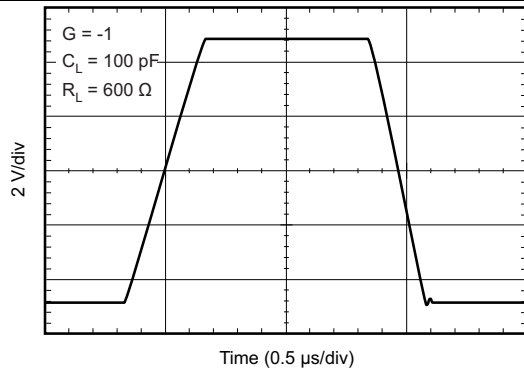

Figure 29. Large-Signal Step Response

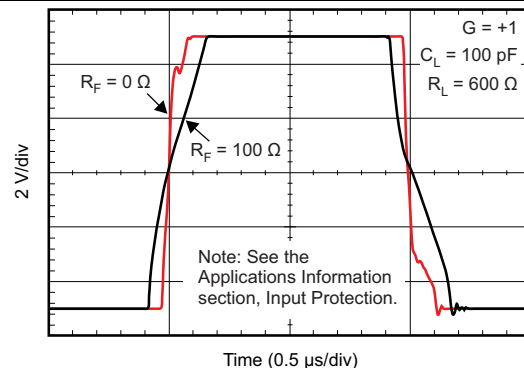
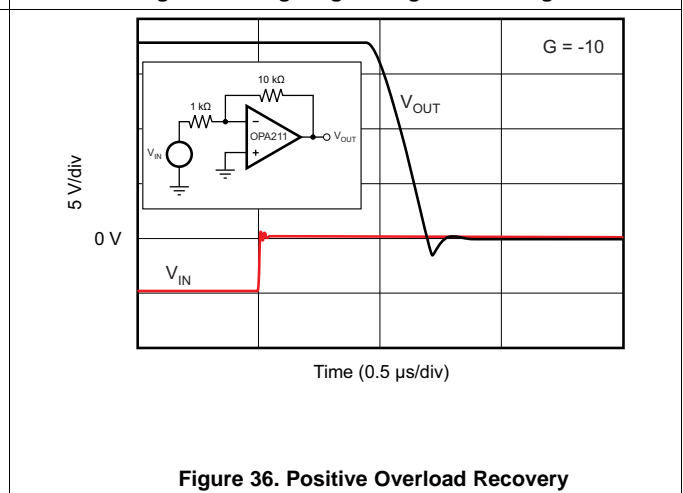
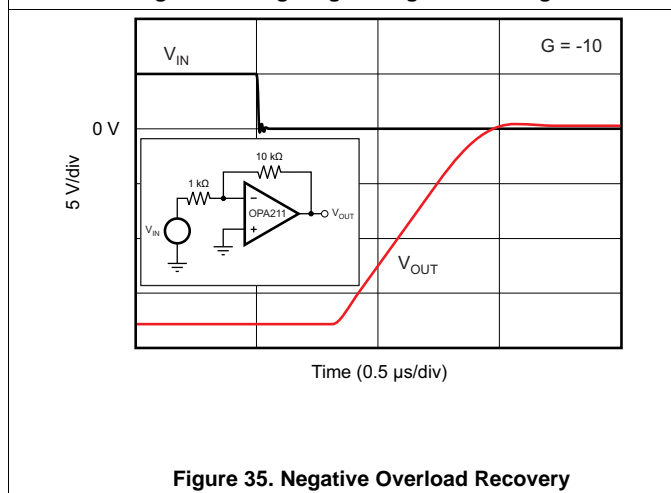
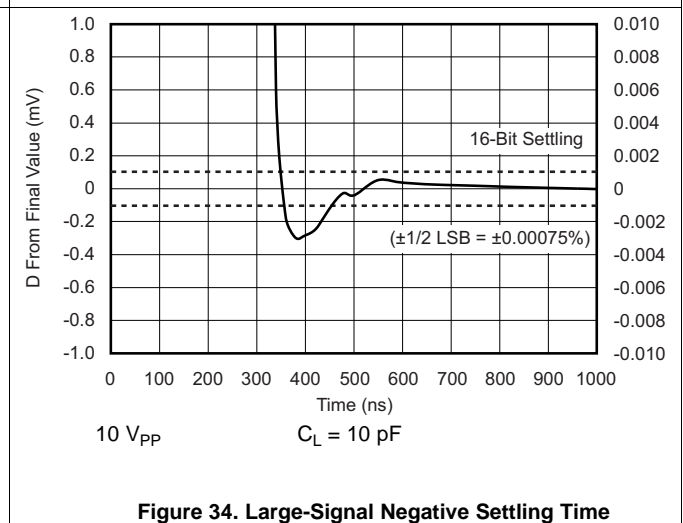
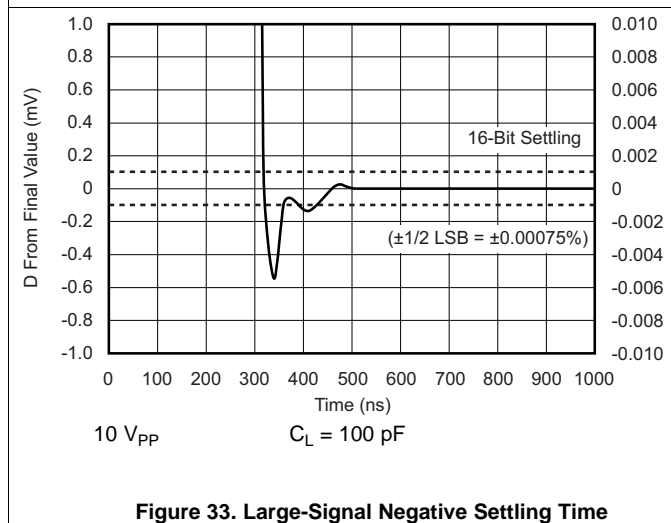
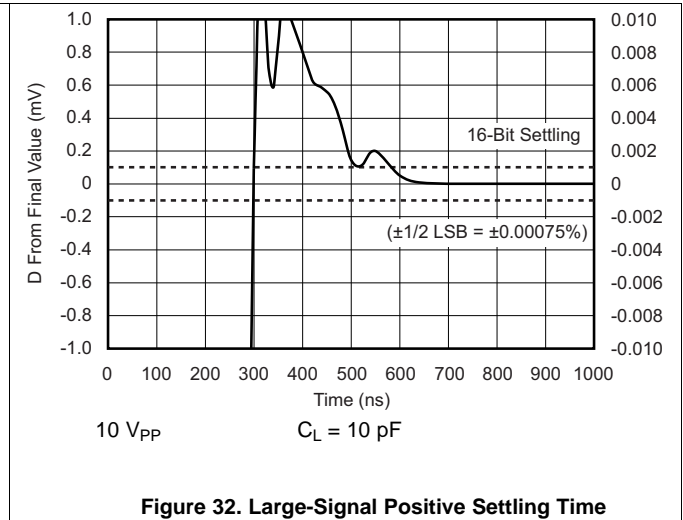
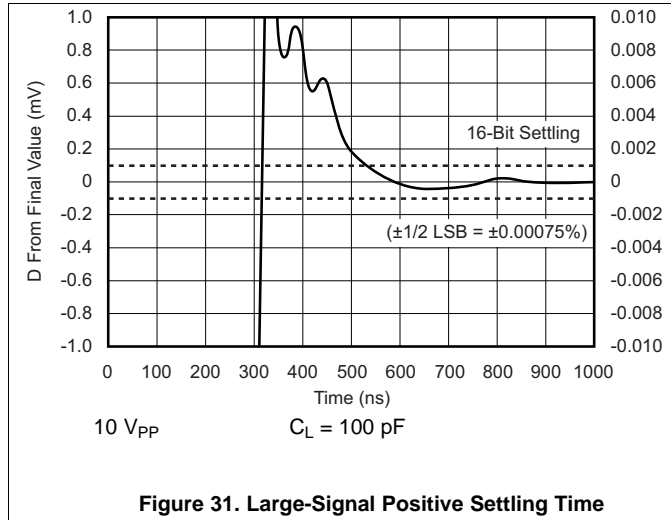

Figure 30. Large-Signal Step Response



Typical Characteristics (continued)

at  $T_A = 25^\circ\text{C}$ ,  $V_S = \pm 18\text{ V}$ , and  $R_L = 10\text{ k}\Omega$ , unless otherwise noted.



### Typical Characteristics (continued)

at  $T_A = 25^\circ\text{C}$ ,  $V_S = \pm 18\text{ V}$ , and  $R_L = 10\text{ k}\Omega$ , unless otherwise noted.

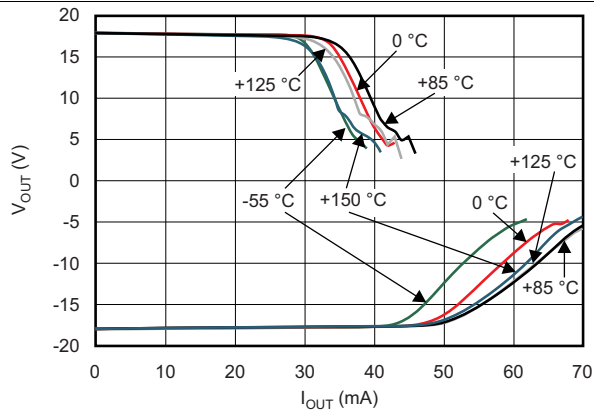

Figure 37. Output Voltage vs Output Current

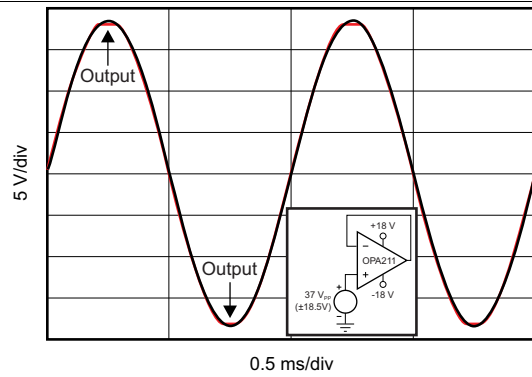

Figure 38. No Phase Reversal

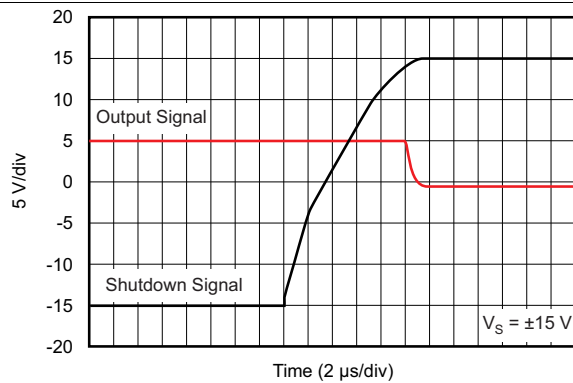

Figure 39. Turnoff Transient

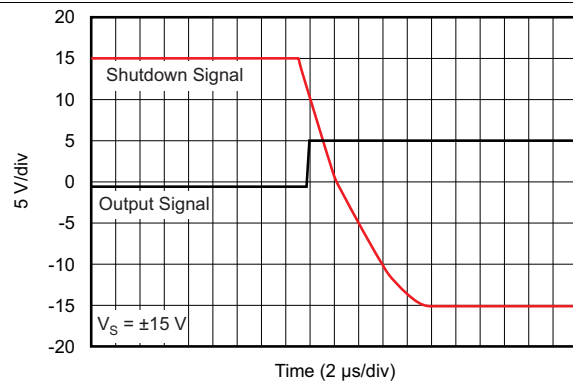

Figure 40. Turnon Transient

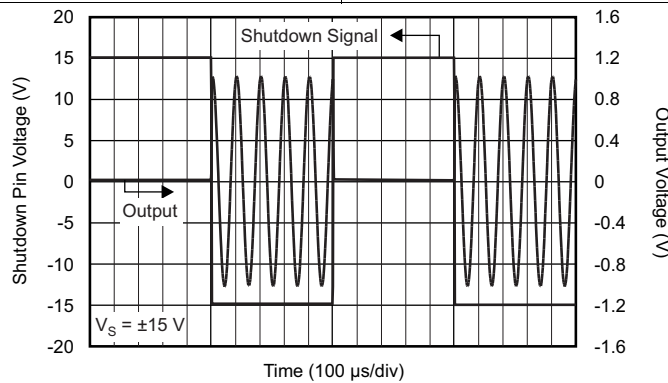

Figure 41. Turnon and Turnoff Transient

## 7 Detailed Description

### 7.1 Overview

The OPAX211 family of operational amplifiers are available in single-channel versions (OPA211) and dual-channel versions (OPA2211). Single-channel versions are available with and without shutdown. The OPAX211 family of operational amplifiers features ultra-low noise of  $1.1\text{-nV}/\sqrt{\text{Hz}}$ , low total harmonic distortion + noise of 0.00015% and wide, rail-to-rail output swing. These unique features makes the OPAX211 family a great choice for wide dynamic range applications and driving high-speed analog-to-digital converters. The OPAX211 family is protected against excessive differentially applied input voltages and is fully characterized for electromagnetic interference rejection ratio (EMIRR). The OPAX211 operates with as little as 4.5-V ( $\pm 2.25\text{-V}$ ) power supply voltage and with power supply voltages up to 36 V ( $\pm 18\text{ V}$ ). The OPAX211 family is specified to operate from  $-40^{\circ}\text{C}$  to  $+125^{\circ}\text{C}$  with little change in parametric behavior over the full temperature range.

### 7.2 Functional Block Diagram

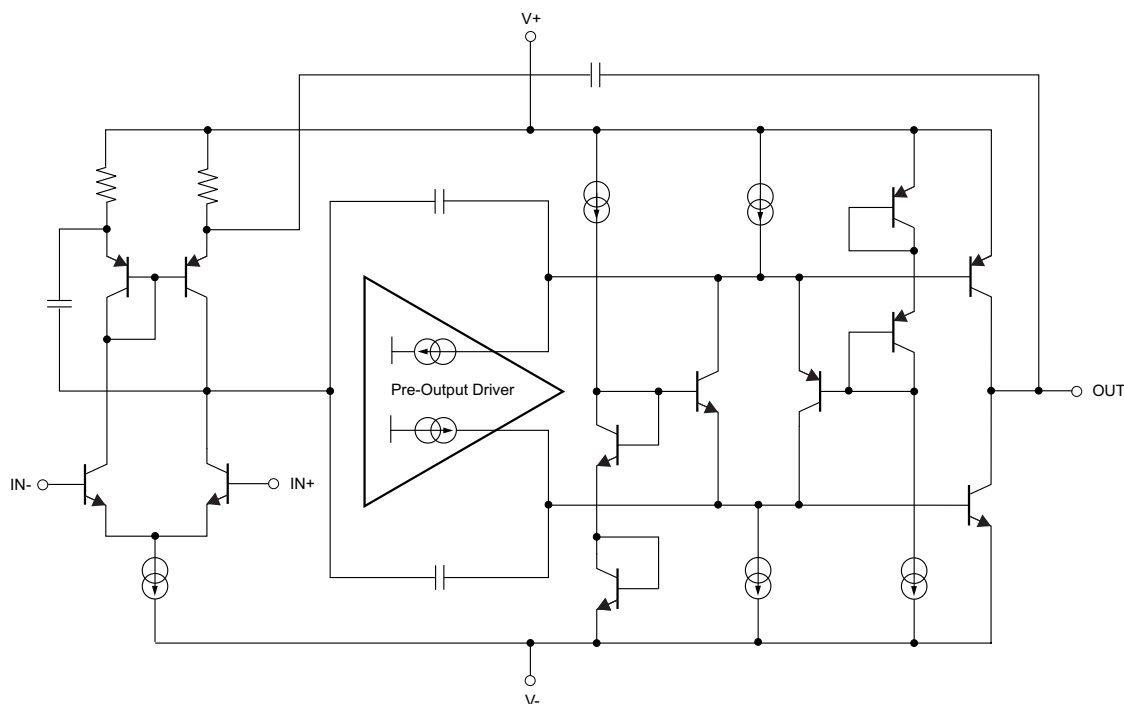

Copyright © 2017, Texas Instruments Incorporated

### 7.3 Feature Description

#### 7.3.1 Total Harmonic Distortion Measurements

OPA211 series operational amplifiers have excellent distortion characteristics. THD + noise is below 0.0001% ( $G = 1$ ,  $V_O = 3 V_{\text{RMS}}$ ) throughout the audio frequency range, 20 Hz to 20 kHz, with a 600- $\Omega$  load.

The distortion produced by OPAX211 series operational amplifiers is below the measurement limit of many commercially available distortion analyzers. However, a special test circuit shown in [Figure 43](#) can extend the measurement capabilities.

Operational amplifier distortion can be considered an internal error source that can be referred to the input. [Figure 43](#) shows a circuit that causes the operational amplifier distortion to be 101 times greater than that normally produced by the operational amplifier. The addition of  $R_3$  to the otherwise standard noninverting amplifier configuration alters the feedback factor or noise gain of the circuit. The closed-loop gain is unchanged, but the feedback available for error correction is reduced by a factor of 101, thus extending the resolution by 101.

**Feature Description (continued)**
**NOTE**

The input signal and load applied to the operational amplifier are the same as with conventional feedback without  $R_3$ . The value of  $R_3$  should be kept small to minimize its effect on the distortion measurements.

Validity of this technique can be verified by duplicating measurements at high gain and/or high frequency where the distortion is within the measurement capability of the test equipment. Measurements for this data sheet were made with an Audio Precision System Two distortion/noise analyzer, which greatly simplifies such repetitive measurements. The measurement technique can, however, be performed with manual distortion measurement instruments.

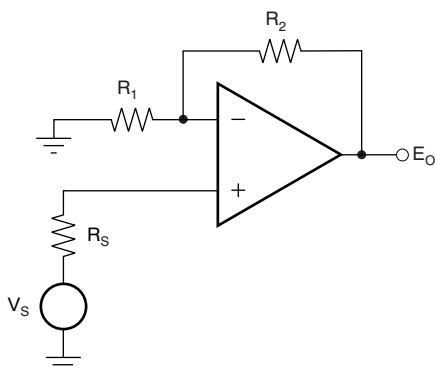
**Noise in Noninverting Gain Configuration**

Noise at the output:

$$E_O^2 = \left( 1 + \frac{R_2}{R_1} \right)^2 e_n^2 + e_1^2 + e_2^2 + (i_n R_2)^2 + e_S^2 + (i_n R_S)^2 \left( 1 + \frac{R_2}{R_1} \right)^2$$

$$\text{Where } e_S = \sqrt{4kTR_S} \times \left( 1 + \frac{R_2}{R_1} \right) = \text{thermal noise of } R_S$$

$$e_1 = \sqrt{4kTR_1} \times \left( \frac{R_2}{R_1} \right) = \text{thermal noise of } R_1$$

$$e_2 = \sqrt{4kTR_2} = \text{thermal noise of } R_2$$

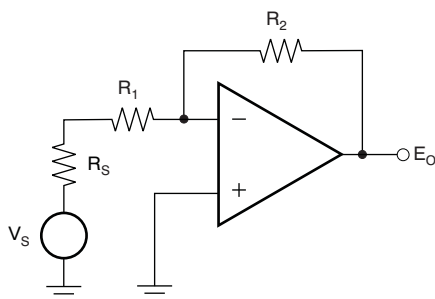
**Noise in Inverting Gain Configuration**

Noise at the output:

$$E_O^2 = \left( 1 + \frac{R_2}{R_1 + R_S} \right)^2 e_n^2 + e_1^2 + e_2^2 + (i_n R_2)^2 + e_S^2$$

$$\text{Where } e_S = \sqrt{4kTR_S} \times \left( \frac{R_2}{R_1 + R_S} \right) = \text{thermal noise of } R_S$$

$$e_1 = \sqrt{4kTR_1} \times \left( \frac{R_2}{R_1 + R_S} \right) = \text{thermal noise of } R_1$$

$$e_2 = \sqrt{4kTR_2} = \text{thermal noise of } R_2$$

For the OPA211 series op amps at 1kHz,  $e_n = 1.1\text{nV}/\sqrt{\text{Hz}}$  and  $i_n = 1.7\text{pA}/\sqrt{\text{Hz}}$ .

**Figure 42. Noise Calculation in Gain Configurations**

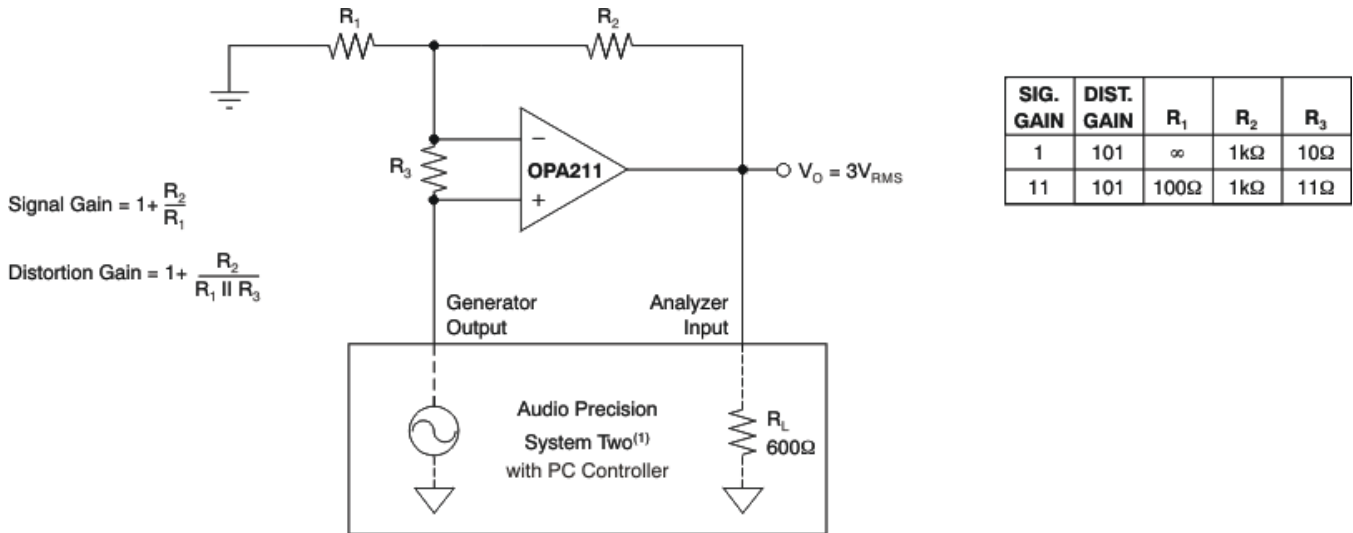

NOTE: (1) Measurement BW = 80kHz.

Figure 43. Distortion Test Circuit

## 7.4 Device Functional Modes

The OPAx211 is operational when the power-supply voltage is greater than 4.5 V ( $\pm 2.25$  V). The maximum power supply voltage for the OPAx211 series is 36 V ( $\pm 18$  V).

### 7.4.1 Shutdown

The shutdown (enable) function of the OPA211 is referenced to the positive supply voltage of the operational amplifier. A valid high disables the operational amplifier. A valid high is defined as  $(V+) - 0.35$  V of the positive supply applied to the shutdown pin. A valid low is defined as  $(V+) - 3$  V below the positive supply pin. For example, with  $V_{CC}$  at  $\pm 15$  V, the device is enabled at or below 12 V. The device is disabled at or above 14.65 V. If dual or split power supplies are used, make sure the valid high or valid low input signals are properly referred to the positive supply voltage. This pin must be connected to a valid high or low voltage or driven, and not left open-circuit. The enable and disable times are provided in the *Typical Characteristics* section (see Figure 39 through Figure 41). When disabled, the output assumes a high-impedance state.

## 8 Application and Implementation

### NOTE

Information in the following applications sections is not part of the TI component specification, and TI does not warrant its accuracy or completeness. TI's customers are responsible for determining suitability of components for their purposes. Customers should validate and test their design implementation to confirm system functionality.

### 8.1 Application Information

The OPA211 and OPA2211 are unity-gain stable, precision operational amplifiers with very-low noise. Applications with noisy or high-impedance power supplies require decoupling capacitors close to the device pins. In most cases, 0.1- $\mu$ F capacitors are adequate.

#### 8.1.1 Operating Voltage

OPA211 series operational amplifiers operate from  $\pm 2.25$ - to  $\pm 18$ -V supplies while maintaining excellent performance. The OPA211 series can operate with as little as 4.5 V between the supplies and with up to 36 V between the supplies. However, some applications do not require equal positive and negative output voltage swing. With the OPA211 series, power-supply voltages do not need to be equal. For example, the positive supply could be set to 25 V with the negative supply at  $-5$  V or vice-versa.

The common-mode voltage must be maintained within the specified range. In addition, key parameters are assured over the specified temperature range,  $T_A = -40^\circ\text{C}$  to  $+125^\circ\text{C}$ . Parameters that vary significantly with operating voltage or temperature are shown in the [Typical Characteristics](#).

#### 8.1.2 Input Protection

The input terminals of the OPA211 are protected from excessive differential voltage with back-to-back diodes, as shown in [Figure 44](#). In most circuit applications, the input protection circuitry has no consequence. However, in low-gain or  $G = 1$  circuits, fast ramping input signals can forward bias these diodes because the output of the amplifier cannot respond rapidly enough to the input ramp. This effect is shown in [Figure 30](#) of the [Typical Characteristics](#). If the input signal is fast enough to create this forward bias condition, the input signal current must be limited to 10 mA or less. If the input signal current is not inherently limited, an input series resistor can be used to limit the signal input current. This input series resistor degrades the low-noise performance of the OPA211, and is discussed in the [Noise Performance](#) section of this data sheet. [Figure 44](#) shows an example implementing a current-limiting feedback resistor.

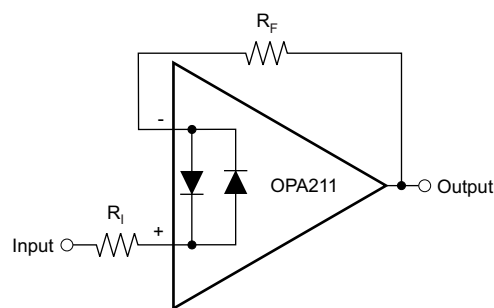

Copyright © 2017, Texas Instruments Incorporated

**Figure 44. Pulsed Operation**

## Application Information (continued)

### 8.1.3 Noise Performance

Figure 45 shows total circuit noise for varying source impedances with the operational amplifier in a unity-gain configuration (no feedback resistor network, and therefore no additional noise contributions). Two different operational amplifiers are shown with total circuit noise calculated. The OPAx211 has very low voltage noise, making the family a viable option for low source impedances (less than 2 kΩ). A similar precision operational amplifier, the OPA227, has somewhat higher voltage noise but lower current noise. It provides excellent noise performance at moderate source impedance (10 to 100 kΩ). Above 100 kΩ, a FET-input operational amplifier such as the OPA132 (very low current noise) may provide improved performance. The equation in Figure 45 is shown for the calculation of the total circuit noise.

#### NOTE

$e_n$  = voltage noise,  $I_n$  = current noise,  $R_S$  = source impedance,  $k$  = Boltzmann's constant =  $1.38 \times 10^{-23}$  J/K, and  $T$  is temperature in K.

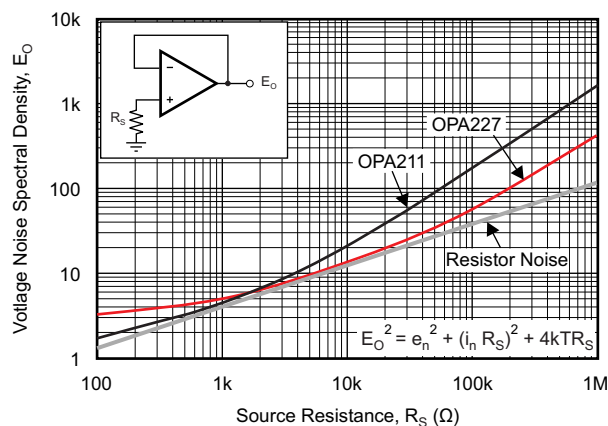

Figure 45. Noise Performance of the OPA211 and OPA227 in Unity-Gain Buffer Configuration

### 8.1.4 Basic Noise Calculations

Design of low-noise operational amplifier circuits requires careful consideration of a variety of possible noise contributors: noise from the signal source, noise generated in the operational amplifier, and noise from the feedback network resistors. The total noise of the circuit is the root-sum-square combination of all noise components.

The resistive portion of the source impedance produces thermal noise proportional to the square root of the resistance. This function is plotted in Figure 45. The source impedance is usually fixed; consequently, select the operational amplifier and the feedback resistors to minimize the respective contributions to the total noise.

Figure 45 depicts total noise for varying source impedances with the operational amplifier in a unity-gain configuration (no feedback resistor network, and therefore no additional noise contributions). The operational amplifier itself contributes both a voltage noise component and a current noise component. The voltage noise is commonly modeled as a time-varying component of the offset voltage. The current noise is modeled as the time-varying component of the input bias current and reacts with the source resistance to create a voltage component of noise. Therefore, the lowest noise operational amplifier for a given application depends on the source impedance. For low source impedance, current noise is negligible and voltage noise generally dominates. For high source impedance, current noise may dominate.

Figure 42 shows both inverting and noninverting operational amplifier circuit configurations with gain. In circuit configurations with gain, the feedback network resistors also contribute noise. The current noise of the operational amplifier reacts with the feedback resistors to create additional noise components. The feedback resistor values can generally be chosen to make these noise sources negligible. The equations for total noise are shown for both configurations.

## Application Information (continued)

### 8.1.5 EMI Rejection

The electromagnetic interference (EMI) rejection ratio, or EMIRR, describes the EMI immunity of operational amplifiers. An adverse effect that is common to many operational amplifiers is a change in the offset voltage as a result of RF signal rectification. An operational amplifier that is more efficient at rejecting this change in offset as a result of EMI has a higher EMIRR and is quantified by a decibel value. Measuring EMIRR can be performed in many ways, but this section provides the EMIRR IN+, which specifically describes the EMIRR performance when the RF signal is applied to the noninverting input pin of the operational amplifier. In general, only the noninverting input is tested for EMIRR for the following three reasons:

1. Operational amplifier input pins are known to be the most sensitive to EMI, and typically rectify RF signals better than the supply or output pins.
2. The noninverting and inverting operational amplifier inputs have symmetrical physical layouts and exhibit nearly matching EMIRR performance.
3. EMIRR is easier to measure on noninverting pins than on other pins because the noninverting input terminal can be isolated on a printed-circuit-board (PCB). This isolation allows the RF signal to be applied directly to the noninverting input terminal with no complex interactions from other components or connecting PCB traces. [Figure 46](#)

The EMIRR IN+ of the OPA211 is plotted versus frequency as shown in [Figure 46](#). If available, any dual and quad operational amplifier device versions have nearly similar EMIRR IN+ performance. The OPA211 unity-gain bandwidth is 45 MHz. EMIRR performance below this frequency denotes interfering signals that fall within the operational amplifier bandwidth.

Detailed information can also be found in the [EMI Rejection Ratio of Operational Amplifiers](#) application report, available for download from [www.ti.com](http://www.ti.com).

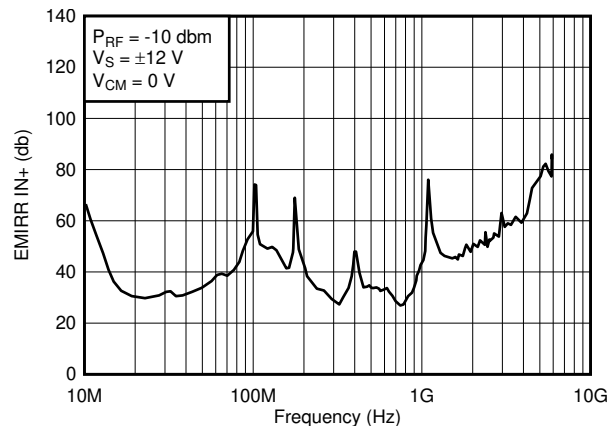

**Figure 46. OPA211 EMIRR**

[Table 1](#) shows the EMIRR IN+ values for the OPA211 at particular frequencies commonly encountered in real-world applications. Applications listed in [Table 1](#) may be centered on or operated near the particular frequency shown. This information may be of special interest to designers working with these types of applications, or working in other fields likely to encounter RF interference from broad sources, such as the industrial, scientific, and medical (ISM) radio band.



Application Information (continued)

Table 1. OPA211 EMIRR IN+ for Frequencies of Interest

FREQUENCY	APPLICATION OR ALLOCATION	EMIRR IN+
400 MHz	Mobile radio, mobile satellite, space operation, weather, radar, ultra-high frequency (UHF) applications	48.4 dB
900 MHz	Global system for mobile communications (GSM) applications, radio communication, navigation, GPS (to 1.6 GHz), GSM, aeronautical mobile, UHF applications	34.6 dB
1.8 GHz	GSM applications, mobile personal communications, broadband, satellite, L-band (1 GHz to 2 GHz)	46 dB
2.4 GHz	802.11b, 802.11g, 802.11n, Bluetooth®, mobile personal communications, industrial, scientific and medical (ISM) radio band, amateur radio and satellite, S-band (2 GHz to 4 GHz)	56.9 dB
3.6 GHz	Radiolocation, aero communication and navigation, satellite, mobile, S-band	61.5 dB
5 GHz	802.11a, 802.11n, aero communication and navigation, mobile communication, space and satellite operation, C-band (4 GHz to 8 GHz)	76.7 dB

8.1.6 EMIRR +IN Test Configuration

Figure 47 shows the circuit configuration for testing the EMIRR IN+. An RF source is connected to the operational amplifier noninverting input terminal using a transmission line. The operational amplifier is configured in a unity-gain buffer topology with the output connected to a low-pass filter (LPF) and a digital multimeter (DMM).

NOTE

A large impedance mismatch at the operational amplifier input causes a voltage reflection; however, this effect is characterized and accounted for when determining the EMIRR IN+. The resulting DC offset voltage is sampled and measured by the multimeter.

The LPF isolates the multimeter from residual RF signals that may interfere with multimeter accuracy.

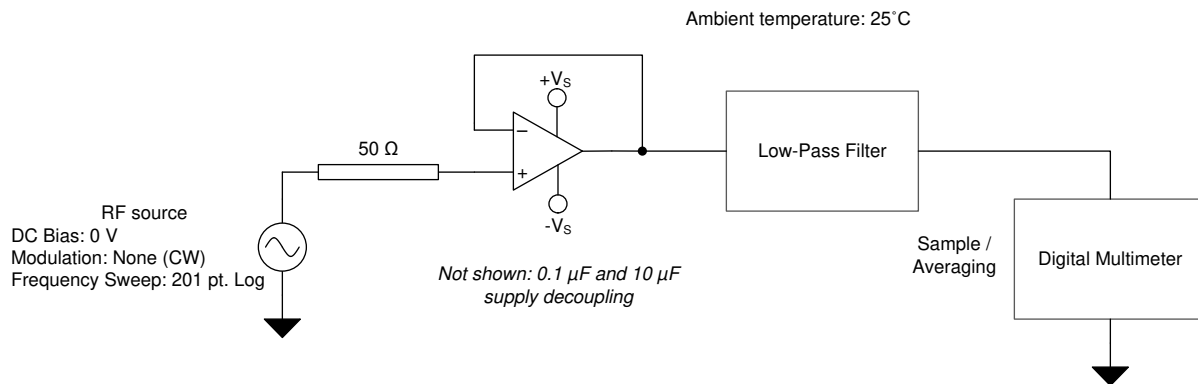

Figure 47. EMIRR +IN Test Configuration

8.1.7 Electrical Overstress

Designers often ask questions about the capability of an operational amplifier to withstand electrical overstress. These questions tend to focus on the device inputs, but may involve the supply voltage pins or even the output pin. Each of these different pin functions have electrical stress limits determined by the voltage breakdown characteristics of the particular semiconductor fabrication process and specific circuits connected to the pin. Additionally, internal electrostatic discharge (ESD) protection is built into these circuits to protect them from accidental ESD events both before and during product assembly.

It is helpful to have a good understanding of this basic ESD circuitry and its relevance to an electrical overstress event. Figure 48 shows the ESD circuits contained in the OPA211 (indicated by the dashed line area). The ESD protection circuitry involves several current-steering diodes connected from the input and output pins and routed back to the internal power-supply lines, where they meet at an absorption device internal to the operational amplifier. This protection circuitry is intended to remain inactive during normal circuit operation.

An ESD event produces a short duration, high-voltage pulse that is transformed into a short duration, high-current pulse as it discharges through a semiconductor device. The ESD protection circuits are designed to provide a current path around the operational amplifier core to prevent it from damage. The energy absorbed by the protection circuitry is then dissipated as heat.

When an ESD voltage develops across two or more of the amplifier device pins, current flows through one or more of the steering diodes. Depending on the path that the current takes, the absorption device may activate. The absorption device has a trigger, or threshold voltage, that is above the normal operating voltage of the OPA211 but below the device breakdown voltage level. Once this threshold is exceeded, the absorption device quickly activates and clamps the voltage across the supply rails to a safe level.

When the operational amplifier connects into a circuit such as that shown in [Figure 48](#), the ESD protection components are intended to remain inactive and not become involved in the application circuit operation. However, circumstances may arise where an applied voltage exceeds the operating voltage range of a given pin. Should this condition occur, there is a risk that some of the internal ESD protection circuits may be biased on, and conduct current. Any such current flow occurs through steering diode paths and rarely involves the absorption device.

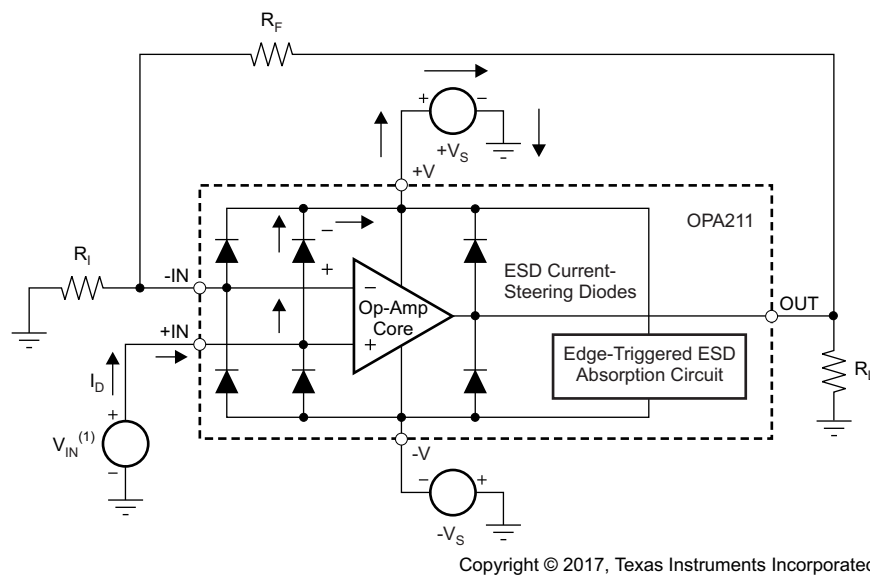

(1)  $V_{IN} = +V_S + 500 \text{ mV}$ .

**Figure 48. Equivalent Internal ESD Circuitry and the Relation to a Typical Circuit Application**

[Figure 48](#) depicts a specific example where the input voltage,  $V_{IN}$ , exceeds the positive supply voltage ( $+V_S$ ) by 500 mV or more. Much of what happens in the circuit depends on the supply characteristics. If  $+V_S$  can sink the current, one of the upper input steering diodes conducts and directs current to  $+V_S$ . Excessively high current levels can flow with increasingly higher  $V_{IN}$ . As a result, the datasheet specifications recommend that applications limit the input current to 10 mA.

If the supply is not capable of sinking the current,  $V_{IN}$  may begin sourcing current to the operational amplifier, and then take over as the source of positive supply voltage. The danger in this case is that the voltage can rise to levels that exceed the operational amplifier absolute maximum ratings. In extreme but rare cases, the absorption device triggers on while  $+V_S$  and  $-V_S$  are applied. If this event happens, a direct current path is established between the  $+V_S$  and  $-V_S$  supplies. The power dissipation of the absorption device is quickly exceeded, and the extreme internal heating destroys the operational amplifier.

Another common question involves what happens to the amplifier if an input signal is applied to the input while the power supplies  $+V_S$  and/or  $-V_S$  are at 0 V. Again, it depends on the supply characteristic while at 0 V, or at a level below the input signal amplitude. If the supplies appear as high impedance, then the operational amplifier supply current may be supplied by the input source through the current steering diodes. This state is not a normal bias condition; the amplifier most likely will not operate normally. If the supplies are low impedance, then the current through the steering diodes can become quite high. The current level depends on the ability of the input source to deliver current, and any resistance in the input path.

## 8.2 Typical Application

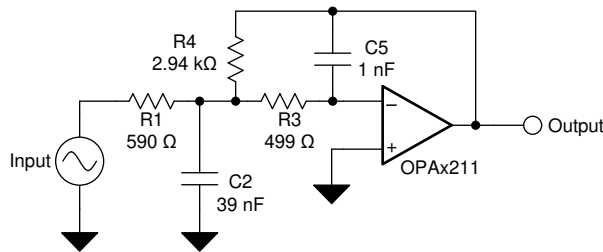

Copyright © 2017, Texas Instruments Incorporated

**Figure 49. OPAx211 Simplified Schematic**

### 8.2.1 Design Requirements

Low-pass filters are commonly employed in signal processing applications to reduce noise and prevent aliasing. The OPAx211 devices are designed to construct high-speed, high-precision active filters. Figure 49 shows a second-order low-pass filter commonly encountered in signal processing applications.

Use the following parameters for this design example:

- Gain = 5 V/V (inverting gain)
- Low-pass cutoff frequency = 25 kHz
- Second-order Chebyshev filter response with 3-dB gain peaking in the passband

### 8.2.2 Detailed Design Procedure

The infinite-gain multiple-feedback circuit for a low-pass network function is shown in Figure 50 . Use Equation 1 to calculate the voltage transfer function.

$$\frac{\text{Output}}{\text{Input}}(s) = \frac{-1/R_1 R_3 C_2 C_5}{s^2 + (s/C_2)(1/R_1 + 1/R_3 + 1/R_4) + 1/R_3 R_4 C_2 C_5} \quad (1)$$

This circuit produces a signal inversion. For this circuit, the gain at DC and the low-pass cutoff frequency are calculated by Equation 2:

$$\text{Gain} = \frac{R_4}{R_1}$$

$$f_c = \frac{1}{2\pi} \sqrt{(1/R_3 R_4 C_2 C_5)} \quad (2)$$

Software tools are readily available to simplify filter design. **WEBENCH® Filter Designer** is a simple, powerful, and easy-to-use active filter design program. The WEBENCH Filter Designer allows the user to create optimized filter designs using a selection of TI operational amplifiers and passive components from TI's vendor partners.

Available as a web based tool from the WEBENCH Design Center, **WEBENCH® Filter Designer** allows the user to design, optimize, and simulate complete multistage active filter solutions within minutes.

## Typical Application (continued)

### 8.2.3 Application Curve

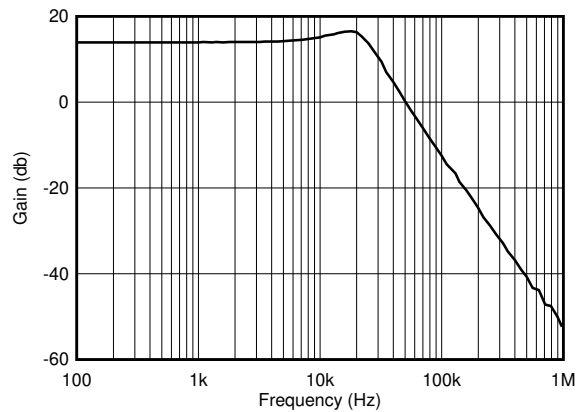

**Figure 50. OPAx211 2nd-Order 25-kHz, Chebyshev, Low-Pass Filter**

## 9 Power Supply Recommendations

The OPAx211 are specified for operation from 4.5 V to 36 V ( $\pm 2.25$  V to  $\pm 18$  V); many specifications apply from  $-40^{\circ}\text{C}$  to  $+125^{\circ}\text{C}$ . Parameters that can exhibit significant variance with regard to operating voltage or temperature are presented in the [Typical Characteristics](#).

## 10 Layout

### 10.1 Layout Guidelines

For best operational performance of the device, use good PCB layout practices, including:

- Noise can propagate into analog circuitry through the power pins of the circuit as a whole and operational amplifier itself. Bypass capacitors are used to reduce the coupled noise by providing low-impedance power sources local to the analog circuitry.
  - Connect low-ESR, 0.1- $\mu\text{F}$  ceramic bypass capacitors between each supply pin and ground, placed as close to the device as possible. A single bypass capacitor from V+ to ground is applicable for single-supply applications.
- Separate grounding for analog and digital portions of circuitry is one of the simplest and most-effective methods of noise suppression. One or more layers on multilayer PCBs are usually devoted to ground planes. A ground plane helps distribute heat and reduces EMI noise pick-up. Make sure to physically separate digital and analog grounds paying attention to the flow of the ground current. For more detailed information, see [Circuit Board Layout Techniques](#).
- In order to reduce parasitic coupling, run the input traces as far away from the supply or output traces as possible. If these traces cannot be kept separate, crossing the sensitive trace perpendicular is much better as opposed to in parallel with the noisy trace.
- Place the external components as close to the device as possible. As shown in [Figure 51](#), keeping RF and RG close to the inverting input minimizes parasitic capacitance.
- Keep the length of input traces as short as possible. Always remember that the input traces are the most sensitive part of the circuit.
- Consider a driven, low-impedance guard ring around the critical traces. A guard ring can significantly reduce leakage currents from nearby traces that are at different potentials.
- Cleaning the PCB following board assembly is recommended for best performance.
- Any precision integrated circuit may experience performance shifts due to moisture ingress into the plastic package. Following any aqueous PCB cleaning process, baking the PCB assembly is recommended to remove moisture introduced into the device packaging during the cleaning process. A low temperature, post cleaning bake at  $85^{\circ}\text{C}$  for 30 minutes is sufficient for most circumstances.

## Layout Guidelines (continued)

### 10.1.1 SON Layout Guidelines

The OPA211 is offered in an SON-8 package (also known as SON). The SON package is a QFN package with lead contacts on only two sides of the bottom of the package. This leadless package maximizes board space and enhances thermal and electrical characteristics through an exposed pad.

SON packages are physically small, and have a smaller routing area, improved thermal performance, and improved electrical parasitics. Additionally, the absence of external leads eliminates bent-lead issues.

The SON package can be easily mounted using standard printed circuit board (PCB) assembly techniques. See the [QFN/SON PCB Attachment application note](#) and the [Quad Flatpack No-Lead Logic Packages](#) application report, both available for download at [www.ti.com](http://www.ti.com).

#### NOTE

The exposed leadframe die pad on the bottom of the package must be connected to V<sub>-</sub>. Soldering the thermal pad improves heat dissipation and enables specified device performance.

The exposed leadframe die pad on the SON package should be soldered to a thermal pad on the PCB. A mechanical drawing showing an example layout is attached at the end of this data sheet. Refinements to this layout may be necessary based on assembly process requirements. Mechanical drawings located at the end of this data sheet list the physical dimensions for the package and pad. The five holes in the landing pattern are optional, and are intended for use with thermal vias that connect the leadframe die pad to the heat sink area on the PCB.

Soldering the exposed pad significantly improves board-level reliability during temperature cycling, key push, package shear, and similar board-level tests. Even with applications that have low-power dissipation, the exposed pad must be soldered to the PCB to provide structural integrity and long-term reliability.

### 10.2 Layout Example

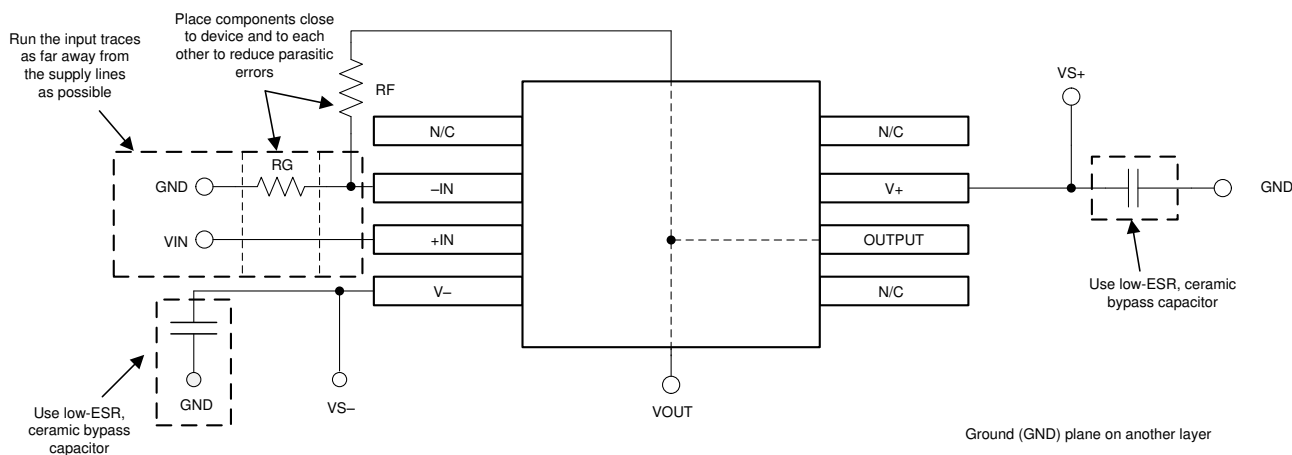

Copyright © 2017, Texas Instruments Incorporated

**Figure 51. Layout Example**

## 11 Device and Documentation Support

### 11.1 Device Support

#### 11.1.1 Development Support

##### 11.1.1.1 TINA-TI™ (Free Software Download)

TINA™ is a simple, powerful, and easy-to-use circuit simulation program based on a SPICE engine. TINA-TI™ is a free, fully-functional version of the TINA software, preloaded with a library of macro models in addition to a range of both passive and active models. TINA-TI provides all the conventional DC, transient, and frequency domain analysis of SPICE, as well as additional design capabilities.

Available as a [free download](#) from the WEBENCH® Design Center, TINA-TI offers extensive post-processing capability that allows users to format results in a variety of ways. Virtual instruments offer the ability to select input waveforms and probe circuit nodes, voltages, and waveforms, creating a dynamic quick-start tool.

#### NOTE

These files require that either the TINA software (from DesignSoft™) or TINA-TI software be installed. Download the free TINA-TI software from the [TINA-TI folder](#).

##### 11.1.1.2 TI Precision Designs

The OPAx211 is featured in several TI Precision Designs, available online at <http://www.ti.com/ww/en/analog/precision-designs/>. TI Precision Designs are analog solutions created by TI's precision analog applications experts and offer the theory of operation, component selection, simulation, complete PCB schematic and layout, bill of materials, and measured performance of many useful circuits.

##### 11.1.1.3 WEBENCH® Filter Designer

[WEBENCH® Filter Designer](#) is a simple, powerful, and easy-to-use active filter design program. The WEBENCH Filter Designer the user to create optimized filter designs using a selection of TI operational amplifiers and passive components from TI's vendor partners.

Available as a web based tool from the WEBENCH® Design Center, [WEBENCH® Filter Designer](#) allows the user to design, optimize, and simulate complete multistage active filter solutions within minutes.

### 11.2 Documentation Support

#### 11.2.1 Related Documentation

For related documentation see:

- Texas Instruments, [Circuit Board Layout Techniques](#)
- Texas Instruments, [Op Amps for Everyone](#)
- Texas Instruments, [OPA211, OPA211A, OP2211, OPA2211A EMI Immunity Performance \(Rev. A\)](#)
- Texas Instruments, [Operational amplifier gain stability, Part 3: AC gain-error analysis](#)
- Texas Instruments, [Operational amplifier gain stability, Part 2: DC gain-error analysis](#)
- Texas Instruments, [Using infinite-gain, MFB filter topology in fully differential active filters](#)
- Texas Instruments, [Op Amp Performance Analysis](#)
- Texas Instruments, [Single-Supply Operation of Operational Amplifiers](#)
- Texas Instruments, [Tuning in Amplifiers](#)
- Texas Instruments, [Shelf-Life Evaluation of Lead-Free Component Finishes](#)

### 11.3 Related Links

Table 2 lists quick access links. Categories include technical documents, support and community resources, tools and software, and quick access to sample or buy.

**Table 2. Related Links**

PARTS	PRODUCT FOLDER	ORDER NOW	TECHNICAL DOCUMENTS	TOOLS & SOFTWARE	SUPPORT & COMMUNITY
OPA211	<a href="#">Click here</a>	<a href="#">Click here</a>	<a href="#">Click here</a>	<a href="#">Click here</a>	<a href="#">Click here</a>
OPA2211	<a href="#">Click here</a>	<a href="#">Click here</a>	<a href="#">Click here</a>	<a href="#">Click here</a>	<a href="#">Click here</a>

### 11.4 Receiving Notification of Documentation Updates

To receive notification of documentation updates — go to the product folder for your device on ti.com. In the upper right-hand corner, click the *Alert me* button to register and receive a weekly digest of product information that has changed (if any). For change details, check the revision history of any revised document.

### 11.5 Support Resources

TI E2E™ support forums are an engineer's go-to source for fast, verified answers and design help — straight from the experts. Search existing answers or ask your own question to get the quick design help you need.

Linked content is provided "AS IS" by the respective contributors. They do not constitute TI specifications and do not necessarily reflect TI's views; see TI's [Terms of Use](#).

### 11.6 Trademarks

PowerPAD, TINA-TI, E2E are trademarks of Texas Instruments.

WEBENCH is a registered trademark of Texas Instruments.

Bluetooth is a registered trademark of Bluetooth SIG, Inc.

TINA, DesignSoft are trademarks of DesignSoft, Inc.

All other trademarks are the property of their respective owners.

### 11.7 Electrostatic Discharge Caution



This integrated circuit can be damaged by ESD. Texas Instruments recommends that all integrated circuits be handled with appropriate precautions. Failure to observe proper handling and installation procedures can cause damage.

ESD damage can range from subtle performance degradation to complete device failure. Precision integrated circuits may be more susceptible to damage because very small parametric changes could cause the device not to meet its published specifications.

### 11.8 Glossary

[SLYZ022](#) — *TI Glossary*.

This glossary lists and explains terms, acronyms, and definitions.

## 12 Mechanical, Packaging, and Orderable Information

The following pages include mechanical, packaging, and orderable information. This information is the most current data available for the designated devices. This data is subject to change without notice and revision of this document. For browser-based versions of this data sheet, refer to the left-hand navigation.

**PACKAGING INFORMATION**

Orderable Device	Status (1)	Package Type	Package Drawing	Pins	Package Qty	Eco Plan (2)	Lead/Ball Finish (6)	MSL Peak Temp (3)	Op Temp (°C)	Device Marking (4/5)	Samples
OPA211AID	ACTIVE	SOIC	D	8	75	Green (RoHS & no Sb/Br)	NIPDAU	Level-2-260C-1 YEAR	-40 to 125	OPA 211 A	<a href="#">Samples</a>
OPA211AIDG4	ACTIVE	SOIC	D	8	75	Green (RoHS & no Sb/Br)	NIPDAU	Level-2-260C-1 YEAR	-40 to 125	OPA 211 A	<a href="#">Samples</a>
OPA211AIDGKR	ACTIVE	VSSOP	DGK	8	2500	Green (RoHS & no Sb/Br)	Call TI   NIPDAU	Level-2-260C-1 YEAR	-40 to 125	OBCQ	<a href="#">Samples</a>
OPA211AIDGKT	ACTIVE	VSSOP	DGK	8	250	Green (RoHS & no Sb/Br)	Call TI   NIPDAU	Level-2-260C-1 YEAR	-40 to 125	OBCQ	<a href="#">Samples</a>
OPA211AIDGKTG4	ACTIVE	VSSOP	DGK	8	250	Green (RoHS & no Sb/Br)	Call TI	Level-2-260C-1 YEAR	-40 to 125	OBCQ	<a href="#">Samples</a>
OPA211AIDR	ACTIVE	SOIC	D	8	2500	Green (RoHS & no Sb/Br)	NIPDAU	Level-2-260C-1 YEAR	-40 to 125	OPA 211 A	<a href="#">Samples</a>
OPA211AIDRG4	ACTIVE	SOIC	D	8	2500	Green (RoHS & no Sb/Br)	NIPDAU	Level-2-260C-1 YEAR	-40 to 125	OPA 211 A	<a href="#">Samples</a>
OPA211AIDRGR	ACTIVE	SON	DRG	8	3000	Green (RoHS & no Sb/Br)	NIPDAU	Level-2-260C-1 YEAR	-40 to 125	OBDQ	<a href="#">Samples</a>
OPA211AIDRGT	ACTIVE	SON	DRG	8	250	Green (RoHS & no Sb/Br)	NIPDAU	Level-2-260C-1 YEAR	-40 to 125	OBDQ	<a href="#">Samples</a>
OPA211AIDRGTG4	ACTIVE	SON	DRG	8	250	Green (RoHS & no Sb/Br)	NIPDAU	Level-2-260C-1 YEAR	-40 to 125	OBDQ	<a href="#">Samples</a>
OPA211ID	ACTIVE	SOIC	D	8	75	Green (RoHS & no Sb/Br)	NIPDAU	Level-2-260C-1 YEAR	-40 to 125	OPA 211	<a href="#">Samples</a>
OPA211IDGKR	ACTIVE	VSSOP	DGK	8	2500	Green (RoHS & no Sb/Br)	Call TI   NIPDAU	Level-2-260C-1 YEAR	-40 to 125	OBCQ	<a href="#">Samples</a>
OPA211IDGKT	ACTIVE	VSSOP	DGK	8	250	Green (RoHS & no Sb/Br)	Call TI   NIPDAU	Level-2-260C-1 YEAR	-40 to 125	OBCQ	<a href="#">Samples</a>
OPA211IDR	ACTIVE	SOIC	D	8	2500	Green (RoHS & no Sb/Br)	NIPDAU	Level-2-260C-1 YEAR	-40 to 125	OPA 211	<a href="#">Samples</a>
OPA211IDRGR	ACTIVE	SON	DRG	8	3000	Green (RoHS & no Sb/Br)	NIPDAU	Level-2-260C-1 YEAR	-40 to 125	OBDQ	<a href="#">Samples</a>



Orderable Device	Status (1)	Package Type	Package Drawing	Pins	Package Qty	Eco Plan (2)	Lead/Ball Finish (6)	MSL Peak Temp (3)	Op Temp (°C)	Device Marking (4/5)	Samples
OPA211IDRGT	ACTIVE	SON	DRG	8	250	Green (RoHS & no Sb/Br)	NIPDAU	Level-2-260C-1 YEAR	-40 to 125	OBDQ	<a href="#">Samples</a>
OPA2211AIDDA	ACTIVE	SO PowerPAD	DDA	8	75	Green (RoHS & no Sb/Br)	NIPDAU	Level-1-260C-UNLIM	-40 to 125	OPA 2211 A	<a href="#">Samples</a>
OPA2211AIDDAR	ACTIVE	SO PowerPAD	DDA	8	2500	Green (RoHS & no Sb/Br)	NIPDAU	Level-1-260C-UNLIM	-40 to 125	OPA 2211 A	<a href="#">Samples</a>
OPA2211AIDRGR	ACTIVE	SON	DRG	8	3000	Green (RoHS & no Sb/Br)	NIPDAU	Level-2-260C-1 YEAR	-40 to 125	OBHQ	<a href="#">Samples</a>
OPA2211AIDRGT	ACTIVE	SON	DRG	8	250	Green (RoHS & no Sb/Br)	NIPDAU	Level-2-260C-1 YEAR	-40 to 125	OBHQ	<a href="#">Samples</a>

(1) The marketing status values are defined as follows:

**ACTIVE:** Product device recommended for new designs.

**LIFEBUY:** TI has announced that the device will be discontinued, and a lifetime-buy period is in effect.

**NRND:** Not recommended for new designs. Device is in production to support existing customers, but TI does not recommend using this part in a new design.

**PREVIEW:** Device has been announced but is not in production. Samples may or may not be available.

**OBsolete:** TI has discontinued the production of the device.

(2) **RoHS:** TI defines "RoHS" to mean semiconductor products that are compliant with the current EU RoHS requirements for all 10 RoHS substances, including the requirement that RoHS substance do not exceed 0.1% by weight in homogeneous materials. Where designed to be soldered at high temperatures, "RoHS" products are suitable for use in specified lead-free processes. TI may reference these types of products as "Pb-Free".

**RoHS Exempt:** TI defines "RoHS Exempt" to mean products that contain lead but are compliant with EU RoHS pursuant to a specific EU RoHS exemption.

**Green:** TI defines "Green" to mean the content of Chlorine (Cl) and Bromine (Br) based flame retardants meet JS709B low halogen requirements of <=1000ppm threshold. Antimony trioxide based flame retardants must also meet the <=1000ppm threshold requirement.

(3) MSL, Peak Temp. - The Moisture Sensitivity Level rating according to the JEDEC industry standard classifications, and peak solder temperature.

(4) There may be additional marking, which relates to the logo, the lot trace code information, or the environmental category on the device.

(5) Multiple Device Markings will be inside parentheses. Only one Device Marking contained in parentheses and separated by a "~" will appear on a device. If a line is indented then it is a continuation of the previous line and the two combined represent the entire Device Marking for that device.

(6) Lead/Ball Finish - Orderable Devices may have multiple material finish options. Finish options are separated by a vertical ruled line. Lead/Ball Finish values may wrap to two lines if the finish value exceeds the maximum column width.

**Important Information and Disclaimer:** The information provided on this page represents TI's knowledge and belief as of the date that it is provided. TI bases its knowledge and belief on information provided by third parties, and makes no representation or warranty as to the accuracy of such information. Efforts are underway to better integrate information from third parties. TI has taken and continues to take reasonable steps to provide representative and accurate information but may not have conducted destructive testing or chemical analysis on incoming materials and chemicals. TI and TI suppliers consider certain information to be proprietary, and thus CAS numbers and other limited information may not be available for release.

In no event shall TI's liability arising out of such information exceed the total purchase price of the TI part(s) at issue in this document sold by TI to Customer on an annual basis.

**OTHER QUALIFIED VERSIONS OF OPA211 :**

- Enhanced Product: [OPA211-EP](#)

NOTE: Qualified Version Definitions:

- Enhanced Product - Supports Defense, Aerospace and Medical Applications

**TAPE AND REEL INFORMATION**

**QUADRANT ASSIGNMENTS FOR PIN 1 ORIENTATION IN TAPE**

\*All dimensions are nominal

Device	Package Type	Package Drawing	Pins	SPQ	Reel Diameter (mm)	Reel Width W1 (mm)	A0 (mm)	B0 (mm)	K0 (mm)	P1 (mm)	W (mm)	Pin1 Quadrant
OPA211AIDGKR	VSSOP	DGK	8	2500	330.0	12.4	5.3	3.4	1.4	8.0	12.0	Q1
OPA211AIDGKT	VSSOP	DGK	8	250	180.0	12.4	5.3	3.4	1.4	8.0	12.0	Q1
OPA211AIDR	SOIC	D	8	2500	330.0	12.4	6.4	5.2	2.1	8.0	12.0	Q1
OPA211AIDRGR	SON	DRG	8	3000	330.0	12.4	3.3	3.3	1.1	8.0	12.0	Q2
OPA211AIDRGT	SON	DRG	8	250	180.0	12.4	3.3	3.3	1.1	8.0	12.0	Q2
OPA211IDGKR	VSSOP	DGK	8	2500	330.0	12.4	5.3	3.4	1.4	8.0	12.0	Q1
OPA211IDGKT	VSSOP	DGK	8	250	180.0	12.4	5.3	3.4	1.4	8.0	12.0	Q1
OPA211IDR	SOIC	D	8	2500	330.0	12.4	6.4	5.2	2.1	8.0	12.0	Q1
OPA211IDRGR	SON	DRG	8	3000	330.0	12.4	3.3	3.3	1.1	8.0	12.0	Q2
OPA211IDRGT	SON	DRG	8	250	180.0	12.4	3.3	3.3	1.1	8.0	12.0	Q2
OPA2211AIDAR	SO Power PAD	DDA	8	2500	330.0	12.4	6.4	5.2	2.1	8.0	12.0	Q1
OPA2211AIDRGR	SON	DRG	8	3000	330.0	12.4	3.3	3.3	1.1	8.0	12.0	Q2
OPA2211AIDRGT	SON	DRG	8	250	180.0	12.4	3.3	3.3	1.1	8.0	12.0	Q2

**TAPE AND REEL BOX DIMENSIONS**



\*All dimensions are nominal

Device	Package Type	Package Drawing	Pins	SPQ	Length (mm)	Width (mm)	Height (mm)
OPA211AIDGKR	VSSOP	DGK	8	2500	367.0	367.0	35.0
OPA211AIDGKT	VSSOP	DGK	8	250	210.0	185.0	35.0
OPA211AIDR	SOIC	D	8	2500	367.0	367.0	35.0
OPA211AIDRGR	SON	DRG	8	3000	367.0	367.0	35.0
OPA211AIDRGT	SON	DRG	8	250	210.0	185.0	35.0
OPA211IDGKR	VSSOP	DGK	8	2500	367.0	367.0	35.0
OPA211IDGKT	VSSOP	DGK	8	250	210.0	185.0	35.0
OPA211IDR	SOIC	D	8	2500	367.0	367.0	35.0
OPA211IDRGR	SON	DRG	8	3000	367.0	367.0	35.0
OPA211IDRGT	SON	DRG	8	250	210.0	185.0	35.0
OPA2211AIDDAR	SO PowerPAD	DDA	8	2500	367.0	367.0	35.0
OPA2211AIDRGR	SON	DRG	8	3000	367.0	367.0	35.0
OPA2211AIDRGT	SON	DRG	8	250	210.0	185.0	35.0

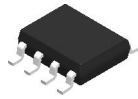

Images above are just a representation of the package family, actual package may vary.  
Refer to the product data sheet for package details.

# DDA0008J



# PACKAGE OUTLINE

## PowerPAD™ SOIC - 1.7 mm max height

PLASTIC SMALL OUTLINE

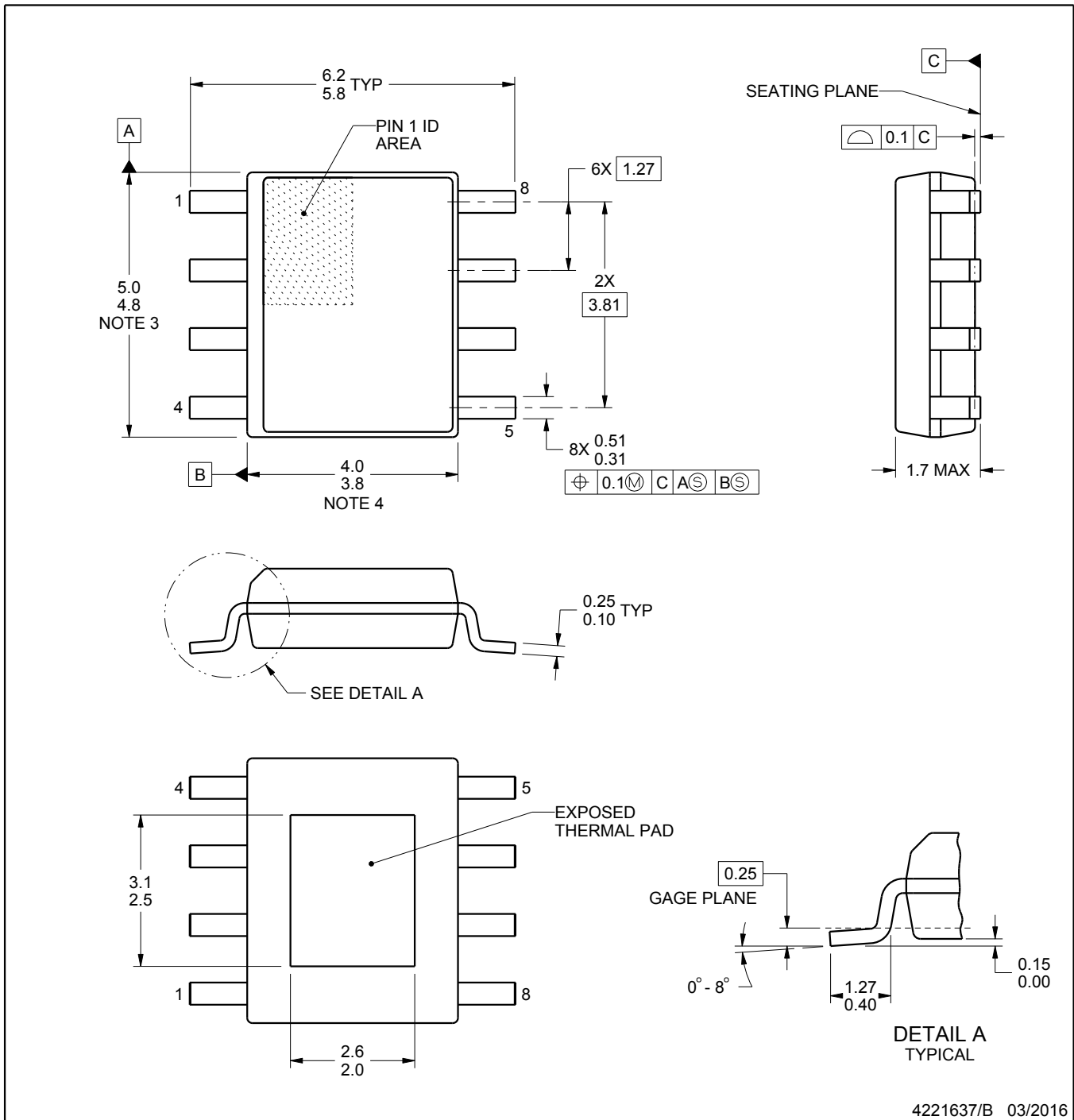

4221637/B 03/2016

PowerPAD is a trademark of Texas Instruments.

### NOTES:

1. All linear dimensions are in millimeters. Any dimensions in parenthesis are for reference only. Dimensioning and tolerancing per ASME Y14.5M.
2. This drawing is subject to change without notice.
3. This dimension does not include mold flash, protrusions, or gate burrs. Mold flash, protrusions, or gate burrs shall not exceed 0.15 mm per side.
4. This dimension does not include interlead flash. Interlead flash shall not exceed 0.25 mm per side.
5. Reference JEDEC registration MS-012, variation BA.

# EXAMPLE BOARD LAYOUT

DDA0008J

PowerPAD™ SOIC - 1.7 mm max height

PLASTIC SMALL OUTLINE

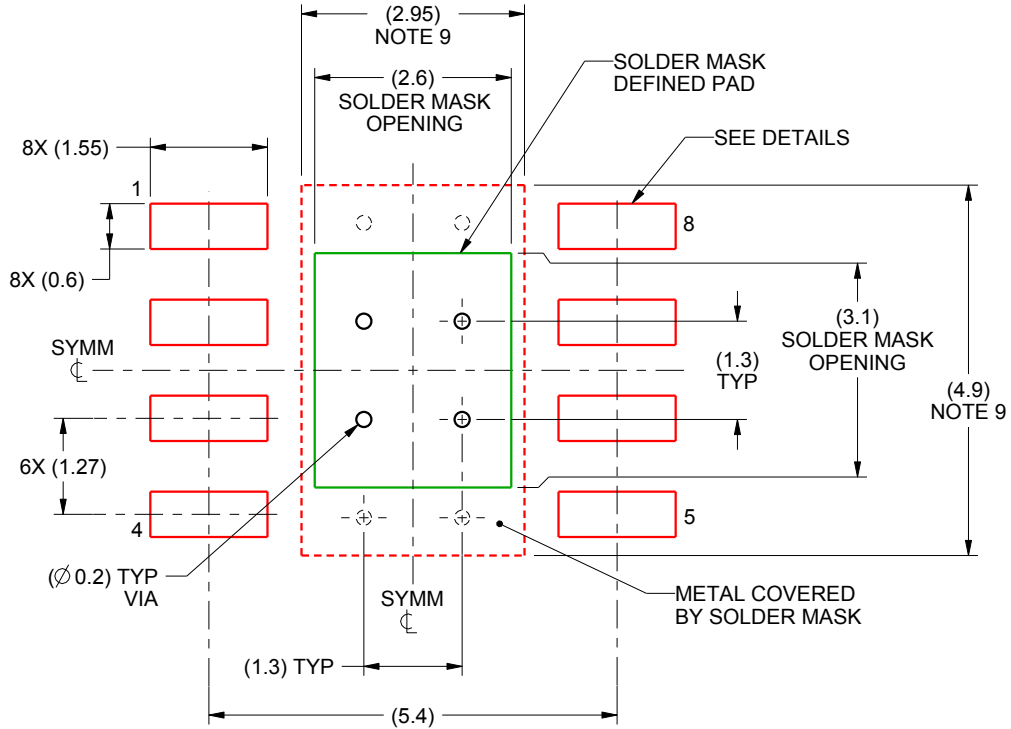

LAND PATTERN EXAMPLE  
SCALE:10X

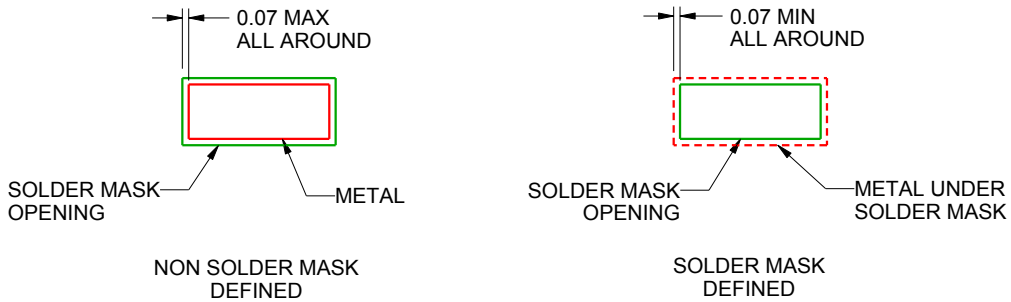

SOLDER MASK DETAILS

4221637/B 03/2016

NOTES: (continued)

- 6. Publication IPC-7351 may have alternate designs.
- 7. Solder mask tolerances between and around signal pads can vary based on board fabrication site.
- 8. This package is designed to be soldered to a thermal pad on the board. For more information, see Texas Instruments literature numbers SLMA002 ([www.ti.com/lit/slma002](http://www.ti.com/lit/slma002)) and SLMA004 ([www.ti.com/lit/slma004](http://www.ti.com/lit/slma004)).
- 9. Size of metal pad may vary due to creepage requirement.

# EXAMPLE STENCIL DESIGN

DDA0008J

PowerPAD™ SOIC - 1.7 mm max height

PLASTIC SMALL OUTLINE

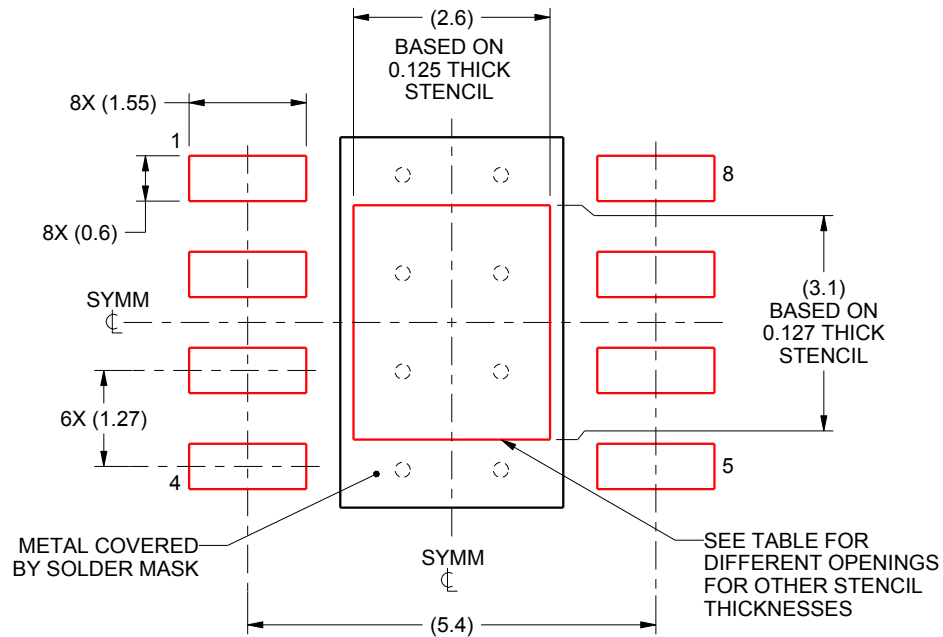

SOLDER PASTE EXAMPLE  
 EXPOSED PAD  
 100% PRINTED SOLDER COVERAGE BY AREA  
 SCALE:10X

STENCIL THICKNESS	SOLDER STENCIL OPENING
0.1	2.91 X 3.47
0.125	2.6 X 3.1 (SHOWN)
0.150	2.37 X 2.83
0.175	2.20 X 2.62

4221637/B 03/2016

NOTES: (continued)

- 10. Laser cutting apertures with trapezoidal walls and rounded corners may offer better paste release. IPC-7525 may have alternate design recommendations.
- 11. Board assembly site may have different recommendations for stencil design.





D0008A

# PACKAGE OUTLINE

SOIC - 1.75 mm max height

SMALL OUTLINE INTEGRATED CIRCUIT



4214825/C 02/2019

### NOTES:

1. Linear dimensions are in inches [millimeters]. Dimensions in parenthesis are for reference only. Controlling dimensions are in inches. Dimensioning and tolerancing per ASME Y14.5M.
2. This drawing is subject to change without notice.
3. This dimension does not include mold flash, protrusions, or gate burrs. Mold flash, protrusions, or gate burrs shall not exceed .006 [0.15] per side.
4. This dimension does not include interlead flash.
5. Reference JEDEC registration MS-012, variation AA.

# EXAMPLE BOARD LAYOUT

D0008A

SOIC - 1.75 mm max height

SMALL OUTLINE INTEGRATED CIRCUIT



LAND PATTERN EXAMPLE  
 EXPOSED METAL SHOWN  
 SCALE:8X



SOLDER MASK DETAILS

4214825/C 02/2019

NOTES: (continued)

- 6. Publication IPC-7351 may have alternate designs.
- 7. Solder mask tolerances between and around signal pads can vary based on board fabrication site.

# EXAMPLE STENCIL DESIGN

D0008A

SOIC - 1.75 mm max height

SMALL OUTLINE INTEGRATED CIRCUIT



SOLDER PASTE EXAMPLE  
BASED ON .005 INCH [0.125 MM] THICK STENCIL  
SCALE:8X

4214825/C 02/2019

NOTES: (continued)

8. Laser cutting apertures with trapezoidal walls and rounded corners may offer better paste release. IPC-7525 may have alternate design recommendations.
9. Board assembly site may have different recommendations for stencil design.





- NOTES:
- A. All linear dimensions are in millimeters.
  - B. This drawing is subject to change without notice.
  - C. Publication IPC-7351 is recommended for alternate designs.
  - D. Laser cutting apertures with trapezoidal walls and also rounding corners will offer better paste release. Customers should contact their board assembly site for stencil design recommendations. Refer to IPC-7525 for other stencil recommendations.
  - E. Customers should contact their board fabrication site for solder mask tolerances between and around signal pads.

DRG (S-PWSON-N8)

PLASTIC SMALL OUTLINE NO-LEAD



- NOTES:
- A. All linear dimensions are in millimeters. Dimensioning and tolerancing per ASME Y14.5M-1994.
  - B. This drawing is subject to change without notice.
  - C. SON (Small Outline No-Lead) package configuration.
  - D. The package thermal pad must be soldered to the board for thermal and mechanical performance. See the Product Data Sheet for details regarding the exposed thermal pad dimensions.
  - E. JEDEC MO-229 package registration pending.

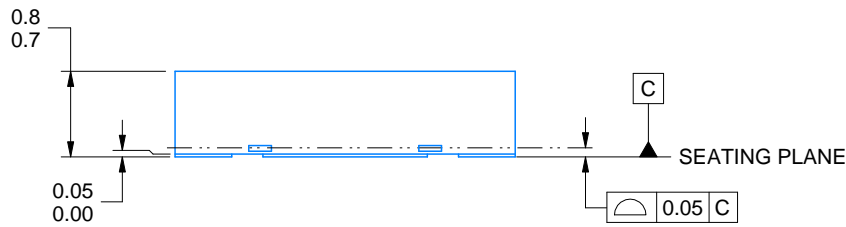
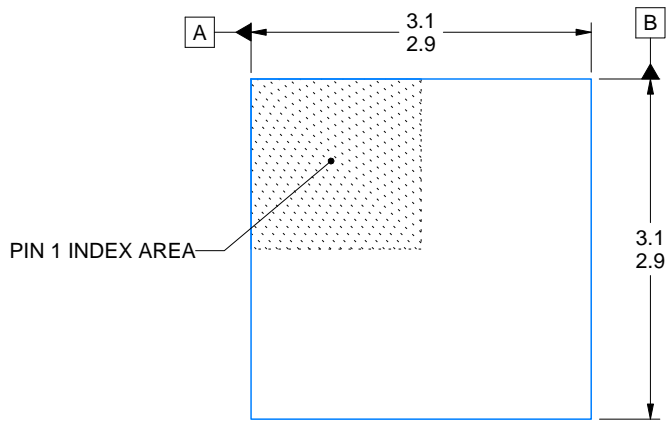
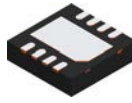

DIMENSION A	
OPTION 01	(0.1)
OPTION 02	(0.2)

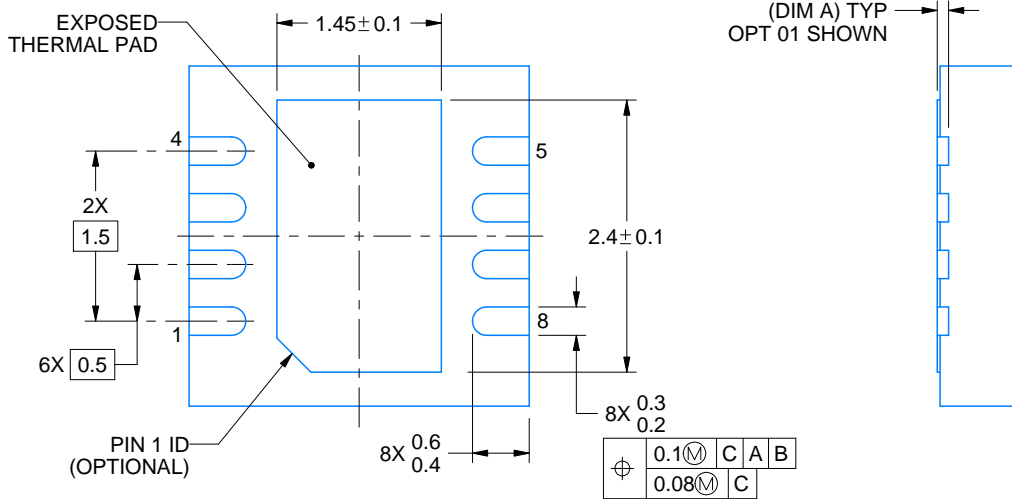

4218886/A 01/2020

NOTES:

1. All linear dimensions are in millimeters. Any dimensions in parenthesis are for reference only. Dimensioning and tolerancing per ASME Y14.5M.
2. This drawing is subject to change without notice.
3. The package thermal pad must be soldered to the printed circuit board for thermal and mechanical performance.

# EXAMPLE BOARD LAYOUT

DRG0008B

WSON - 0.8 mm max height

PLASTIC SMALL OUTLINE - NO LEAD

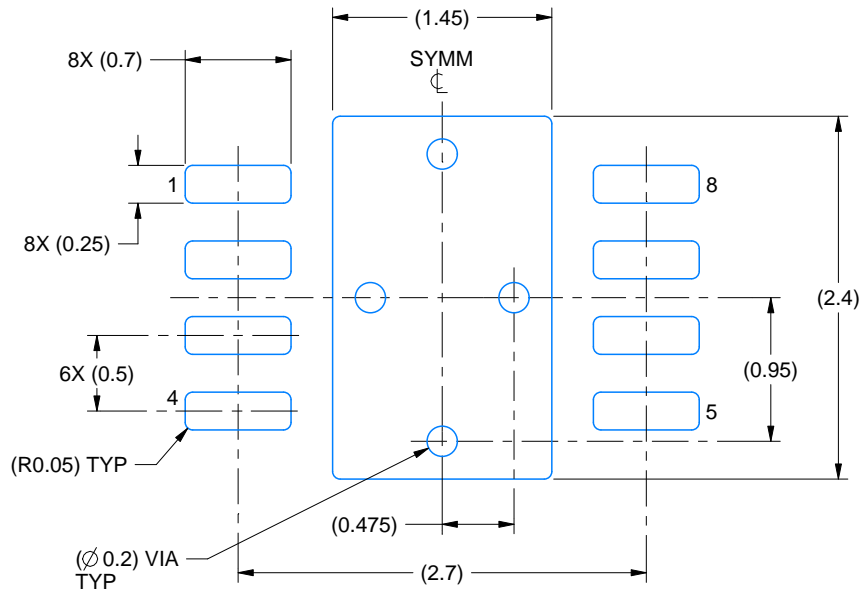

LAND PATTERN EXAMPLE  
SCALE:20X

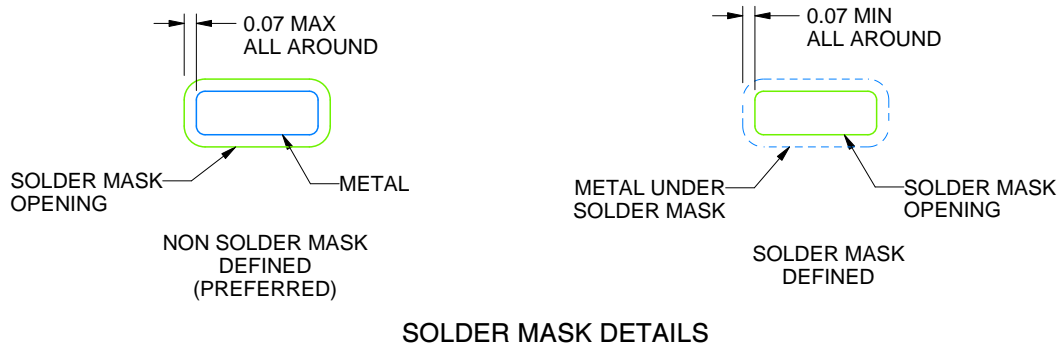

SOLDER MASK DETAILS

4218886/A 01/2020

NOTES: (continued)

4. This package is designed to be soldered to a thermal pad on the board. For more information, see Texas Instruments literature number SLUA271 ([www.ti.com/lit/slua271](http://www.ti.com/lit/slua271)).
5. Vias are optional depending on application, refer to device data sheet. If any vias are implemented, refer to their locations shown on this view. It is recommended that vias under paste be filled, plugged or tented.



# EXAMPLE STENCIL DESIGN

DRG0008B

WSO - 0.8 mm max height

PLASTIC SMALL OUTLINE - NO LEAD

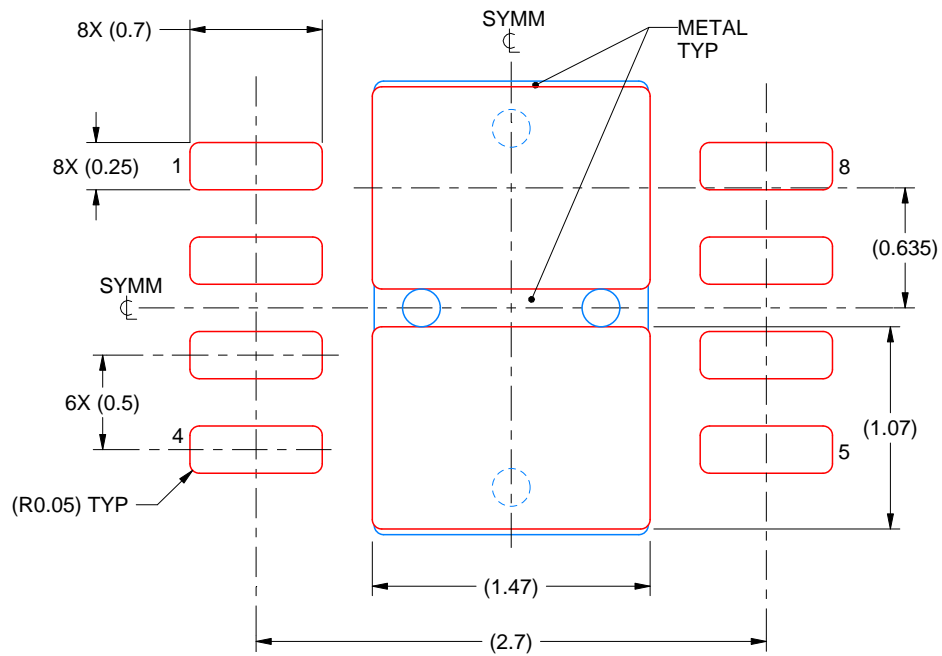

SOLDER PASTE EXAMPLE  
BASED ON 0.125 mm THICK STENCIL

EXPOSED PAD  
82% PRINTED SOLDER COVERAGE BY AREA  
SCALE:25X

4218886/A 01/2020

NOTES: (continued)

6. Laser cutting apertures with trapezoidal walls and rounded corners may offer better paste release. IPC-7525 may have alternate design recommendations.

## IMPORTANT NOTICE AND DISCLAIMER

TI PROVIDES TECHNICAL AND RELIABILITY DATA (INCLUDING DATASHEETS), DESIGN RESOURCES (INCLUDING REFERENCE DESIGNS), APPLICATION OR OTHER DESIGN ADVICE, WEB TOOLS, SAFETY INFORMATION, AND OTHER RESOURCES "AS IS" AND WITH ALL FAULTS, AND DISCLAIMS ALL WARRANTIES, EXPRESS AND IMPLIED, INCLUDING WITHOUT LIMITATION ANY IMPLIED WARRANTIES OF MERCHANTABILITY, FITNESS FOR A PARTICULAR PURPOSE OR NON-INFRINGEMENT OF THIRD PARTY INTELLECTUAL PROPERTY RIGHTS.

These resources are intended for skilled developers designing with TI products. You are solely responsible for (1) selecting the appropriate TI products for your application, (2) designing, validating and testing your application, and (3) ensuring your application meets applicable standards, and any other safety, security, or other requirements. These resources are subject to change without notice. TI grants you permission to use these resources only for development of an application that uses the TI products described in the resource. Other reproduction and display of these resources is prohibited. No license is granted to any other TI intellectual property right or to any third party intellectual property right. TI disclaims responsibility for, and you will fully indemnify TI and its representatives against, any claims, damages, costs, losses, and liabilities arising out of your use of these resources.

TI's products are provided subject to TI's Terms of Sale ([www.ti.com/legal/termsofsale.html](http://www.ti.com/legal/termsofsale.html)) or other applicable terms available either on [ti.com](http://ti.com) or provided in conjunction with such TI products. TI's provision of these resources does not expand or otherwise alter TI's applicable warranties or warranty disclaimers for TI products.

Mailing Address: Texas Instruments, Post Office Box 655303, Dallas, Texas 75265  
Copyright © 2020, Texas Instruments Incorporated