

## MYD-Y6ULX-HMI Development Board

- 528MHz NXP i.MX 6UltraLite / 6ULL ARM Cortex-A7 Processor
- 256MB DDR3, 256MB Nand Flash
- RS232, RS485, USB Host, Device, Ethernet, TF Card, LCD, Touch Screen, Camera, RTC, IO...
- Optional MYB-Y6ULX-HMI-4GEXP IO Board adds Ethernet, WiFi/BT, 4G LTE Interface, Audio...
- Optional 7-inch LCD with Capacitive Touch Screen
- Supports Working Temperature Ranging from -40°C to 85°C
- Ready-to-Run Linux 4.1.15 OS with QT 5.6.2



Figure 1-1 MYD-Y6ULX-HMI Development Board

The [MYD-Y6ULX-HMI Development Board](#) is specially designed for MYIR's [MYD-Y6ULX-CHMI Display Panel](#) for Human Machine Interface (HMI) applications. It is powered by MYIR's [MYC-Y6ULX CPU Module](#) which is a compact System-on-Module (SoM) integrated with 528MHz [NXP i.MX6UL/6ULL ARM Cortex-A7](#) processor, 256MB DDR3, 256MB Nand Flash and Ethernet PHY.

In addition to the core components provided by the [MYC-Y6ULX](#) core board, the [MYD-Y6ULX-HMI](#) has extended multiple peripheral interfaces like RS232, RS485, USB Host/Device, 10/100Mbps Ethernet and TF card to its base board to allow communications with other devices. It also features a Camera interface and supports 16-bit LCD & 4-wire resistive or capacitive touch screen driven directly from the board circuit. The board provides two 2.0mm pitch 2\*20-pin headers for IO extension. User can customize their own IO boards to connect with the MYD-Y6ULX-HMI to further explore more functions. MYIR offers an IO board [MYB-Y6ULX-HMI-4GEXP](#) as an option for users which has extended WiFi & BT, USB based 4G LTE Module interface, Audio and GPIOs. A 7-inch LCD with capacitive touch screen is also available as an add-on option, thus making a complete solution for HMI applications.

The [MYD-Y6ULX-HMI](#) is preloaded with Linux OS. MYIR has provided plenty of resources including kernel and drivers in source code, application examples and an **MEasyHMI QT demo** for developers to start their development rapidly.

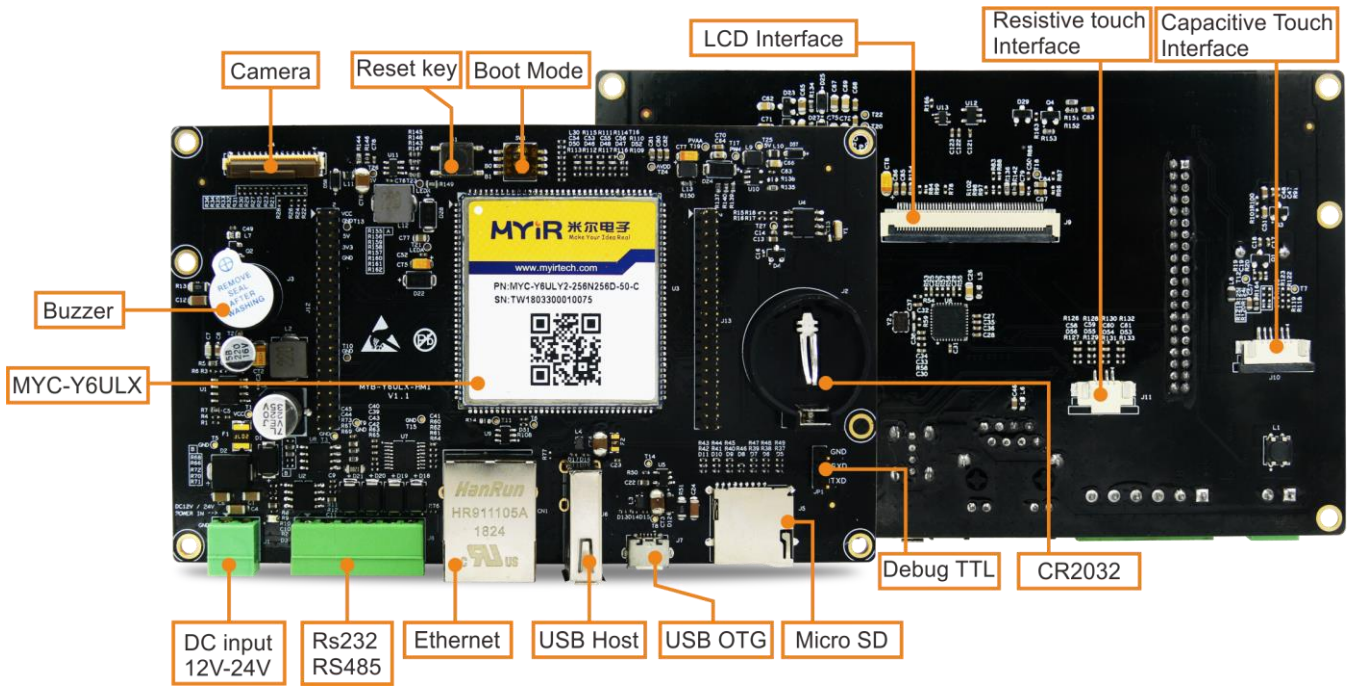

Figure 1-2 MYD-Y6ULX-HMI Development Board

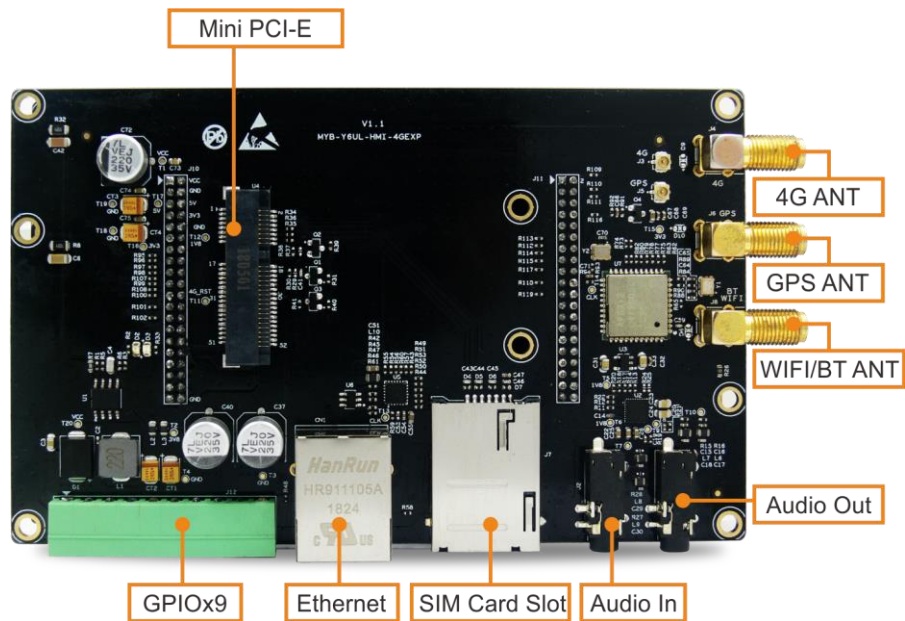
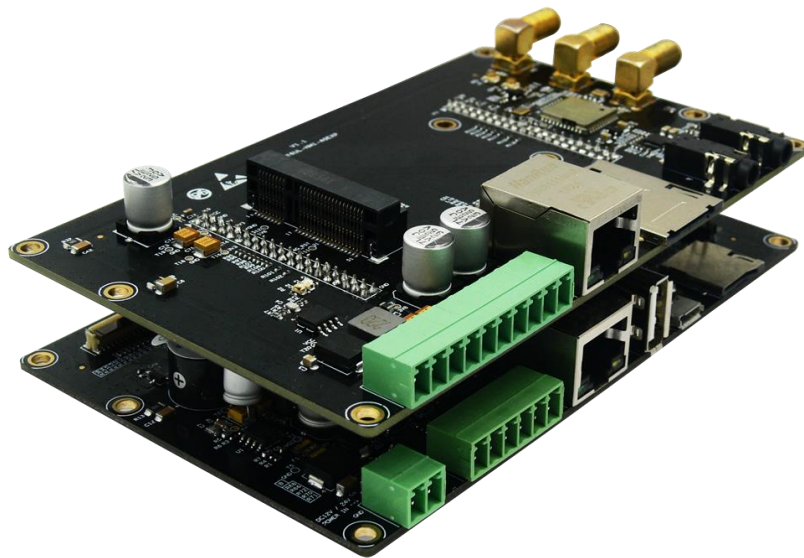

Figure 1-3 MYB-Y6ULX-HMI-4GEXP IO Board



*Figure 1-4 MYB-Y6ULX-HMI-4GEXP IO Board Mounted on MYD-Y6ULX-HMI*



*Figure 1-5 MYD-Y6ULX-CHMI Display Panel*



*Figure 1-6 MYD-Y6ULX-CHMI Display Panel + MYB-Y6ULX-HMI-4GEXP IO Board*

## Hardware Specification

The [MYC-Y6ULX CPU Module](#) on the MYD-Y6ULX-HMI Development Board is using the 14 x 14mm, 0.8 mm ball pitch, 289 MAPBGA package 528 MHz i.MX 6UltraLite / i.MX 6ULL ARM Cortex-A7 application processor which provides multiple compatible options of G0, G1, G2, G3, Y0, Y1 and Y2 sub family. The MCIMX6G2CVM05AB and MCIMX6Y2DVM05AA are optional as the default part with the board.

Expanding the i.MX 6 series, the i.MX 6UltraLite is a high performance, ultra-efficient processor family featuring an advanced implementation of a single ARM® Cortex®-A7 core, which operates at speeds up to 696 MHz. The i.MX 6UltraLite applications processor includes an integrated power management module that reduces the complexity of external power supply and simplifies power sequencing. Each processor in this family provides various memory interfaces, including 16-bit LPDDR2, DDR3, DDR3L, raw and managed NAND flash, NOR flash, eMMC, Quad SPI and a wide range of other interfaces for connecting peripherals such as WLAN, Bluetooth™, GPS, displays and camera sensors.

Feature	MCIMX6G0	MCIMX6G1	MCIMX6G2	MCIMX6G3
<b>Speed</b>	528 MHz	528 MHz	528 MHz	528 MHz
<b>Cache</b>	32 KB-I, 32 KB-D	32 KB-I, 32 KB-D 128 KB L2	32 KB-I, 32 KB-D 128 KB L2	32 KB-I, 32 KB-D 128 KB L2
<b>OCRAM</b>	128 KB	128 KB	128 KB	128 KB
<b>DRAM</b>	16-bit LP-DDR2, DDR3/DDR3L	16-bit LP-DDR2, DDR3/DDR4L	16-bit LP-DDR2, DDR3/DDR5L	16-bit LP-DDR2, DDR3/DDR6L
<b>eFuse</b>	512-bit	1024-bit	1536-bit	2048-bit
<b>NAND (BCH40)</b>	Yes	Yes	Yes	Yes
<b>EBI</b>	Yes	Yes	Yes	Yes
<b>Ethernet</b>	10/100-Mbit/s x 1	10/100-Mbit/s x 1	10/100-Mbit/s x 2	10/100-Mbit/s x 2
<b>USB</b>	OTG, HS/FS x 1	OTG, HS/FS x 2	OTG, HS/FS x 2	OTG, HS/FS x 2
<b>CAN</b>	0	1	2	2
<b>Security</b>	Basic	TRNG, Crypto Engine (AES/TDES/SHA), Secure Boot	TRNG, Crypto Engine (AES/TDES/SHA), Secure Boot	TRNG, Crypto Engine (AES with DPA/TDES/SHA/RSA), Secure Boot, tamper monitor, PCI4.0 pre-certification, OTF DRAM encryption
<b>Graphic</b>	None	None	PxP	PxP
<b>CSI</b>	None	None	24-bit Parallel CSI	24-bit Parallel CSI
<b>LCD</b>	None	None	24-bit Parallel LCD	24-bit Parallel LCD
<b>Quad SPI</b>	1	1	1	1
<b>SDIO</b>	2	2	2	2
<b>UART</b>	4	8	8	8
<b>I2C</b>	2	4	4	4
<b>SPI</b>	2	4	4	4
<b>I2S/SAI</b>	1	3	3	3
<b>S/PDIF</b>	1	1	1	1
<b>Timer/PWM</b>	Timer x 2, PWM x 4	Timer x 4, PWM x 8	Timer x 4, PWM x 8	Timer x 4, PWM x 8
<b>12-bit ADC</b>	1 x 10-ch.	1 x 10-ch.	2 x 10-ch.	2 x 10-ch.

Table 1-1 i.MX 6UltraLite Device Options

The i.MX 6ULL is a power efficient and cost optimized applications processor family featuring an advanced implementation of a single ARM Cortex-A7 core, which operates at speeds up to 900 MHz. The i.MX 6ULL applications processor includes an integrated power management module that reduces the complexity of an external power supply and simplifies power sequencing. Each processor in this family provides various memory interfaces, including 16-bit LPDDR2, DDR3, DDR3L, raw and managed NAND flash, NOR flash, eMMC, Quad SPI and a wide range of other interfaces for connecting peripherals such as WLAN, Bluetooth®, GPS, displays and camera sensors.

Feature	MCIMX6Y0	MCIMX6Y1	MCIMX6Y2
<b>Core</b>	ARM® Cortex-A7	ARM® Cortex-A7	ARM® Cortex-A7
<b>Speed</b>	528 MHz	528 MHz	528 MHz
<b>Cache</b>	32 KB-I, 32 KB-D	32 KB-I, 32 KB-D 128 KB L2	32 KB-I, 32 KB-D 128 KB L2
<b>OCRAM</b>	128 KB	128 KB	128 KB
<b>DRAM</b>	16-bit LP-DDR2, DDR3/DDR3L	16-bit LP-DDR2, DDR3/DDR4L	16-bit LP-DDR2, DDR3/DDR5L
<b>eFuse</b>	256-bit	256-bit	256-bit
<b>NAND (BCH40)</b>	Yes	Yes	Yes
<b>EBI</b>	Yes	Yes	Yes
<b>Ethernet</b>	10/100-Mbit/s x 1	10/100-Mbit/s x 1	10/100-Mbit/s x 2
<b>USB</b>	OTG, HS/FS x 1	OTG, HS/FS x 2	OTG, HS/FS x 2
<b>CAN</b>	0	1	2
<b>Graphic</b>	None	None	PxP
<b>CSI</b>	None	None	16-bit Parallel CSI
<b>LCD</b>	None	None	24-bit Parallel LCD
<b>Quad SPI</b>	1	1	1
<b>SDIO</b>	2	2	2
<b>UART</b>	4	8	8
<b>I2C</b>	2	4	4
<b>SPI</b>	2	4	4
<b>I2S/SAI</b>	1	3	3
<b>ESAI</b>	1	1	1
<b>S/PDIF</b>	1	1	1
<b>Timer/PWM</b>	Timer x 2, PWM x 4	Timer x 4, PWM x 8	Timer x 4, PWM x 8
<b>12-bit ADC</b>	1 x 10-ch.	1 x 10-ch.	2 x 10-ch.
<b>Security</b>	None	AES-128, HAB	AES-128, HAB
<b>Temperature</b>	-40°C to 105°C (Tj)	-40°C to 105°C (Tj)	-40°C to 105°C (Tj)

Table 1-2 i.MX 6ULL Device Options

The [MYD-Y6ULX-HMI Development Board](#) is using [MYC-Y6ULX CPU Module](#) as core controller board. It takes full features of i.MX 6UL/6ULL processor and the main features are characterized as below:

## Mechanical Parameters

- Dimensions: 130mm x 88mm (base board), 37mm x 39mm (CPU Module)
- PCB Layers: 6-layer design (base board), 8-layer design (CPU Module)
- Power supply: +12V/1.5A (through one 2-pin 3.81mm pitch Phoenix connector)
- Working temperature: 0~70 Celsius (commercial grade) or -40~85 Celsius (industrial grade)

## The MYD-Y6ULX-HMI Controller Board ([MYC-Y6ULX CPU Module](#))



Figure 1-7 [MYC-Y6ULX CPU Module](#) (delivered with shield cover)

## Processor

- 528MHz NXP i.MX 6UltraLite / i.MX 6ULL ARM Cortex-A7 processor (MCIMX6Y2CVM05A or MCIMX6Y2DVM05A by default)

## Memory

- 256MB DDR3 SDRAM (supports up to 1GB)
- 256MB Nand Flash (4GB eMMC Flash is optional)

## Peripherals and Signals Routed to Pins

### [MYC-Y6ULX Pinouts Description](#)

- One 10/100M Ethernet PHY
- 1.0mm pitch 140-pin stamp hole expansion interface
  - 2 x 10/100Mbps Ethernet
  - 8 x Serial ports
  - 4 x I2C
  - 2 x CAN
  - 4 x SPI
  - 8 x ADC
  - 8 x PWM
  - 3 x I2S
  - 1 x Parallel Camera Sensor Interface

- 1 x JTAG
- 1 x 24-bit LCD interface
- Up to 97 x GPIOs

Note: the peripheral signals brought out to the expansion interface are listed in maximum number. Some signals are reused. Please refer to the processor datasheet.

**The MYD-Y6ULX-HMI Development Board Base Board**

- Serial ports
  - Debug serial port (TTL)
  - 1 x RS485 serial port
  - 1 x 3-wire RS232 serial port
- USB
  - 2 x USB2.0 Host ports
  - 1 x Micro USB2.0 OTG port
- 1 x 10/100 Mbps Ethernet interface
- 1 x Camera interface
- 1 x TF card slot
- 1 x LCD interface (16-bit true color, supports MYIR’s 7-inch TFT LCD)
- 1 x Resistive Touch Screen interface
- 1 x Capacitive Touch Screen interface (supports MYIR’s 7-inch capacitive touch screen)
- Battery backed RTC
- 1 x Reset button
- 1 x Buzzer
- 2 x 2.0mm 2\*20-pin male pin headers (J12 & J13)

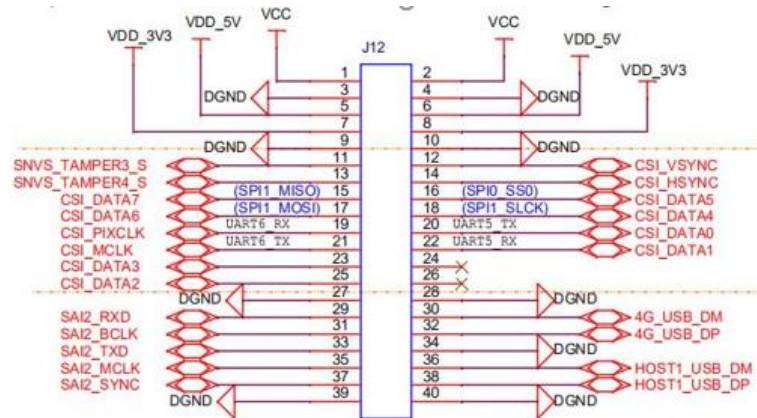

Figure 1-8 Signals of J12 pin header

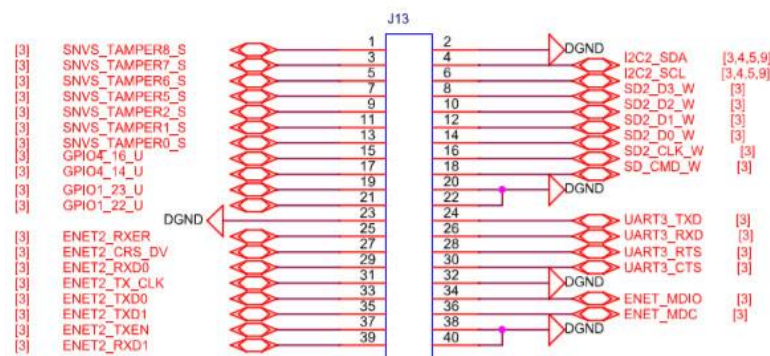

Figure 1-9 Signals of J13 pin header

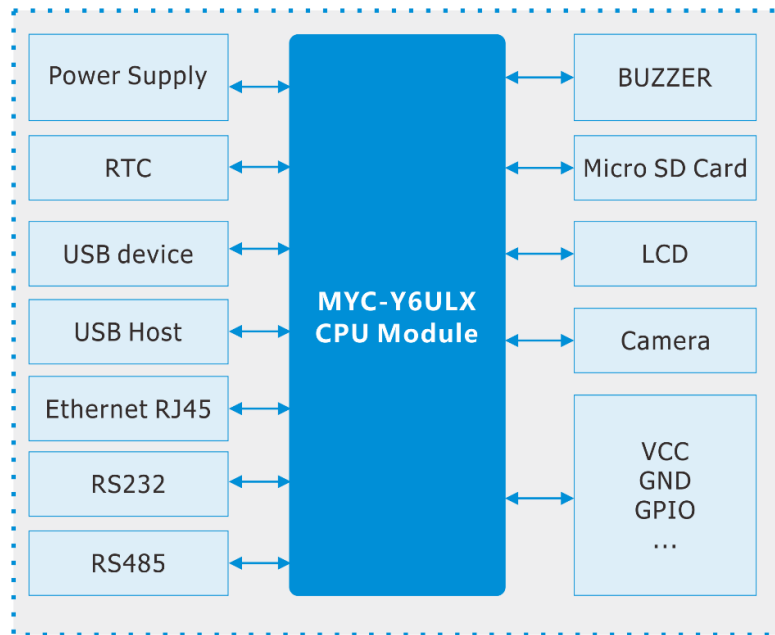

Figure 1-10 MYD-Y6ULX-HMI Development Board Function Block Diagram

**The MYB-Y6ULX-HMI-4GEXP IO Board**

MYIR also offers an optional IO Board [MYB-Y6ULX-HMI-4GEXP](#) for users to explore more functions of the [MYD-Y6ULX-HMI development board](#). The main features of the IO Board are as following:

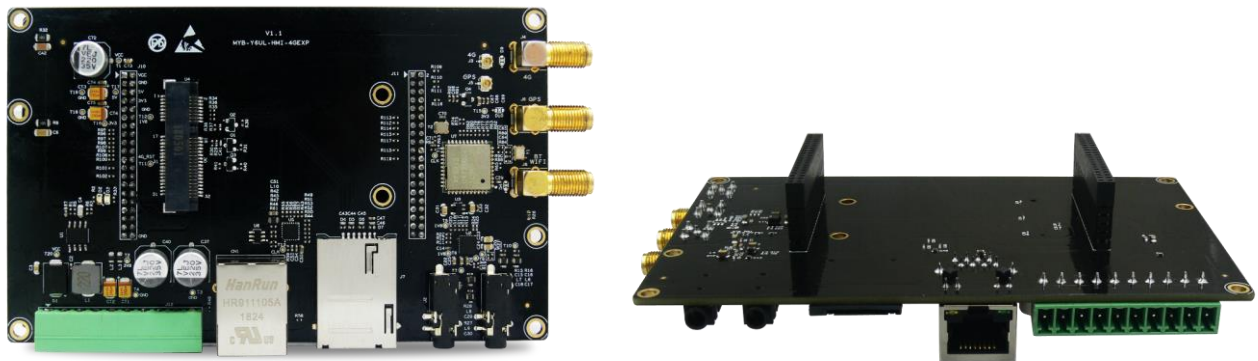

Figure 1-11 MYB-Y6ULX-4GEXP IO Board

- Dimensions: 130mm x 88mm
- PCB Layers: 4-layer design
- Working temp.: -40~85 Celsius (but WiFi/BT module supports only -30 ~85 Celsius)
- 1 x Mini PCIe interface (supports USB based 4G LTE module)
- 1 x SIM card socket
- 1 x WiFi/Bluetooth module (AP6212, cannot be supported if using eMMC on MYC-Y6ULX)
- 3 x External antenna interfaces (one for WiFi/BT, one for 4G LTE and one for GPS)
- Audio input/output
- 9 GPIOs
- 2 x 2.0mm 2\*20-pin female connectors (J10 & J11)



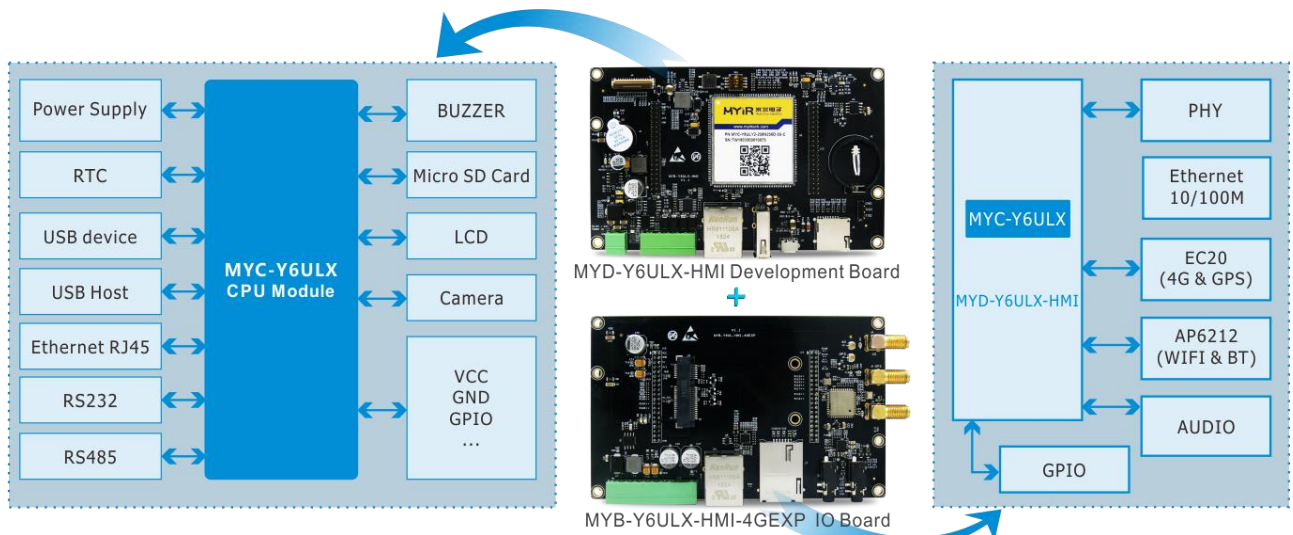

Figure 1-12 MYD-Y6ULX-CHMI Display Panel Function Block Diagram

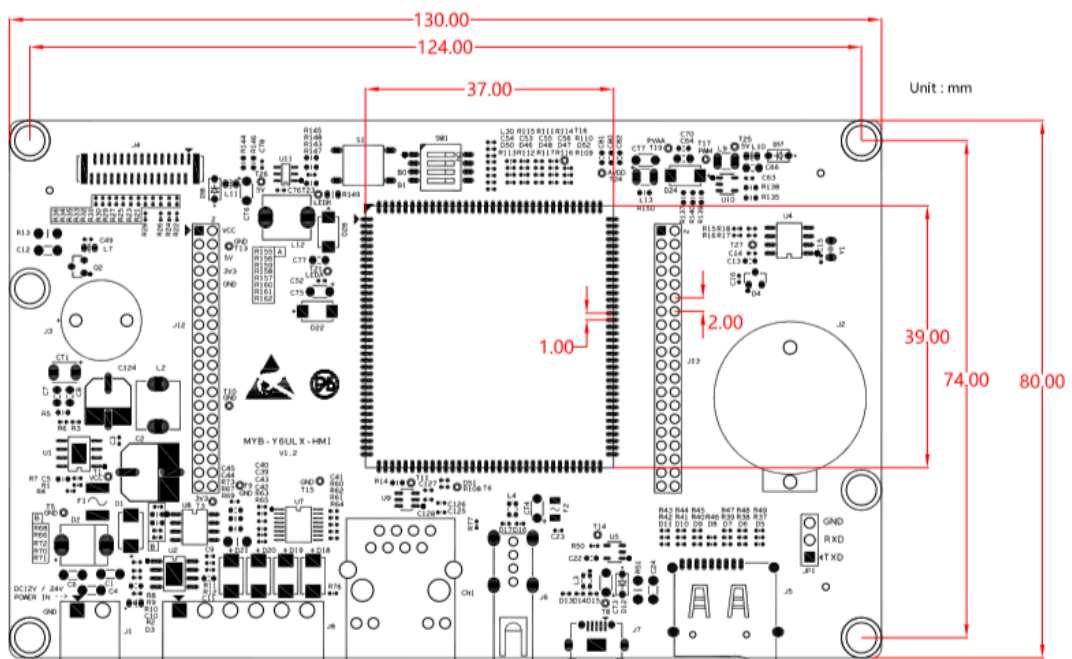

Figure 1-13 MYD-Y6ULX-HMI Dimensions Chart

## Software Features

Item	Features	Description
Bootstrap program	u-boot	The primary bootstrap (source code)
Kernel	Version	Linux 4.1.15 (source code, based on official imx_4.1.15_2.0.0_ga version)
Linux Drivers	USB	HOST and OTG driver (source code)
	Ethernet	Ethernet driver (source code)
	MMC	MMC/eMMC/TF card driver (source code)
	NandFlash	Nand Flash driver (source code)
	eMMC	eMMC driver (source code)
	WiFi & BT	AP6212 driver (source code)
	4G LTE	4G LTE Module driver (source code, USB signal based)
	Camera	Camera driver (source code, OV2659)
	LCD Controller	LCD driver (source code, supports MYIR's 7- inch LCD)
	Touch Panel	Resistive and Capacitive touch screen driver (source code, MYIR's 7- inch Touch Panel)
	RTC	RTC driver (source code)
	GPIO Button	Button driver (source code)
	UART	UART driver (source code)
	CAN	CAN driver (source code)
	RS485	RS485 driver (source code)
	Audio	Audio driver (source code, wm8904)
	SPI	SPI driver (source code)
	I2C	I2C driver (source code)
	PWM	PWM controller driver (source code)
	GPIO	GPIO driver (source code)
Watchdog	Watchdog driver (source code)	
File System	Yocto	Including QT5.6 (source code) Common file system for terminal

Application Program	GPIO LED and Key	LED and Key driver (source code)
	NET	TCP/IP Socket C/S example
	RTC	RTC example
	RS232	RS232 example
	RS485	RS485 example
	Audio	Audio example
	LCD	LCD example
	Camera	Viewing via web
	Data base sqllite3	Data storing example
	MODBUS RTU	MODBUS RTU Protocol Library
Compiler Tool Chain	Linaro GCC 4.9 hf	Binary file
	MetaToolchain	Built by Yocto, GCC 5.3 (Binary file)
	Applications Tool Chain	Built by Yocto, GCC 5.3 (Binary file)
Demo	MEasyHMI	Including examples developed by Web Server and QT for peripherals using (source code)

*Table 1-3 Software Features of MYD-Y6ULX-HMI*

**Order Information**

Item	Packing List
MYD-Y6ULX-HMI Development Board (Part No.: MYD-Y6ULY2-256N256D-50-C-HMI)	- One MYD-Y6ULX-HMI board - One 12V DC power adapter
MYD-Y6ULX-HMI Development Board (Part No.: MYD-Y6ULY2-256N256D-50-I-HMI)	
MYB-Y6ULX-HMI-4GEXP IO Board (Part No.: MYB-Y6ULX-HMI-4GEXP)	- One MYB-Y6ULX-HMI-4GEXP board - One 4G LTE antenna - One WiFi/BT antenna
MYD-Y6ULX-CHMI Display Panel (Part No.: MYD-Y6ULY2-256N256D-50-C-CHMI)	- One MYD-Y6ULX-HMI board - One 12V DC power adapter - One 7-inch LCD with Capacitive touch screen



**MYIR Tech Limited**

Room 04, 6th Floor, Building No.2, Fada Road, Yunli Smart Park, Bantian,  
Longgang District, Shenzhen, Guangdong, China 518129

E-mail: [sales@myirtech.com](mailto:sales@myirtech.com)

Phone: +86-755-22984836

Fax: +86-755-25532724

Website: <http://www.myirtech.com>